



RESTAURANT
HOTEL

We strongly believe in the uniqueness of the single individual. We do not want a homogeneous world, where everyone thinks alike.
All we do is offer our customers the opportunity to stand out by becoming unique

We do all this starting from a family production tradition of over 70 years, made of craftsmanship of the highest quality and experience, combined with the most advanced technological solutions.

We produce unique and bespoke professional tools to suit your culinary art.

Since 1947

Crediamo fermamente nell'unicità del singolo individuo. Non vogliamo un mondo omogeneo, dove tutti pensano allo stesso modo.
Tutto quello che facciamo è offrire ai nostri clienti la possibilità di distinguersi, diventando unici.

Facciamo tutto questo partendo da una tradizione familiare produttiva di oltre 70 anni, fatta di artigianato ad altissima qualità ed esperienza, unito alle più avanzate soluzioni tecnologiche.

Produciamo articoli professionali unici e su misura, per soddisfare la vostra arte culinaria.

Mepra and
Pininfarina have
created STILE, a
refined collection
for the lovers of
Italian beauty.
We created a
s e p a r a t e d
catalog, only for
this collection.

STILE

by pininfarina

Dalla collabora-
zione di Mepra e
Pininfarina, nasce
STILE, una
c o l l e z i o n e
raffinata e
innovativa per gli
amanti della
bellezza italiana.
A b b i a m o
realizzato un
catalogo a parte,
solo per questa
collezione.

Icon of timeless beauty



Cisitalia, 1947: una scultura in movimento esposta permanentemente al MoMA di New York.

Cisitalia, 1947: a sculpture in movement Exposed at MoMA in New York.

The price is forgotten, the quality remains.

Mepra Atelier



Les Etoiles

Il prezzo si dimentica, la qualità rimane



Customized
products





Mirror



O

Oro
Lucido



ON

Oro Nero
Lucido



B

Bronzo
Lucido



C

Champagne
Lucido



A

Arcobaleno
Lucido



AR

Argentato
Lucido



Ice



OI

ION

IB

IC

IA

ARI

Oro
Ice

Oro Nero
Ice

Bronzo
Ice

Champagne
Ice

Arcobaleno
Ice

Argentato
Ice



Peltro



PO

PON

PB

PC

PA

PAR

Oro
Peltro

Oro Nero
Peltro

Bronzo
Peltro

Champagne
Peltro

Arcobaleno
Peltro

Argentato
Peltro

MEPRA

S. p. A.

THE LUXURY ART

Posate



FLATWARE COUVERTS BESTECKE CUBIERTOS

- Gamma completa per ogni modello
 - Spessore elevato
 - Rebbi delle forchette lavorati internamente
 - Seghettatura lame passante per un taglio perfetto
- Each collection consists of an extensive range of pieces.
- Thick stainless steel.
 - Fork tines are polished on all sides for a lifetime of performance.
 - Knife blades have a micro-serration for an effortless cut.
- Chaque modèle est complet de toute le pièces nécessaire
- Épaisseur massifs
 - Fourchons des fourchettes intérieurement travaillés
 - Les couteaux possèdent la dentelure fin ouvragée pour une coupe facile
- Jedes Modell verfügt über eine komplette Bandbreite an Zusatzteilen
- Hohe Materialstärke
 - Exakte, maschinell gefertigte Gabelzinken
 - Genauste Ausbildung der Messerschneiden für einen perfekteren Schnitt
- Cada modelo esta completo de todo lo necesario
- Espesor macizo
 - Tenedores con púas pulidas internamente.
 - Cuchillos con hoja sierra; corte perfecto

MEPRA

S.p.A.





























Mirror



Code		mm.	inch.
01		199	7 7/8
02		199	7 7/8
03		228	9
04		176	6 7/8
05		176	6 7/8
06		203	8
07		135	5 1/8
08		108	4 1/4
09		330	13
10		235	9 1/4
11		235	9 1/4
12		228	9
13		203	8
15		150	5 7/8
16		251	9 7/8
20		195	7 7/8
21		195	7 7/8
22		235	9 1/4
23		235	9 1/4
25		185	7 1/4
35		175	6 7/8
36		228	9
37		170	6 3/4
39		175	6 7/8
40		185	7 1/4
45		183	7 1/5

Coltelli disponibili anche con manico vuoto
 Hollow handle knives available
 Couteaux disponibles aussi avec un manche creux
 Messer in Hohlheft-Ausführung erhältlich
 Cuchillo disponible también en mango hueco



Code	mm.	inch.
01 	201	7 7/8
02 	201	7 7/8
03 	230	9
04 	180	7
05 	177	7
06 	202	8
07 	139	5 1/2
08 	110	4 1/3
09 	304	12
10 	243	9 5/8
11 	243	9 5/8
15 	145	5 3/4
16 	243	9 5/8
20 	210	8 1/4
21 	192	7 1/2
22 	243	9 1/2
23 	243	9 1/2
25 	201	8
35 	180	7
36 	227	9
37 	164	6 1/2
39 	180	7
40 	175	6 7/8
45 	203	8

Tutti i pezzi di questo modello sono realizzati in forgia.
 All pieces in this range are forged.
 Toutes les pièces de ce modèle sont forgées.
 Alle Teile dieses Modells sind geschmiedet.
 Todas las piezas de este modelo son hechas en forja.

mm 9,0
ARIA



Code	mm.	inch.
01	208	8 1/5
02	208	8 1/5
03	235	9 1/4
04	185	7 1/4
05	185	7 1/4
06	205	8
07	140	5 1/2
08	120	4 3/4
09	275	10 3/5
10	250	9 3/8
11	250	9 3/8
15	155	6 1/8
16	260	10 1/4
20	210	8 1/4
21	185	7 1/4
22	250	9 3/8
23	250	9 3/8
25	201	7 3/5
26	156	6 1/2
35	185	7 1/4
36	235	9 1/4
37	183	7 1/5
39	185	7 1/4
40	180	7
45	183	7 1/4

I coltelli appoggiano sulla lama
 Knives may be set blade-down
 Les couteaux peuvent être posés debout sur leurs lames
 Durch das aussergewöhnliche Design, ist es möglich, die
 jeweiligen Messer auch hochkant, also "auf der Klinge
 stehend", abzustellen.
 Los cuchillos pueden apoyarse sobre la hoja.

Tutti i pezzi di questo modello sono realizzati in forgia
 All pieces in this range are forged
 Toutes les pièces de ce modèle sont forgées
 Alle Teile dieses Modells sind geschmiedet
 Todas las piezas de este modelo son hechas en forja

ARTE mm 8,0



Code	mm.	inch.
01	210	8 1/4
02	210	8 1/4
03	235	9 1/4
04	190	7 1/2
05	190	7 1/2
06	212	8 1/3
07	138	5 1/5
08	109	4 1/3
09	290	11 1/5
10	240	9 1/2
11	238	9 1/8
15	158	6 1/4
16	259	10 1/5
20	223	8 1/4
21	208	8 1/5
22	240	9 1/2
23	240	9 1/2
25	208	8 1/5
36	234	9 1/5
37	178	7
39	192	7 1/2
40	175	6 1/8

mm 4,0
ATENA



Code	mm.	inch.
01	200	7 7/8
02	202	8
03	221	8 3/4
04	180	7
05	180	7
06	198	7 3/4
07	135	5 1/3
08	114	4 1/2
09	312	12 1/8
10	235	9 1/4
11	240	9 1/2
15	150	5 7/8
16	255	10
20	210	8 1/4
21	202	8
22	235	9 1/4
23	235	9 1/4
25	185	7 1/4
31	114	4 1/2
35	180	7
36	221	8 3/4
37	162	6 1/5
39	180	7
40	185	7 1/4



ICE



Code	mm.	inch.
01	210	8 1/4
02	208	8 1/5
03	235	9 1/4
04	190	7 1/2
05	188	7 1/5
06	212	8 1/3
07	138	5 1/5
08	109	4 1/3
09	285	11 1/5
10	240	9 1/2
11	238	9 1/8
15	157	6 1/7
16	256	10
20	220	8 1/3
21	208	8 1/6
22	240	9 1/2
23	240	9 1/2
25	198	7 1/5
26	158	6 1/5
35	182	7 1/6
36	233	9 1/6
37	181	7 1/8
40	173	6 1/5

mm 8,0

BALI



Code	mm.	inch.
01	204	8
02	204	8
03	246	9 2/3
04	175	6 7/8
05	175	6 7/8
06	220	8 2/3
07	135	5 1/3
08	111	4 1/8
09	313	12 1/2
10	253	10
11	253	10
12	245	9 2/3
13	220	8 2/3
15	154	6
16	241	9 1/2
20	207	8 1/7
21	207	8 1/7
22	253	10
23	253	10
26	164	6 1/2
35	175	6 7/8
36	245	9 2/3
37	169	6 2/3
39	175	6 7/8
40	187	7 1/8
45	192	7 1/2

Coltelli disponibili anche con manico vuoto
 Hollow handle knives available
 Couteaux disponibles aussi avec un manche creux
 Messer in Hohlheft-Ausführung erhältlich
 Cuchillo disponible también en mango hueco



Code		mm.	inch.
01		207	8 1/7
02		207	8 1/7
03		235	9 1/4
04		180	7
05		180	7
06		204	8
07		135	5 1/3
08		114	4 1/2
09		315	12 1/5
10		250	9 7/8
11		250	9 7/8
12		235	9 1/4
13		204	8
15		155	6
16		244	9 5/8
20		180	7
21		179	7
22		250	9 7/8
23		250	9 7/8
24		140	5 1/2
25		195	7 2/3
26		155	6 1/3
35		180	7
36		224	8 5/8
37		170	6 2/3
39		180	7
40		184	7 1/4
41		165	6 1/2
45		205	8









Coltelli disponibili anche con manico vuoto
 Hollow handle knives available
 Couteaux disponibles aussi avec un manche creux
 Messer in Hohlheft-Ausführung erhältlich
 Cuchillo disponible también en mango hueco

mm 3,0
BOHEME

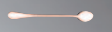

Code	mm.	inch.
01	204	8
02	203	8
03	232	9 1/8
04	185	7 1/4
05	184	7 1/4
06	210	8 1/4
07	134	5 1/4
08	107	4 1/4
09	288	11 1/2
10	240	9 3/5
11	241	9 1/2
15	158	6 1/5
16	258	10
17	198	7 7/5
21	184	7 1/4
25	195	7 2/3
35	182	7 1/6
36	234	9 1/5
37	172	6 1/4



Code	mm.	inch.
01 	201	7 7/8
02 	201	7 7/8
03 	232	9 1/8
04 	170	6 2/3
05 	175	6 7/8
06 	199	7 7/8
07 	133	5 1/4
08 	110	4 1/3
10 	250	9 5/8
11 	255	10
15 	152	6
20 	210	8 1/4
21 	201	7 7/8
22 	250	9 5/8
23 	250	9 5/8
25 	195	7 3/4
26 	155	6 1/8
36 	224	8 7/8
37 	171	6 3/4
39 	170	6 2/3
45 	182	7 1/8

mm 4,0
DIAMANTE



Code	mm.	inch.
01	206	8 1/5
02	206	8 1/5
03	240	9 3/5
04	178	7
05	178	7
06	214	8 2/5
07	133	5 1/4
08	113	4 2/5
09	315	12 2/5
10	245	9 2/5
11	245	9 2/5
12	240	9 3/5
13	214	8 2/5
15	155	6
16	241	9 1/2
20	210	8 1/4
21	206	8 1/5
22	240	9 3/5
23	244	9 2/5
25	208	8 1/6
26	156	6 1/7
35	178	7
36	240	8 1/5
37	169	6 2/5
39	178	7
40	183	7 1/5
45	177	7



PELTRO

Coltelli disponibili anche con manico vuoto
 Hollow handle knives available
 Couteaux disponibles aussi avec un manche creux
 Messer in Hohlheft-Ausführung erhältlich
 Cuchillo disponible también en mango hueco



Code		mm.	inch.
01		200	7 7/8
02		200	7 7/8
03		225	8 7/8
04		175	6 7/8
05		180	7
06		200	7 7/8
07		135	5 1/3
08		110	4 1/3
09		298	11 3/4
10		235	9 1/4
11		245	9 5/8
15		150	6
16		252	10
20		185	7 1/4
21		185	7 1/4
22		235	9 1/4
23		235	9 1/4
25		185	7 1/4
35		180	7
36		225	8 7/8
37		193	7 5/8
39		178	7
40		180	7
45		189	7 4/5

- ICE
- ORO
ICE
- ORO
NERO
- BRONZO
- CHAMPAGNE
- ARCOBALENO

mm 4,0
DUE



Code		mm.	inch.
01		205	8
02		206	8 1/8
03		235	9 1/4
04		175	6 7/8
05		175	6 7/8
06		202	8
07		134	5 1/4
08		111	4 1/3
09		302	11 7/8
10		231	9
11		233	9 1/8
15		157	6 1/8
16		241	9 1/2
20		184	7 1/4
21		175	6 7/8
22		231	9
23		231	9
25		195	7 3/8
36		235	9 1/4
37		175	6 7/8
39		175	6 7/8
40		173	6 7/8



Code		mm.	inch.
01		203	8
02		200	7 7/8
03		220	8 2/3
04		178	7
05		185	7 1/4
06		195	7 2/3
07		135	5 1/3
08		113	4 1/2
09		310	12 1/3
10		245	9 2/3
11		241	9 1/2
15		150	5 4/5
16		255	10
20		197	7 3/4
21		185	7 1/3
22		245	9 2/3
23		245	9 2/3
25		201	8
35		178	7
36		220	8 2/3
37		195	7 2/3
39		178	7
40		180	7

mm 4,0
ENERGIA



Code	mm.	inch.
01	209	8 1/5
02	209	8 1/5
03	240	9 1/2
04	180	7
05	180	7
06	214	8 2/5
07	136	5 1/3
08	114	4 1/2
09	315	12 1/5
10	250	9 7/8
11	250	9 7/8
12	240	9 1/2
13	214	8 2/5
15	155	6
16	243	9 1/2
20	210	8 1/4
21	207	8 1/7
22	250	9 7/8
23	250	9 7/8
25	194	7 2/3
26	155	6 1/3
35	190	7 1/2
36	227	9
37	172	6 3/4
39	180	7
40	184	7 1/4
44	165	6 1/2
45	208	8 1/6



Coltelli disponibili anche con manico vuoto
 Hollow handle knives available
 Couteaux disponibles aussi avec un manche creux
 Messer in Hohlheft-Ausführung erhältlich
 Cuchillo disponible también en mango hueco



Code		mm.	inch.
01		205	8
02		200	7 7/8
12		215	8 4/5
04		193	7 1/5
05		178	7
13		192	7 1/2
07		138	5 4/5
09		293	11 1/2
10		249	9 4/5
11		249	9 4/5
15		172	6 3/4
16		252	10
20		211	8 1/3
21		204	8
40		201	7 4/5



Angelo Mangiarotti

Posata realizzata a manico vuoto.
 Hollow handle manufactured cutlery.
 Couvert réalisée avec les manches
 vides.
 Bestecke in Hohlheft-Ausführung
 verarbeitet.
 Cubierto hecha en mango hueco.

ERGONOMICA

1322



Code	mm.	inch.
01	210	8 1/4
02	210	8 1/4
03	234	9 1/5
04	190	7 1/2
05	187	7 1/3
06	208	8 1/5
07	142	5 1/5
08	120	4 1/4
09	300	11 1/5
10	255	10
11	250	9 1/6
15	160	6 1/3
16	280	11
20	212	8 1/3
21	186	7 1/3
22	255	10
23	255	10
25	195	7 1/3
35	188	7 1/5
36	234	9 1/5
37	198	7 1/5
39	190	7 1/2
40	191	7 1/2
45	193	7 1/5

I coltelli appoggiano sulla lama
 Knives may be set blade-down
 Les couteaux peuvent être posés debout sur leurs lames
 Durch das aussergewöhnliche Design, ist es möglich, die
 jeweiligen Messer auch hochkant, also "auf der Klinge
 stehend", abzustellen.
 Los cuchillos pueden apoyar sobre la hoja.

Tutti i pezzi di questo modello sono realizzati in forgia
 All pieces in this range are forged
 Toutes les pièces de ce modèle sont forgées
 Alle Teile dieses Modells sind geschmiedet
 Todas las piezas de este modelo son hechas en forgia



ADV
Astier de Villatte

mm 3,0
GINEVRA



Code	mm.	inch.
01	195	7 7/8
02	195	7 7/8
03	218	8 5/8
04	173	6 7/8
05	173	6 7/8
06	195	7 7/8
07	130	5 1/8
08	112	4 3/8
09	299	11 3/4
10	234	9 1/8
11	234	9 1/8
15	154	6
16	251	9 7/8
20	197	7 3/4
21	195	7 7/8
22	234	9 1/8
23	234	9 1/8
25	185	7 1/8
35	175	6 7/8
36	218	8 5/8
37	153	6
39	173	6 7/8
40	184	7 1/4











Code		mm.	inch.
01		202	8
02		202	8
03		231	9
04		176	6 1/5
05		176	6 1/5
06		204	8
07		138	5 1/5
08		106	4 1/6
09		330	13
10		235	9 1/4
11		235	9 1/4
15		150	5 1/5
16		251	9 1/5
20		202	8
21		202	8
22		235	9 1/4
23		235	9 1/4
25		185	7 1/4
36		210	8 1/4
37		185	7 1/4
39		182	7 1/6
40		185	7 1/4

mm 4,0
IMMAGINA



Code		mm.	inch.
01		203	8
02		203	8
03		210	8 1/4
04		177	7
05		177	7
06		190	7 1/2
07		133	5 1/4
08		113	4 1/5
09		308	12 1/8
10		237	9 1/3
11		237	9 1/3
15		157	6 1/6
16		248	9 1/4
18		241	9 1/2
20		203	8
21		203	8
22		237	9 1/3
23		237	9 1/3
24		134	5 1/4
25		185	7 1/4
35		177	7
37		177	7
39		177	7
40		187	7 1/3
41		177	7



Code		mm.	inch.
01		207	8 1/7
02		201	7 7/9
03		219	8 3/5
04		178	7
07		134	5 1/4
08		120	4 3/4
15		135	5 1/3
21		210	8 1/4

Arch. Katja Bremkamp

The asymmetrical and rather unfamiliar shape of this cutlery range was influenced by the way we handle certain situations relating to the table routine. I was looking at the movements of the hands when dishing food out of bowls, when serving onto a plate and how this movement alters when food is conveyed into the mouth. Each piece reflects these movements individually, referring to their purposes and their "actions", as some pieces are more asymmetrical than others. The overall asymmetrical shape of this range therefore supports the comfortable handling of cutlery and also acts as guide to the person who is using it.

La forma asimmetrica e non convenzionale di questo modello è stata influenzata dall'osservazione dei comportamenti e delle routine legate al consumo del cibo a tavola. Ho guardato i movimenti delle mani durante la disposizione del cibo sul piatto, la raccolta del boccone e l'accompagnamento alla bocca. Ogni pezzo riflette individualmente questi movimenti, riferendosi al loro scopo e alle loro azioni; questo spiega il motivo per cui alcuni pezzi sono più asimmetrici di altri. Oltretutto, l'asimmetria di questa linea avvantaggia la maneggevolezza della posata in modo da guidare la persona che la usa.



ICE

mm 3,0
KATJA



Code	mm.	inch.
01	208	8 1/5
02	208	8 1/5
03	235	9 1/4
04	180	7
05	180	7
06	210	8 1/4
07	133	5 1/4
08	115	4 1/2
09	315	12 1/5
10	248	9 3/4
11	245	9 2/3
12	235	9 1/4
13	210	8 1/4
15	156	6 1/2
16	242	9 1/2
20	210	8 1/4
21	210	8 1/4
22	248	9 3/4
23	248	9 3/4
24	134	5 1/4
25	205	8
26	156	6 1/2
35	180	7
36	235	9 1/4
37	170	6 2/3
39	180	7
40	185	7 1/4
44	175	6 2/3
45	180	7

Coltelli disponibili anche con manico vuoto
 Hollow handle knives available
 Couteaux disponibles aussi avec un manche creux
 Messer in Hohlheft-Ausführung erhältlich
 Cuchillo disponible también en mango hueco

LEONARDO mm 4,0



Code		mm.	inch.
01		205	8
02		205	8
03		233	9 1/6
04		179	7
05		179	7
		200	7 1/6
		135	5 1/6
		113	4 1/6
		316	12 1/6
		239	9 1/6
		245	9 1/6
		160	6 1/6
		244	9 1/6
		205	8
		208	8 1/6
		239	9 1/6
		239	9 1/6
		201	8
		158	6 1/6
		155	6 1/6
36		233	9 1/6
37		163	6 1/6
39		179	7
40		182	7 1/6
45		179	7



Maurizio Duranti

mm 3,5

LEVANTINA



Code	mm.	inch.
01	200	7 7/8
02	203	8
03	235	9 1/4
04	178	7
05	180	7
06	205	8
07	135	5 1/3
08	115	4 1/2
09	305	12
10	245	9 2/3
11	245	9 2/3
15	150	6
16	246	9 2/3
20	200	7 7/8
21	187	7 1/2
22	245	9 2/3
23	245	9 2/3
25	185	7 1/3
35	178	7
36	235	9 1/4
37	178	7
39	178	7
40	190	7 1/2

- ICE
- ORO ICE
- ORO NERO
- BRONZO
- CHAMPAGNE
- ARCOBALENO

Coltelli disponibili anche con manico vuoto
 Hollow handle knives available
 Couteaux disponibles aussi avec un manche creux
 Messer in Hohlheft-Ausführung erhältlich
 Cuchillo disponible también en mango hueco

Code	mm.	inch.
01	208	8 1/5
02	208	8 1/5
03	224	8 7/5
04	183	7 1/5
05	183	7 1/5
06	195	7 2/5
07	135	5 1/5
08	115	4 1/2
09	293	11 1/2
10	265	10 2/5
11	265	10 2/5
12	224	8 7/5
13	195	7 2/5
15	152	6
16	257	10 1/5
20	223	8 3/4
21	209	8 1/5
22	265	10 2/5
23	265	10 2/5
25	201	8
26	152	6
35	183	7 1/5
36	224	8 7/5
37	171	6 3/4
39	183	7 1/5
40	180	7



ICE



**Diciottesimo
 Premio Compasso d'Oro
 ADI**

Mediterranea
 Posate
Maurizio Duranti
 Designer
Mepra spa
 Produttore

**Selezione d'onore
 Compasso d'Oro
 ADI 1998**

mm 3,5
MEDITERRANEA



Code	mm.	inch.
01	209	8 1/5
02	209	8 1/5
03	235	9 1/4
04	180	7
05	180	7
06	215	8 2/5
07	136	5 1/5
08	114	4 1/2
09	315	12 1/5
10	250	9 5/6
11	250	9 5/6
12	235	9 1/4
13	204	8
15	155	6 1/5
16	243	9 1/2
18	253	10
19	251	9 5/6
20	210	8 1/4
21	207	8 1/7
22	250	9 5/6
23	250	9 5/6
24	140	5 1/2
25	195	7 2/5
26	155	6 1/5
35	190	7 1/2
36	224	8 5/6
37	170	6 2/5
39	180	7
40	184	7 1/4
44	165	6 1/2
45	208	8 1/6

Coltelli disponibili anche con manico vuoto
 Hollow handle knives available
 Couteaux disponibles aussi avec un manche creux
 Messer in Hohlheft-Ausführung erhältlich
 Cuchillo disponible también en mango hueco



Code		mm.	inch.
01		211	8 1/3
02		211	8 1/3
03		239	9 1/5
04		181	7 1/8
05		181	7 1/8
06		215	8 1/5
07		135	5 1/3
08		114	4 1/2
09		314	12 1/3
10		250	9 1/6
11		250	9 1/6
15		158	6 1/5
16		241	9 1/2
20		213	8 1/5
21		211	8 1/3
22		250	9 1/6
23		250	9 1/6
25		201	8
26		159	6 1/4
35		189	7 1/5
36		235	9 1/4
37		174	6 1/8
39		189	7 1/5
40		190	7 1/2
45		189	7 1/5
49		149	5 1/8

mm 4,0
MORETTO



Code	mm.	inch.
01	201	8
02	201	8
03	219	8 1/5
04	180	7
05	180	7
06	195	7 1/3
07	140	5 1/2
08	113	4 1/5
09	320	12 1/5
10	245	9 1/3
11	245	9 1/3
15	153	6
16	256	10
20	213	8 1/5
21	206	8 1/3
22	245	9 1/3
23	245	9 1/3
25	201	8
35	180	7
36	219	8 1/5
37	195	7 1/3
39	180	7
40	190	7 1/2

Giulio Iacchetti

Code		mm.	inch.
01		200	7 7/8
02		204	8
03		230	9
04		180	7
05		180	7
06		204	8
07		135	5 1/3
08		113	4 4/5
09		310	12 1/2
10		240	9 1/2
11		245	9 2/3
15		150	5 7/8
16		252	10
20		222	8 3/4
21		203	8
22		240	9 1/2
23		240	9 1/2
25		201	8
35		180	7
36		230	9
37		204	8
39		180	7
40		180	7



I coltelli appoggiano sulla lama
 Knives may be set blade-down
 Les couteaux peuvent être posés debout sur leurs lames
 Durch das aussergewöhnliche Design, ist es möglich, die jeweiligen Messer auch hochkant, also "auf der Klinge stehend", abzustellen.
 Los cuchillos pueden apoyar sobre la hoja

mm 4,0
MOVIDA

























Code	mm.	inch.
01	201	7 7/8
02	201	7 7/8
03	232	9 1/8
04	170	6 2/3
05	175	6 7/8
06	199	7 7/8
07	133	5 1/4
08	110	4 1/3
09	314	12 1/3
10	250	9 7/8
11	255	10
12	232	9 1/8
13	199	7 7/8
15	152	6
16	245	9 2/3
20	170	6 2/3
21	173	6 7/8
22	250	9 7/8
23	250	9 7/8
25	195	7 3/4
26	155	6 1/8
35	175	6 7/8
36	224	8 7/8
37	171	6 3/4
39	170	6 2/3
40	190	7 1/2
45	182	7 1/8



ICE

Coltelli disponibili anche con manico vuoto
 Hollow handle knives available
 Couteaux disponibles aussi avec un manche creux
 Messer in Hohlheft-Ausführung erhältlich
 Cuchillo disponible también en mango hueco



Code	mm.	inch.
01 	210	8 1/4
02 	208	8 1/5
03 	236	9 1/4
04 	188	7 1/5
05 	190	7 1/2
06 	214	8 1/5
07 	138	5 1/5
08 	109	4 1/3
09 	285	11 1/5
10 	240	9 1/2
11 	238	9 1/8
12 	230	9
15 	158	6 1/5
16 	259	10 1/5
20 	224	8 1/5
21 	208	8 1/6
22 	240	9 1/2
23 	240	9 1/2
25 	198	7 1/5
26 	159	6 1/4
35 	183	7 1/5
36 	244	9 1/8
37 	180	7
40 	172	6 1/4

mm 4,5
NEVE



Coltelli disponibili anche con manico vuoto
 Hollow handle knives available
 Couteaux disponibles aussi avec un manche creux
 Messer in Hohlheft-Ausführung erhältlich
 Cuchillo disponible también en mango hueco

Code	mm.	inch.
01	205	8
02	205	8
03	230	9
04	175	6 ⁷ / ₈
05	175	6 ⁷ / ₈
06	203	8
07	133	5 ¹ / ₄
08	112	4 ¹ / ₅
09	310	12 ¹ / ₅
10	254	10
11	255	10
12	230	9
13	203	8
15	152	6
16	243	9 ⁵ / ₈
20	206	8 ¹ / ₃
21	206	8 ¹ / ₃
22	254	10
23	254	10
24	135	5 ¹ / ₃
25	195	7 ¹ / ₃
26	160	6 ¹ / ₃
27	160	6 ¹ / ₃
28	180	7
35	175	6 ⁷ / ₈
36	233	9 ¹ / ₆
37	171	6 ¹ / ₄
39	175	6 ⁷ / ₈
40	188	7 ¹ / ₅
44	165	6 ¹ / ₂
45	175	6 ⁷ / ₈



Code		mm.	inch.
01		197	7 7/8
02		197	7 7/8
03		223	8 7/8
04		174	6 7/8
05		175	6 7/8
06		197	7 7/8
07		133	5 1/4
10		235	9 1/4
11		235	9 1/4
15		157	6 1/8
16		254	10
22		233	9 1/8
23		233	9 1/8
20		198	7 7/8
21		195	7 3/8
26		156	6 1/8
40		185	7 1/4

mm 3,0
OFFICINA



Code	mm.	inch.
01	207	8 1/8
02	207	8 1/8
03	236	9 1/4
04	179	7
05	179	7
06	213	8 3/8
07	134	5 1/4
08	113	4 3/8
09	300	11 7/8
10	248	9 3/4
11	248	9 3/4
15	155	6 1/8
16	257	10 1/8
20	179	7
21	179	7
22	248	9 3/4
23	248	9 3/4
25	195	7 3/8
26	155	6
35	175	6 7/8
36	227	9
37	172	6 3/4
39	170	6 3/8
40	180	7
45	179	7



Code	mm.	inch.
01	209	8 1/5
02	209	8 1/5
03	235	9 1/4
04	180	7
05	180	7
06	204	8
07	136	5 1/3
08	114	4 1/2
09	315	12 1/5
10	250	9 7/8
11	250	9 7/8
12	235	9 1/4
13	204	8
15	155	6
16	243	9 1/2
20	210	8 1/4
21	207	8 1/7
22	250	9 7/8
23	250	9 7/8
25	195	7 2/3
26	155	6 1/3
35	190	7 1/2
36	235	9 1/4
37	170	6 2/3
39	180	7
40	184	7 1/4
44	165	6 1/2
45	180	7

Coltelli disponibili anche con manico vuoto
 Hollow handle knives available
 Couteaux disponibles aussi avec un manche creux
 Messer in Hohlheft-Ausführung erhältlich
 Cuchillo disponible también en mango hueco

mm 4,0 **RAFFAELLO**



Code		mm.	inch.
01		205	8
02		205	8
03		236	9 1/3
04		180	7
05		180	7
06		200	7 7/8
07		135	5 1/3
08		115	4 1/2
09		320	12 2/5
10		250	9 7/8
11		250	9 7/8
12		236	9 1/3
13		200	7 7/8
15		155	6 1/8
16		242	9 1/2
20		180	7
21		180	7
22		250	9 7/8
23		250	9 7/8
25		195	7 2/3
26		155	6 1/8
35		180	7
36		224	8 2/3
37		170	6 2/3
39		180	7
40		185	7 1/4
44		165	6 1/2
45		208	8 1/8

Coltelli disponibili anche con manico vuoto
 Hollow handle knives available
 Couteaux disponibles aussi avec un manche creux
 Messer in Hohlheft-Ausführung erhältlich
 Cuchillo disponible también en mango hueco



Code	mm.	inch.
01	204	8
02	204	8
03	239	9 1/5
04	175	6 7/8
05	175	6 7/8
06	203	8
07	133	5 1/4
08	109	4 1/3
09	313	12 1/3
10	232	9 1/8
11	232	9 1/8
12	239	9 1/5
13	203	8
15	156	6 1/7
16	244	9 3/5
18	242	9 1/2
19	240	9 2/5
20	206	8 1/5
21	203	8
22	232	9 1/8
23	232	9 1/8
24	134	5 1/4
25	207	8 1/7
26	159	6 1/4
35	190	7 1/2
36	239	9 1/5
37	180	7
39	175	6 7/8
40	188	7 3/5
45	208	8 1/5

Coltelli disponibili anche con manico vuoto
 Hollow handle knives available
 Couteaux disponibles aussi avec un manche creux
 Messer in Hohlheft-Ausführung erhältlich
 Cuchillo disponible también en mango hueco

mm 4,0
SOLE



Code	mm.	inch.
01	208	8 1/5
02	208	8 1/5
03	234	9 1/5
04	185	7 1/4
05	183	7 1/5
06	208	8 1/5
07	138	5 2/5
08	109	4 1/3
09	317	12 1/2
10	240	9 1/2
11	245	9 2/3
15	157	6 1/5
16	240	9 1/2
20	182	7 1/6
21	175	6 2/3
22	240	9 1/2
23	240	9 1/2
25	185	7 1/4
40	175	6 2/3



Code		mm.	inch.
01		203	8
02		202	8
03		232	9 1/8
04		181	7 1/8
05		180	7
06		204	8
07		138	5 3/5
08		115	4 1/2
09		285	11 1/5
10		246	9 2/5
11		244	9 3/8
15		151	6
16		248	9 3/4
20		200	7 7/8
21		179	7
22		245	9 2/5
23		245	9 2/5
35		178	7
36		232	9 1/8
37		178	7
39		182	7 1/8
45		184	7 1/4

mm 3,0
STIRIA



Code	mm.	inch.
01	204	8
02	201	7 7/8
03	231	9
04	184	7 1/4
05	182	7 1/5
06	209	8 1/5
07	135	5 1/3
08	110	4 1/3
09	280	11
10	231	9
11	234	9 1/5
15	153	6
16	260	10 1/4
20	197	7 3/4
21	201	7 7/8
25	185	7 1/3
35	178	7
36	230	9
37	172	6 3/4

STOCCOLMA mm 3,0

Giulio Iacchetti



Code		mm.	inch.
01		200	7 7/8
02		200	7 7/8
03		211	8 1/3
04		177	7
05		177	7
06		189	7 4/5
07		135	5 1/3
08		112	4 4/5
09		295	11 3/5
10		240	9 1/2
11		240	9 1/2
13		189	7 4/5
15		150	5 4/5
16		256	10
20		215	8 4/5
21		199	7 7/5
22		240	9 1/2
23		240	9 1/2
25		201	8
37		189	7 4/5
39		177	7
40		183	7 1/5

Coltelli disponibili anche con manico vuoto
 Hollow handle knives available
 Couteaux disponibles aussi avec un manche creux
 Messer in Hohlheft-Ausführung erhältlich
 Cuchillo disponible también en mango hueco

mm 3,0
SVEVA





I modelli delle due pagine seguenti, sono già disponibili in magazzino nella versione satinata, ICE. Tutti gli altri modelli possono essere forniti in versione ICE, a richiesta, senza quantità minima

The models on the two following pages are already available in stock in the satin ICE version. All the other models can be supplied on request in the ICE version, without minimum quantity.

Les modèles des deux pages suivantes sont déjà disponible en stock dans la version avec la surface de fin brossée, ICE. Tous les autres modèles peuvent être fournis en version ICE, sur demande, sans quantité minimum.

Die Modelle auf den folgenden zwei Seiten sind Ausführungen in der matte, gebürstete ICE Oberfläche auf Lager bereits. Alle anderen Modelle können auf Anfrage ohne Mindestmenge in der ICE-Version geliefert werden

Los modelos de las dos páginas siguientes sonya disponible en el almacén en la versión ICE, con la superficie satinada. Todos los otros modelos se pueden suministrar en la versión ICE, bajo pedido, sin cantidad mínima.

Ice



45 DUE ICE



41 ITALIA ICE



39 LEVANTINA ICE



47 LINEA ICE



57 GINEVRA ICE



42 NATURA ICE



40 MEDITERRANEA ICE



53 AVANGUARDIA ICE



Peltro





I modelli di queste pagine, sono già disponibili in magazzino nella versione antichizzata, PELTRO. Tutti gli altri modelli possono essere forniti in versione PELTRO, a richiesta, senza quantità minima

The models on this pages are already available in stock in the antiqued PELTRO version. All the other models can be supplied on request in the PELTRO version, without minimum quantity.







Oro



DESIGNPREIS
2009

NOMINEE

La speciale finitura non è ottenuta con metodi tradizionali come verniciatura o bagno galvanico, ma con un processo di impiantazione molecolare a base di titanio, frutto della ricerca aerospaziale.

Il prodotto è garantito per il lavaggio in lavastoviglie, non si macchia, non si ossida e resiste alla corrosione.

Unlike products that are coated or made with a galvanic process, our's is obtained using a titanium based molecular embedding process originally developed through aerospace research.

The product is dishwasher-safe, will not stain or oxidize and is highly resistant to corrosion.

Le produit n'est pas enduit ou fait avec un processus galvanique, Il est obtenu avec un processus à base de titane de d'implantation Moléculaire qui est le résultat de la recherche aérospatiale.

Le produit passe au lave-vaisselle, ne rouille pas ou ne s'oxyde pas et ne marque pas.

Die hier und vorher abgebildeten Bestecke, die mit einer Oberfläche aus Titan versehen sind, haben exakt die Farbe von Gold (ORO ICE), tiefem Schwarz (ORO NERO) und Bronze (BRONZO), was der Gestaltung von Tischen und Wohnräumen völlig neue Akzente verleiht. Das angewendete Veredelungsverfahren (P.V.D.) kommt aus der Raumfahrttechnik und war bisher bei der Gestaltung von Tabletop-Artikeln noch nie nicht angewendet worden bzw. völlig unbekannt.

Diese Produkte haben Dank des Titans eine 4 mal so harte Oberfläche wie Edelstahl, sehen nicht nur schön aus, sondern sind absolut robust und für den täglichen Gebrauch bestens geeignet.

Anfang des Jahres 2008 bekamen die Besteckmodell den begehrten Designpreis "Design Plus 2008" verliehen

El acabado especial no se obtiene de métodos tradicionales como barnizados o baño galvanico, se obtiene mediante un proceso de implantación molecular a base de titanio, fruto de la búsqueda aeroespacial.

El producto esta garantizado para el lavado en lava-vajillas, no se mancha, no se oxida y es resistente a la corrosión.



88 DUE ORO



89 LINEA ORO

I modelli di queste pagine, sono già disponibili in magazzino nella versione Oro. Tutti gli altri modelli possono essere forniti in versione Oro, a richiesta, senza quantità minima

The models on this pages are already available in stock in the Gold version. All the other models can be supplied on request in the Gold version, without minimum quantity.

Les modèles des cettés pages sont déjà disponible en stock dans la version Oro. Tous les autres modèles peuvent être fournis en version Oro, sur demande, sans quantité minimum.

Die Modelle auf diesei Seiten sind Ausführungen in der Oro, Oberfläche auf Lager bereits. Alle anderen Modelle können auf Anfrage ohne Mindestmenge in der Oro-Version geliefert werden

Los modelos de estas páginas son ya disponible en el almacén en la versión Oro. Todos los otros modelos se pueden suministrar en la versión Oro, bajo pedido, sin cantidad mínima.

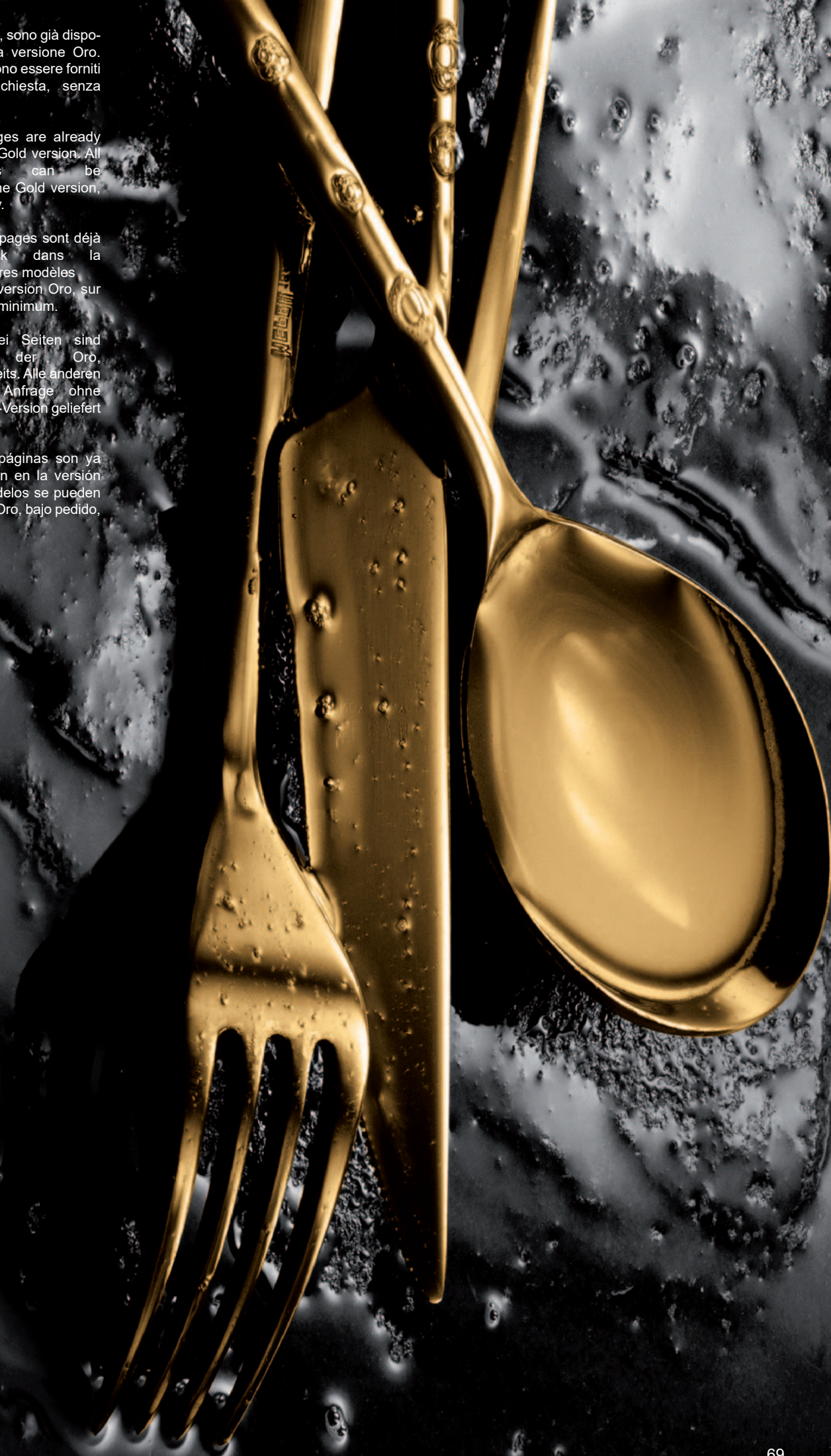



92 DUE CHAMPAGNE



86 DUE ORO NERO



93 LINEA CHAMPAGNE



87 LINEA ORO NERO



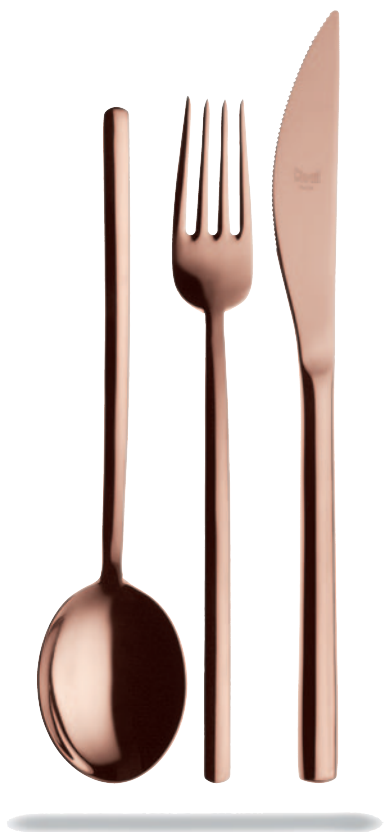

90 DUE BRONZO



80 DUE ICE ORO

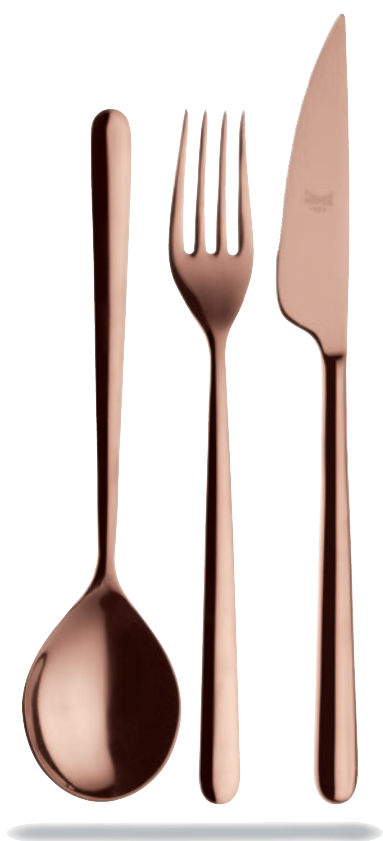

91 LINEA BRONZO



81 LINEA ICE ORO



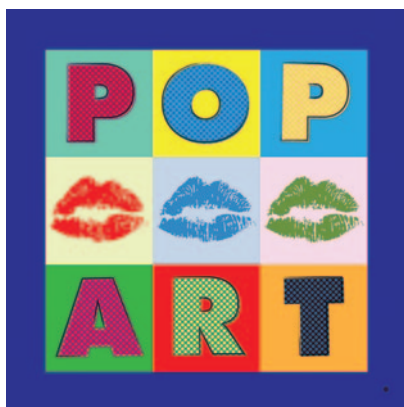

94 DUE ARCOBALENO



99 LINEA ARCOBALENO



Collezione





40

Mestolino per Salsa
Gravy ladle
Cuillère à sauce
Saucenöffel
Cacillo para salsaera

Si usa per servire
salse e condimenti
dalla salsiera
It is used to take sau-
ces and aromatic con-
diments from the gravy
boat.



16

Pala per Torta
Cake trowel
Pelle à tarte
Tortenheber
Pala tarta

Si usa per tagliare e
servire torte e semi-
freddi
It is used to portion
and serve cakes or
"semifreddi" (some
kinds of Italian ice-
cream).

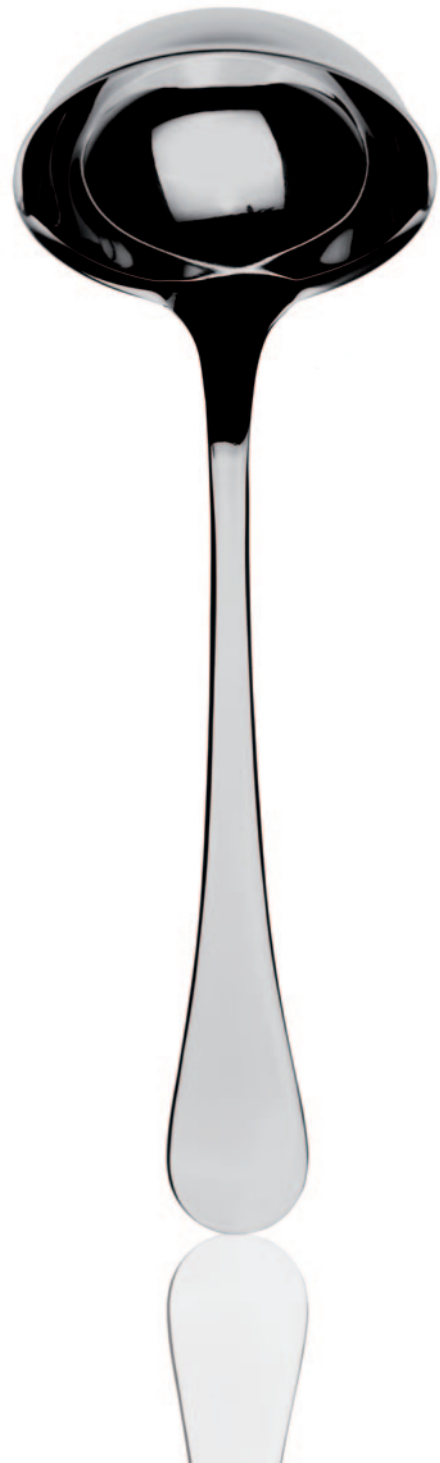

09

Mestolo a servire
Ladle
Louche
Suppenschöpfer
Cazo Sopa

Si usa per servire mine-
stre dalla zuppiera al
piatto fondo
It's used to serve soups
from the tureen to the
(soup) plate.



01

Cucchiaio Tavola
Table spoon
Cuillère table
Tafellöffel
Cuchara de mesa

Cucchiaio per minestre e primi piatti
Spoon for soups and first courses



04

Cucchiaio Frutta
Dessert spoon
Cuillère à dessert
Dessertlöffel
Cuchara postre

Cucchiaio per dessert a base di crema e salse. Molto utile anche per la prima colazione
Spoon for cream or sweet sauce desserts, very helpful for breakfast too.



07

Cucchiaino Caffè
Tea spoon
Cuillère à café
Kaffeelöffel
Cuchara café

In realtà è un cucchiaino per tè e tisane, utilizzato anche per le zuccheriere e le formaggere. Dato i molteplici utilizzi, è sempre meglio possederne una mezza dozzina in più rispetto al resto della pezzeria.
This is just a tea or herbal tea spoon, but is also used with sugar bowls and cheese basins. For this reason, it is better to have half of a dozen more than the rest of the cutlery.



08

Cucchiaino Moka
Coffee spoon
Cuillère à moka
Mokkalöffel
Cucharita moka

Cucchiaino per caffè
This is a coffee spoon



10

Cucchiandone a servire
Cooking spoon
Cuillère à legumes/ à ragût
Gemüselöffel
Cuchara legumbres

Si usa per servire sia primi piatti sia piatti principali. Buona regola possederne in quantità doppia rispetto al forchettone
It's used to serve first and main courses. It is better to have this cover twice than the cooking fork.



22

Cucchiaio Insalata
Salad serving spoon
Cuillère à salade servir
Salatvorlegelöffel
Cuchara servir ensalada

Si usa per mescolare e servire insalate, ma non solo: ottimo per servire antipasti a base di verdure e pesce. It is used to mix and serve salads, but is also very good to serve fish and vegetable hors-d'oeuvres.



23

Forchetta Insalata
Salad serving fork
Fourchette à salade servir
Salatvorlegegabel
Tenedor servir ensalada

Forchetta insalata
Si usa in coppia con
il cucchiaino insalata
Salad serving fork
It is used with the
salad spoon for serving.

25

Cucchiaino Bibita
Ice tea spoon
Cuillère à soda
Limonadenlöffel
Cucharita refresco

Cucchiaino per
cocktail e gelati
con creme in
coppe profonde
Spoon used for
cocktails and
ice-creams served
in deep drinking-glasses.

44

Cucchiaino Cappuccino
Cappuccino spoon
Cuillère à cappuccino
Cappuccinolöffel
Cucharita cappuccino

Cucchiaino per
cocktail e gelati
con creme in
coppe profonde
Spoon used for
cocktails and ice-
creams served in
deep drinking-glasses.

39

Cucchiaino Gourmet
Gourmet spoon
Cuillère à degustation
Kostprobelöffel
Cuchara degustación

Cucchiaino per dolci
e pesce con salse.
La parte schiacciata
della tazza,
consente sia di tagliare
la pietanza,
che di raccoglierne
il sugo.
It's the spoon used
for cakes and fish
with sauce. The
crushed part of the
cup , allows both to
cut the course and
to collect the juice.

45

Cucchiaino Degustazione
French sauce spoon
Cuillère à sauce individuelle
Gourmetlöffel
Cuchara salsa gourmet

Paletta per pesce
con salse, adatta a
tagliare il pezzo ed
a raccoglierne la
salsa.
Scoop for fish with
sauces , used to
cut the piece and
to reap the sauce .

35

Cucchiaino Zuppa
Soup spoon
Cuillère à soupe
Tassenlöffel rund
Cuchara para sopa

Cucchiaino per consomme,
tipica forma di cucchiaino
per minestre in
brodo della tradizione
inglese.
It's the consomme
spoon used for the
traditionals English
soups.

26

Cucchiaino americano
American coffee spoon
Cuillère pour enfant
Kinderlöffel
Cucharita bebé

Cucchiaino per il
caffè americano. il
cappuccino, la
prima colazione,
oppure per dessert
a base di creme e
salse.
Spoon used for
american coffee,
cappuccino , breakfast
or for dessert with
cream and sauces .



02

Forchetta Tavola
Table fork
Fourchette table
Tafelgabel
Tenedor de mesa

Forchetta per primi piatti e piatto principale. Dato che è il pezzo in assoluto più utile ed usato, è sempre meglio possederne in doppia quantità rispetto agli altri pezzi.
Fork for first and main courses. It's better to have this cover twice, because it is the most useful one.



05

Forchetta Frutta
Dessert fork
Fourchette à dessert
Dessertgabel
Tenedor postre

Forchetta per antipasto e per dessert a base di frutta. Utilizzata per sbaglio spesso anche per i dessert a base dolce.
Hors d'oeuvre fork used for fruit desserts, it is wrongly used for sweet desserts.



15

Forchettina Dolce
Cake fork
Fourchette à gateaux
Kuchengabel
Tenedor pastel

Forchetta per tutti i dolci e dessert, tranne quelli a base di frutta.
Fork used only for cakes and sweet desserts, but not for fruit.



27

Forchettina Bebè
Baby fork
Fourchette pour enfant
Kindergabel
Tenedor bebè

Forchetta per bambini.
Fork for babies courses.



21

Forchetta Pesce da tavola
Table fish fork
Fourchette poisson table
Fischgabel
Tenedor pescado

Forchetta per pesce e molluschi
Fork for fishes and Mollusca



11

Forchettone a servire
Serving fork
Fourchette à legumes/ à servir
Fleischgabel
Tenedor legumbres

Si usa per servire sia primi piatti sia piatti principali.
It's used to serve first and main courses



03

Coltello Tavola
Table knife
Couteau table
Tafelmesser
Cuchillo de mesa

Coltello per piatto principale. Può essere in manico cavo, come le vecchie consigli in tavola in argento, leggero ed esclusivo; oppure in manico pieno prodotto con la tecnologia della forgiatura.

Table knife: Knife for main dishes with hollow handle, light and exclusive like the old fashioned silver covers or onepiece handle, made by the forging technology.



06

Coltello Frutta
Dessert knife
Couteau à dessert
Dessertmesser
Cuchillo postre

Coltello per antipasto e per dessert in combinazione con la forchetta frutta. Per qualità vale lo stesso discorso del coltello tavola

Used with the fruit fork in the hors-d'oeuvre and the fruit desserts. It's quality is the same of the table knife.



20

Paletta Pesce da tavola
Table fish knife
Couteau poisson table
Fischmesser
Cuchillo pescado

Coltello per tagliare pesce e molluschi
Knife used to slice fishes and Mollusca



28

Coltellino Bebè
Baby knife
Couteau pour enfant
Kindermesser
Cuchillo bebé

Coltellino per bambini.
Knife for babies courses.



36

Coltello Bistecca
Steak knife
Couteau à viande
Steakmesser
Cuchillo bistek

Coltello con lama profonda per bistecche di spessore.
Sharpedged blade knife helpful to cut substantial steaks



37

Coltello per burro
Butter knife
Couteau à beurre
Buttermesser
Cuchillo para mantequilla

Coltello per burro utilizzato per la prima colazione. Nella tradizione nordica ed inglese utilizzato sulla tavola in un piatto piano da frutta accanto al posto tavola, per spalmare il burro sul pane in occasione di lunch e dinner.
Butter cover used during breakfast. In England and in the North European countries during lunch or dinner it is put in a dish near the table set to spread butter on the bread.





Must Have



BRONZO
10001128B

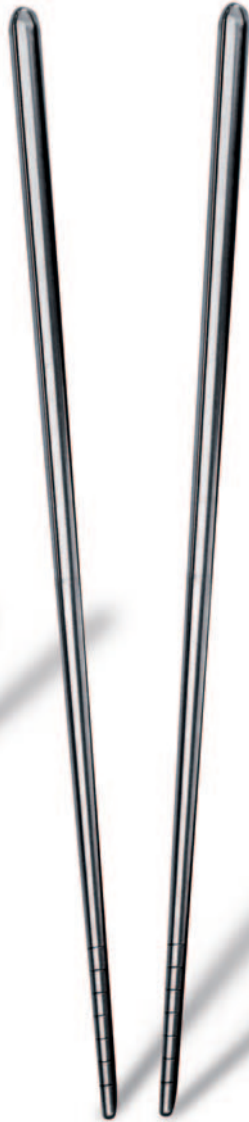

ACCIAIO
10001128



ORO NERO
10001128N



ORO
10001128O

ORO ICE
10001128OI



906
Appoggia chopstick
Chopstick rest
Porte chopstick
Ess-Stäbchen Ablage
Apoyo para chopstick

Largh. cm. 4,5
Width 1 3/4"

1128
Paia Chopsticks
Chopsticks set 2 pcs.
Paire de chopsticks
Ess-Stäbchen Paar
Chopsticks 2 pzas.

cm. 22,5
8 7/8"

CHOP STICKS





915
 Appoggia posate
 Knife rest
 Soutier p/couverts
 Besteck Ablage
 Apoyo p/cubiertos

Largh. cm. 6,5
 Width 2 1/2"



906
 Appoggia posate
 Knife rest
 Soutier p/couverts
 Besteck Ablage
 Apoyo p/cubiertos

Largh. cm. 4,5
 Width 1 3/4"



BRONZO
 10001175B



**ORO
 NERO**
 10001175ON



ACCIAIO
 10001175



ORO
 10001175O

ORO ICE
 10001175OI

1175
 Appoggia posate
 Knife rest
 Soutier p/couverts
 Besteck Ablage
 Apoyo p/cubiertos

Largh. cm. 6,5
 Width 2 1/2"

APPOGGIA POSATE



NEW

ACCIAIO

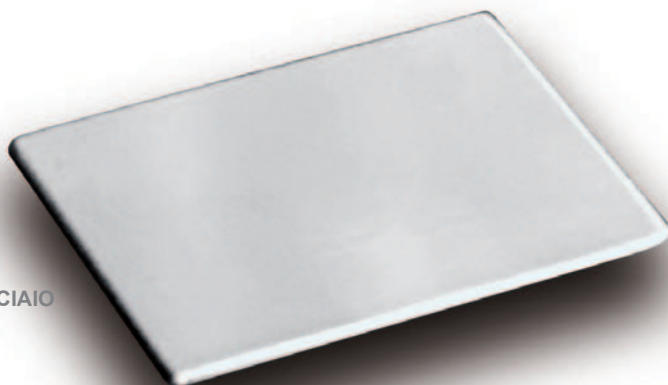

ORO



ORO ICE



BRONZO

339
Appoggia posate
Knife rest
Soutier p/couverts
Besteck Ablage
Apoyo p/cubiertos

Largh. cm. 6,5
Width 2 1/2"



ORO
NERO

APPOGGIA POSATE



421

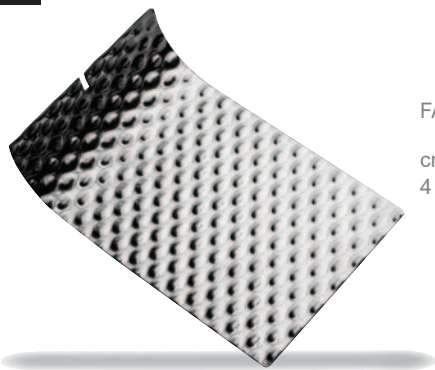

FASHION

cm. 12 x 8
4 3/4" x 3 1/7"

423

FASHION

cm. 11 x 3
4 1/3" x 1 1/5"

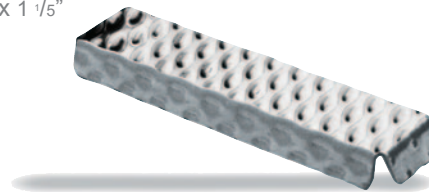

920



cm. 10 x 8
4" x 3 1/7"

424

GIOTTO

cm. 11 x 3
4 1/3" x 1 1/5"



338

NEW



cm. 10 x 7
4" x 2 3/4"

Appoggia posate
Knife rest
Soutier p/couverts
Besteck Ablage
Apoyo p/cubiertos

APPOGGIA POSATE





BRONZO
10001144B



ACCIAIO
10001144



ORO
NERO
10001144ON



ORO
10001144O
ORO ICE
10001144OI

1144
Coltello bistecca americano
American steak knife
Couteau entrecôte américain
Amerikanisches Steakmesser
Cuchillo bistek americano
cm. 25
9 5/8"

BISTECCA AMERICANO





UNI
10001136

Coltello bistecca
Steak knife
Couteau entrecôte
Steakmesser
Cuchillo bistek
cm. 21,3
8 1/4"

NORMA
10101136
BOHEME
10231136

Coltello bistecca
Steak knife
Couteau entrecôte
Steakmesser
Cuchillo bistek
cm. 23
9 1/8"

ROMA
10141136
1020B1136

NATURA
10341136
Coltello bistecca
Steak knife
Couteau entrecôte
Steakmesser
Cuchillo bistek
cm. 22,7
8 7/8"

10701136
CARINZIA

Coltello bistecca
Steak knife
Couteau entrecôte
Steakmesser
Cuchillo bistek
cm. 23,1
9 1/9"

10711136
STOCCOLMA

Coltello bistecca
Steak knife
Couteau entrecôte
Steakmesser
Cuchillo bistek
cm. 23,1
9 1/9"

BISTECCA





THE GOOD DESIGN AWARDS 2016

As Awarded by The Chicago Athenaeum:
Museum of Architecture and Design



Ci sono Chef nel mondo che emozionano attraverso il gusto. Uno di questi è Ferran Adrià, cui omaggiamo l'idea della Quarta Posata, ispirata dalla sua pinza per tapas, oggi cambiata e migliorata per usi nuovi a tavola, insieme ai JRE Italia.

Cucchiaio, Forchetta, Coltello, Quarta Posata. Da oggi possiamo divertirci di più a tavola!



There are Chefs in the world who continuously create emotions through taste and do it better than us. One of these chefs is Ferran Adrià, who we honor with the idea of the Quarta Posata, inspired by his tapas tongs. Today, thanks to the collaboration with JRE Italy, is changed and improved for new uses on table: Spoon, Fork, Knife, Quarta Posata Starting today, we can have more fun on table!



QUARTA POSATA





10001129
Quarta posata

Lungh. cm. 22,2
Length 8 ³/₄"





10001140
Pinza aragosta
Lobster pincers
Pince à homard
Hummerzange
Pinza langostas

cm. 18,5
7 1/3"



10001139
Forchetta aragosta
Lobster fork
Curette à homard
Hummergabel
Tenedor langostas

cm. 19,4
7 2/3"

ARAGOSTA



NEW

NEW



BRONZO
10341146B



ACCIAIO
10341146



ORO
NERO
10341146ON



ORO
10341146O
ORO ICE
10341146OI

1146
Cucchiaio multifunzione
Multifunctional spoon
Cuillère multifonctionnelle
Multifunktionaler Löffel
Cuchara multifuncional

cm. 17,6
6 3/8"

MULTIFUNZIONE



NEW

NEW



BRONZO
10101130B

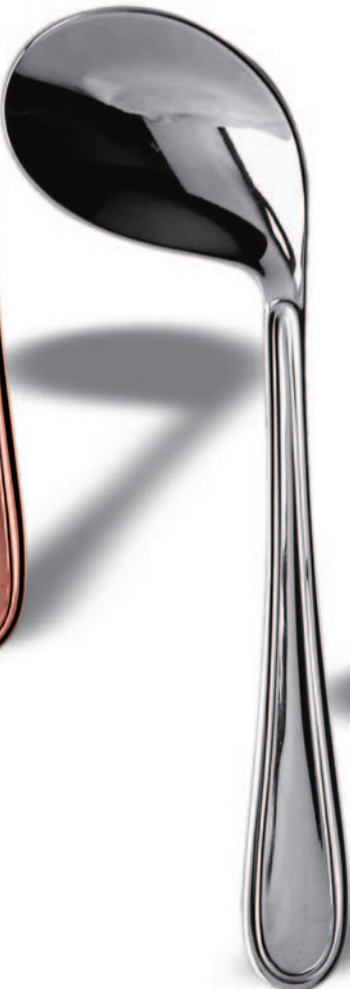

ACCIAIO
10101130



ORO
NERO
10101130ON



ORO
10101130O

ORO ICE
10101130OI

1130
Amuse-bouche spoon

cm. 14,5
5 3/4"

AMUSE-BOUCHE



NEW

NEW



BRONZO
10001133B



ORO
NERO
10001133ON

ACCIAIO
10001133



ORO
10001133O
ORO ICE
10001133OI

1133
Cucchiaio per miele
Honey spoon
Cuillère à miel
Honiglöffel
Cuchara de miel

cm. 16
6 1/4"

MIELE





BRONZO
200727B



ORO
NERO
200727ON



ACCIAIO
200727



ORO
200727O

ORO ICE
200727OI

727
Coppa per intermezzo
Intermezzo cup
Coupe à intermezzo
Sorbetschale
Copa para intermezzo

cl. 4
oz. 1 ³/₈

INTERMEZZO

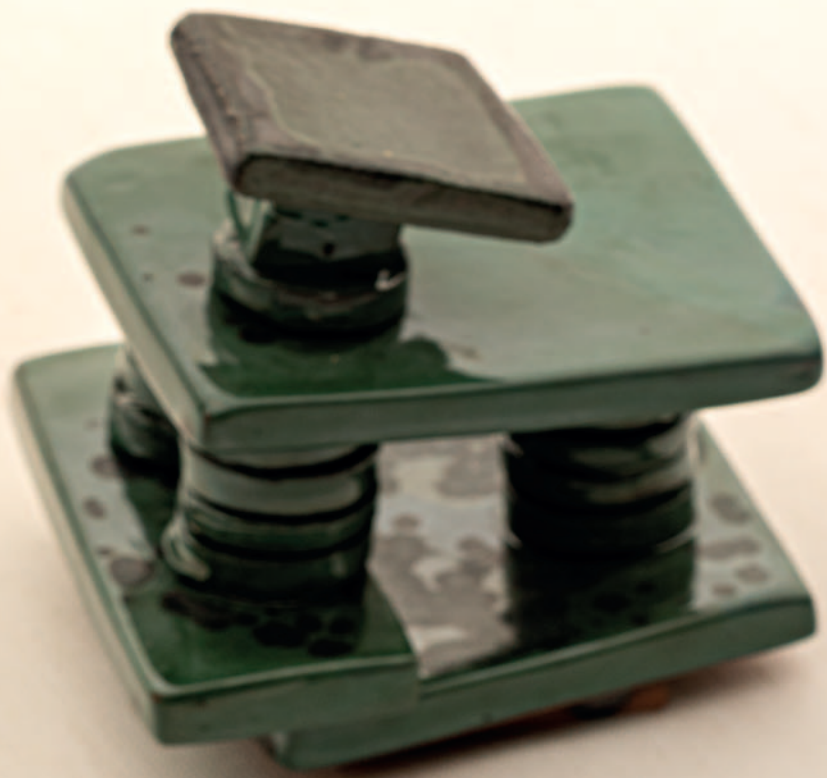

NEW

421

FASHION
Appoggia posate
Knife rest
Soutier p/couverts
Besteck Ablage
Apoyo p/cubiertos

cm. 12 x 8
4 3/4" x 3 1/7"

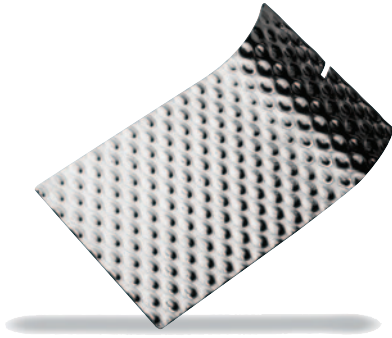

NEW

423

FASHION
Appoggia posate
Knife rest
Soutier p/couverts
Besteck Ablage
Apoyo p/cubiertos

cm. 11 x 3
4 1/3" x 1 1/5"



920

Appoggia posate
Knife rest
Soutier p/couverts
Besteck Ablage
Apoyo p/cubiertos

cm. 10 x 8
4" x 3 1/7"



NEW

424

GIOTTO
Appoggia posate
Knife rest
Soutier p/couverts
Besteck Ablage
Apoyo p/cubiertos

cm. 11 x 3
4 1/3" x 1 1/5"



740

Coppetta amouse bouche
Appetizer bowl
Bol multi-usages
Fingerfood-/Vorspeisen-/Butter-Gefäss
Cuenco para finger food/amouse bouche

cm. 13 x 7 - cl. 4
5 1/9" x 2 3/4" - oz. 4



10521131

Mini Forchetta
Appetizer fork
Fourchette amouse bouche
Minigabel
Mini tenedor

cm. 11,4
4 1/2"



10521108
Mini spoon

cm. 11,4
4 1/2"



750

Micro forchetta
Micro fork
Micro fourchette
Mikrogabel
Micro tenedor





ARAGOSTE

ANTIPASTI



10001140
Pinza aragosta
Lobster pincers
Pince à homard
Hummerzange
Pinzalangostas
cm. 18,5
7 1/3"



10001139
Forchetta aragosta
Lobster fork
Fourchette langouste
Hummergabel
Tenedor langostas
cm. 19,4
7 2/3"



1020B1143
Cucchiaio risotto
"Risotto" spoon
Cuillère "Risotto"
Reislöffel
Cuchara arroz seco
cm. 27,7
11"



10201144
Cucchiaino cappuccino
Cappuccino spoon
Cuillère cappuccino
Cappucinolöffel
Cucharita cappuccino
cm. 16,5
6 1/2"



10001150
Golf club mixer spoon
Golf club mixer spoon
Golf crosse pour cocktail
Golf Schleger für Long drink
Golf club cucharita por coctél
cm. 16,5
6 1/2"

Modelli-Models
POSATE

LUMACHE

FORMAGGIO



779
Molla lumache
Escargot tongs
Pince escargots
Schneckenzange
Pinzas caracoles
cm. 15,6
6 1/4"



10001138
Forchetta lumache
Escargot fork
Fourchette escargots
Schnecken-gabel
Tenedor caracoles
cm. 14,9
5 7/8"



10001147
Forchetta formaggio
Cheese fork
Fourchette fromage
Käsegabel
Tenedor queso
cm. 21
8 3/8"



10001125
Coltello formaggio
Cheese knife
Couteau fromage
Kaesemesser
Cuchillo queso
cm. 22
8 3/4"



10001126
Coltello parmigiano
Parmesan chesse knife
Couteau parmesan
Parmesanmesser
Cuchillo parmigiano
cm. 16,5
6 1/2"



10001109



cm. 22
8 5/8"

mm. 3,0

Mestolo
Ladle
Louche
Suppschöpfer
Cazo sopa

mm. 3,0



cm. 18,5
7 1/4"

10001116

Pala per torta
Cake trowel
Pelle à tarte
Tortenheber
Pala tarta

10001142



cm. 20,7
8 1/8"

mm. 3,0

Cucchiaione
da risotto
Spoon for "Risotto"
Cuillère à "Risotti"
Reislöffel
Cuchara para arroz seco

mm. 2,5



cm. 10,5
4 1/4"

10001115

Forchettina dolce
Cake fork
Fourchette à gateaux
Kuchengabel
Tenedor pastel

10001110



cm. 17,5
6 3/4"

mm. 3,0

Cucchiaione
Serving spoon
Cuillère à servir
Servierlöffel
Cuchara servir

mm. 3,0



cm. 15,5
6"

10001120

Paletta pesce tavola
Table fish knife
Couteau poisson
Fischmesser
Pala pescado

10001111



cm. 17
6 5/8"

mm. 3,0

Forchettone
Serving fork
Fourchette à servir
Serviergabel
Tenedor servir

mm. 3,0



cm. 15,5
6"

10001121

Forchetta pesce tavola
Table fish fork
Fourchette poisson
Fischgabel
Tenedor pescado

10001122



cm. 17
6 5/8"

mm. 3,0

Cucchiaio insalata
Salad serving spoon
Cuillère à salade
Salatvorlegelöffel
Cuchara para ensalada

mm. 3,0



cm. 12,5
4 7/8"

Happy spoon

10001141

10001123



cm. 17
6 5/8"

mm. 3,0

Forchetta insalata
Salad serving fork
Fourchette à salade
Salatvorlegegabel
Tenedor para ensalada

mm. 2,5



cm. 8,5
3 3/8"

10001127

Cucchiaino bibita
Ice tea spoon
Cuillère à soda
Limonadenlöffel
Cucharita refresco

10001124

Paletta gelato
Ice-cream spoon
Cuillère à glâce
Eislöffel
Cucharita helado

HAPPY



Fantasia



● Non ci si stanca mai del colore, soprattutto in ciò che ci circonda. Fantasia è un apostrofo funky tra le parole "Eleganza" e "Raffinatezza" di tutte le nostre collezioni. le posate sono realizzate in acciaio inossidabile 18/10 e da coloratissimi manici ad alta resistenza (hanno la stessa resistenza del legno, ma si possono lavare in lavastoviglie migliaia di volte).

● You never get tired of the color, especially in our surroundings. Fantasy is a funky apostrophe between the words "Elegance" and "Refinement" of all our collections. the cutlery are made of 18/10 stainless steel and highly coloured handles with high resistance (it has the same resistance of the wood, but it can be washed in the dishwasher thousands of times).

Fantasia è:

- Ultraresistente
- Lavabile in lavastoviglie
- Saldata ad ultrasuoni per una tenuta perfetta
- Acciaio inossidabile 18/10 ad elevato spessore
- Garantita a vita
- Ideale per:
- Pool & Pathio
- Spiaggie
- Urban & Pop
- Ospedali
- Case di residenza per anziani
- Yacht
- Chalet
- Giardini
- Loft

Fantasia is:

- Ultra-resistant
- Dishwasher safe
- Ultrasonic welded for a perfect seal
- High thickness 18/10 Stainless steel
- Lifetime guaranteed
- Ideale for:
- Pool & Pathio
- Beaches
- Urban & Pop
- Hospitals
- Retirement homes
- Yacht
- Chalet
- Rooftop Gardens
- Loft





Mirror



O

ON

B

C

A

AR

Oro
Lucido

Oro Nero
Lucido

Bronzo
Lucido

Champagne
Lucido

Arcobaleno
Lucido

Argentato
Lucido



Ice



OI

ION

IB

IC

IA

ARI

Oro
Ice

Oro Nero
Ice

Bronzo
Ice

Champagne
Ice

Arcobaleno
Ice

Argentato
Ice



Peltro



PO

Oro
Peltro

PON

Oro Nero
Peltro

PB

Bronzo
Peltro

PC

Champagne
Peltro

PA

Arcobaleno
Peltro

PAR

Argentato
Peltro

COLORI DISPONIBILI



N
Nero
Black



I
Vigogna
Vicuna



W
Porcellana
China



M
Tabacco
Tobacco



S
Salvia
Sage



T
Tortora
Turte-dove



L
Vaniglia
Vanilla



D
Sesamo
Sesame



B7
Ciclamino
Light mauve



H7
Lilla
Lilac



P7
Rosa
Pink



Z7
Rosa pallido
Pale Rose



V
Verde
Green



A7
Mela verde
Apple Green



E
Verde acido
Acid Green



Q7
Verde oliva
Olive Green

AVAILABLE COLORS

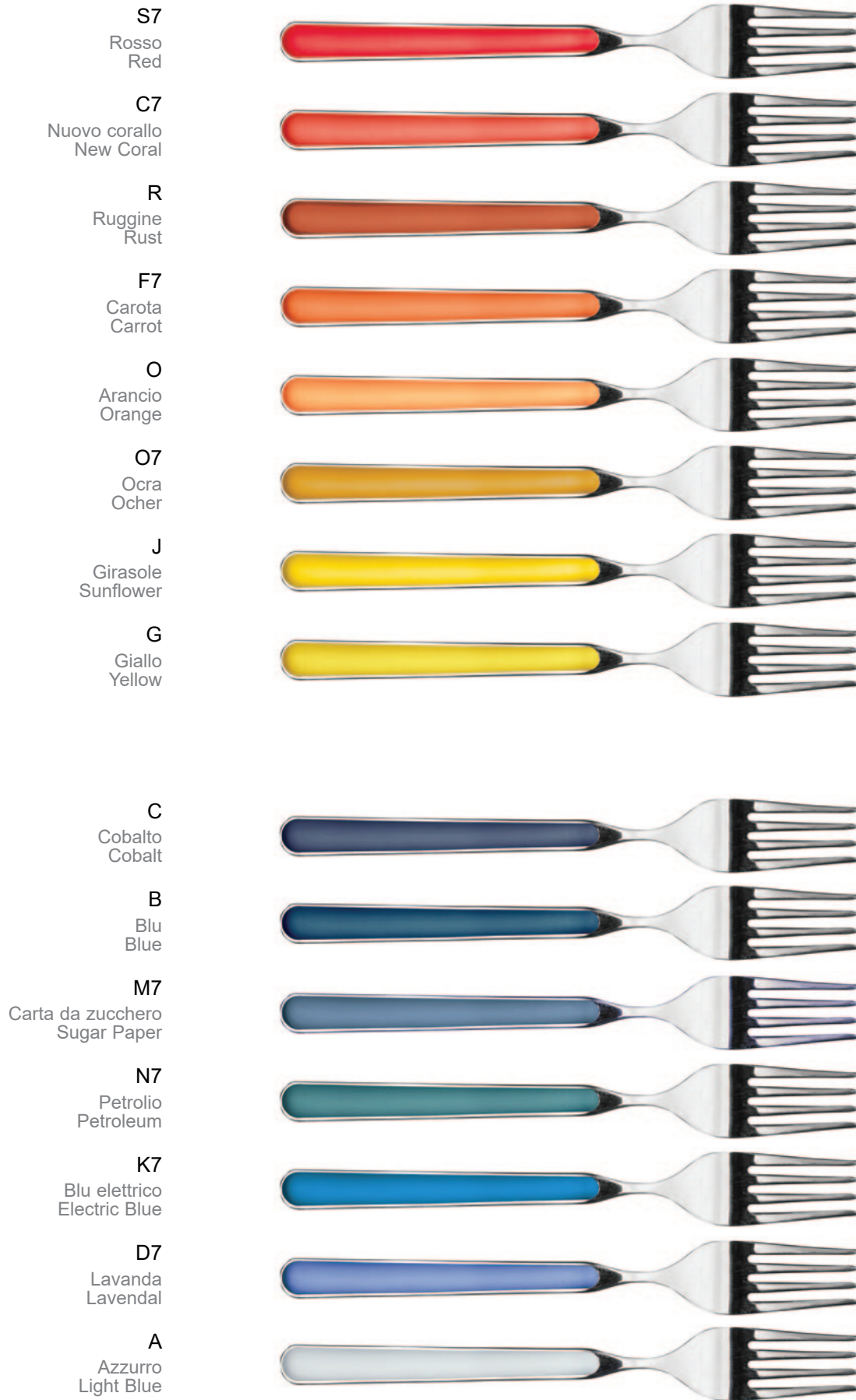

PEZZI DISPONIBILI

10(color)1101

Cucchiaio tavola
Table spoon



Lunghezza 197 mm
Length 7 3/4"

10(color)1102

Forchetta tavola
Table fork



Lunghezza 197 mm
Length 7 3/4"

10(color)1103

Coltello tavola
Table knife



Lunghezza 223 mm
Length 8 3/4"

10(color)1104

Cucchiaio frutta
Dessert spoon



Lunghezza 174 mm
Length 6 7/8"

10(color)1105

Forchetta frutta
Dessert fork



Lunghezza 175 mm
Length 6 8/9"

10(color)1106

Coltello frutta
Dessert knife



Lunghezza 197 mm
Length 7 3/4"

10(color)1107

Cucchiaino caffè
Tea spoon



Lunghezza 133 mm
Length 5 1/4"

10(color)1115

Forchettina dolce
Cake fork



Lunghezza 157 mm
Length 6 1/5"

10(color)1126

Cucchiaino caffè americano
American size coffee spoon



Lunghezza 156 mm
Length 6 1/7"

10(color)1116

Pala per torta
Cake trowel



Lunghezza 254 mm
Length 10"

AVAILABLE RANGE

10(color)1122

Cucchiaio insalata a servire
Salad serving spoon



Lunghezza 233 mm
Length 9 1/6"

10(color)1123

Forchetta insalata a servire
Salad serving fork



Lunghezza 233 mm
Length 9 1/6"

10(color)1110

Cucchiaione
Serving spoon



Lunghezza 235 mm
Length 9 1/4"

10(color)1111

Forchettone
Carving fork



Lunghezza 235 mm
Length 9 1/4"

10(color)1140

Mestolino per salsiera
Gravy ladle



Lunghezza 185 mm
Length 7 1/4"

10(color)1120

Paletta pesce da tavola
Table fish knife



Lunghezza 198 mm
Length 7 4/5"

10(color)1121

Forchetta pesce da tavola
Table fish fork



Lunghezza 195 mm
Length 7 2/3"

10(color)1143

Cucchiaone da risotto
Rice spoon



Lunghezza 277 mm
Length 10 8/9"

10(color)1142

Forchetta per fonduta
Fondue fork



Lunghezza 290 mm
Length 11 2/5"

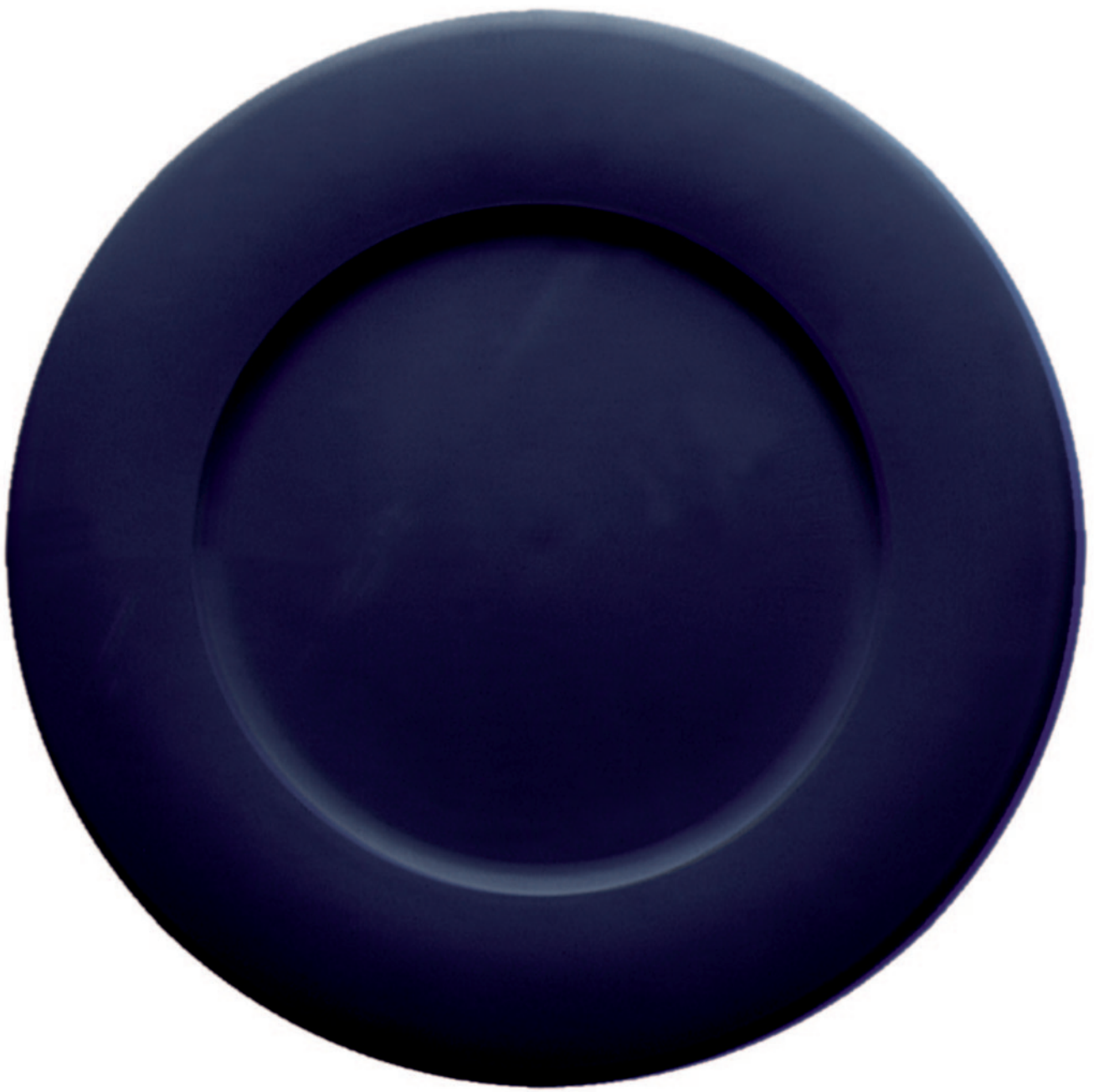

25(color)135

Sottopiatto
Charger

Ø 32 cm
Length 12 5/8"



Vasellame



HOLLOWARE
MATERIEL DE SERVICE
ACCESSOIRES
ORFEBRERIA

- Gamma completa per tutti gli usi
- Spessore elevato
- Doppia saldatura manici, alta resistenza
- Beccucci rompigoccia
- Prodotti impilabili salvaspazio
- Criterio di progettazione di ogni prodotto accuratamente studiato per il quotidiano uso nel settore alberghiero.
- Each collection offers an extensive range of different items.
- Thicker stainless steel.
- Double welded handles offer durability.
- Drip-less spouts on all pitchers, creamers, coffee and tea pots.
- Space saving stackable items.
- Hospitality grade and professional quality

MEPRA
S.p.A.

- Gamme complète pour tous les us
- Épaisseur massives
- Soudures manches haute résistance
- Becs rompigoutes
- Articles empilables pour sauver space
- Critère de projet de chaque produit est étudié pour l'usage quotidien soigneusement dans le secteur hôtelier

- Ein vollständiges Sortiment für jeden Gebrauch
- Hohe Materialstärke
- Doppelt geschweisste
- Handgriffe, hohe Widerstandsfähigkeit
- Kein Tropfen beim Ausgießen
- Stapelbar und platzsparend
- Jedes Produkt ist genauens für den täglichen
- Gebrauch in der Spitzengastronomie und -hotellerie gestaltet

- Gamma completa para todos los usos.
- Espesor macizo
- Mango soldado de alta resistencia.
- Vertedor rompe gotas
- Producto apilable ahorra espacio
- Criterio de diseño de cada producto estudiado minuciosamente para el uso cotidiano en el sector hostelero.





Carbon Fiber



14270

ANNIE

Vassoio in carbonio

Carbon fiber tray

Plateau en fibre de carbone

Kohlefaser-Tablett

Bandeja de fibra de carbono

cm. 72 x 50

28 1/3" x 19 3/4"





Black Gold



930

NEW



mm. 1,2 PALACE
Parure per caviale
Caviar Parure
Parure pour caviar
Kaviar Parure
Parure para caviar

Ø cm. 40 Ø 15³/₄"
cl. 105 oz. 35 1/2

734

NEW



mm. 1,2 GIOTTO
Parure per caviale
Caviar Parure
Parure pour caviar
Kaviar Parure
Parure para caviar

Ø cm. 40 Ø 15³/₄"
cl. 105 oz. 35 1/2

735

NEW



mm. 1,2 Cofanetto per caviale da 500 grammi
Caviar box 500 grams
Coffret de caviar 500 grammes
Kaviar-Box 500 g
Caja de caviar de 500 gramos

Ø cm 14 Ø 5 1/2"
Lt. 0,5 oz. 16 7/8



BRONZO
10001199B

ORO
NERO
10001199ON

CHAMPAGNE
10001199C

10001199
Cucchiaino per caviale
Caviar spoon
Cuillère à caviar
Kaviarlöffel
Cucharita para caviar

Lungh. cm. 12
Length 4 ³/₄"

ORO
10001199O

ORO ICE
10001199OI

CAVIALE



712



mm. 1,2 Chillcup per burro e caviale con base
Chillcup for butter and caviar with base
Chillcup pour beurre et caviar avec socle
Chillcup für Butter und Kaviar mit Fuß
Chillcup para mantequilla y caviar con pedestal

714



Servizio per caviale
Caviar set
Service à caviar complet
Kaviarschale
Servicio para caviar

Ø cm. 18
cl. 15
Ø 7 1/8"
oz. 5 1/8

713



Chillcup per burro
Chillcup for butter
Chillcup pour beurre
Chillcup für Butter
Chillcup para mantequilla

Ø cm. 12
cl. 15
Ø 4 3/4"
oz. 5 1/8

721



mm. 1,2 Coppa termica con cloche
Insulated cup with cloche
Coupe thermique avec cloche
Isolier-Eisfruchtbecher mit Deckel
Copa térmica con tapa

Ø cm. 8,5 Ø 3 1/3"
cl. 15 oz. 6

922



PALACE
Mini burriera con coperchio
Small butter dish w/lid
Petit beurrier a/couvercle
Mini Butterdose m/Deckel
mm. 1,2

cm. 12 x 6
cl. 15

4 3/4" x 2
1/3"
oz. 5 1/8

975



Chillcup
Caviar dish
Bol à caviar
Chillcup / Kaviarschale
Bol para caviar
mm. 1,2

Ø cm 19
cl. 15

Ø 7 1/2"
oz. 5 1/8

702



GIOTTO
Mini burriera con coperchio
Small butter dish w/lid
Petit beurrier a/couvercle
Mini Butterdose m/Deckel
Platillo para mantequilla con tapa
mm. 1,2

cm. 12 x 6
cl. 15

4 3/4" x 2
1/3"
oz. 5 1/8





Atmosfera

ATMOSFERA

La collezione ATMOSFERA è realizzata in acciaio inossidabile 18/10 con un trattamento di verniciatura in polvere. Oltre alla collezione ATMOSFERA, possiamo realizzare tutto il vasellame di questo catalogo nei tre colori:

The ATMOSFERA collection is made of 18/10 stainless steel with a powder coating treatment. In addition to the collection ATMOSFERA, we can make all the tableware of this catalog in the three colors:

La collection ATMOSFERA est réalisée en acier inoxydable 18/10 avec un traitement de revêtement en poudre. En plus de la collection ATMOSFERA, nous pouvons faire toute la vaisselle de ce catalogue dans les trois couleurs:

Die ATMOSFERA Kollektion besteht aus 18/10 Rostfrei von pulverförmig. Zusätzlich der Kollektion ATMOSFERA, können wir dieses Katalog in den drei Farben machen:

La colección ATMOSFERA está hecha de acero inoxidable 18/10 con un tratamiento de recubrimiento en polvo. Además de la colección ATMOSFERA, podemos realizar toda la orfebrería de este catálogo en los tres colores:



O
Materic Gold



N
Vulcan Grey



B
Materic Bronze

1016



mm. 1,2

MERCURIO
Cestino
Basket
Corbeille
Früchtekorb
Cesta

Ø cm. 11 Ø 4 3/8"
H cm. 12,5 H 4 7/8"
cl. 55 oz. 18 5/8

1017



mm. 1,2

Ø cm. 19 Ø 7 1/2"
H cm. 20 H 7 3/4"
Lt. 2,5 oz. 84 1/2

Ø cm. 29 Ø 7 1/2"
H cm. 18,5 H 7 3/4"
Lt. 8 oz. 84 1/2

669MG



mm. 1,2

Cestino
Basket
Corbeille
Früchtekorb
Cesta

Ø cm 14
H cm 13,5
lt. 0,70

Ø 5 2/3"
H 5 1/8"
oz. 23 2/3

668MG



mm. 1,2

Secchiello per spumante
Sparkling wine cooler
Seau à champagne
Wein- und Sektkühler
Cubo para champany

Ø cm 24
H cm 23
lt. 2,75

Ø 9 1/2"
H 9"
oz. 93

666FMG



mm. 1,2

Colonna portasecchiello
Wine cooler stand
Pied pour seau à champagne
Weinkühlerständer
Columna porta cubo champany

H cm. 65 H 25 5/8"



1011



1014



1013



1012



mm. 1,2

GIOVE
Cestino
Basket
Corbeille
Früchtekorb
Cesta

1011

cm. 16,6 x 10
H cm. 14,2
cl. 180
6 1/2" X 4"
H 5 3/5"
oz. 60 7/8

1014

cm. 27 x 20,5
H cm. 21,5
Lt. 6,5
10 5/8" X 8"
H 8 1/2"
gal. 1 3/4

mm. 1,2

MARTE
Cestino
Basket
Corbeille
Früchtekorb
Cesta

1013

Ø cm. 29
H cm. 18,5
Lt. 8
Ø 11 3/8"
H 7 1/4"
gal. 2

1012

Ø cm. 16,8
H cm. 11
cl. 150
Ø 6 5/8"
H 4 3/8"
oz. 50 3/4

666HMG



666CMG



mm. 1,2

Colonna portasecchiello spumante
Wine cooler stand
Pied pour seau à champagne
Weinkühlerständer
Columna porta cubo champany

H cm. 61,5

H 24 1/5"

mm. 1,2

Colonna portasecchiello spumante
Wine cooler stand
Pied pour seau à champagne
Weinkühlerständer
Columna porta cubo champany

H cm. 67,5

H 26 5/8"

1009



mm. 1,2

VENERE
Cestino
Basket
Corbeille
Früchtekorb
Cesta

cm. 22 x 20
H cm. 11,5
Lt. 1,2

8 5/8" x 7 7/8"
H 4 5/8"
oz. 40 1/2

1010



mm. 1,2

VENERE
Cestino
Basket
Corbeille
Früchtekorb
Cesta

cm. 39 x 36
H cm. 17,5
Lt. 7

15 3/8" x 14 1/4"
H 7"
gal. 1 4/5



1001



mm. 1,2

SATURNO
Piano
Tray
Plateau
Tablett oval
Bandeja

cm. 40 x 36 15 3/4" x 14 1/8"

mm. 1,2

1006



SATURNO
Piano
Tray
Plateau
Tablett oval
Bandeja

cm. 22 x 20 8 5/8" x 7 7/8"

1003



mm. 1,2

SATURNO
Piano
Tray
Plateau
Tablett oval
Bandeja

cm. 34 x 31 13 3/8" x 12 1/4"

mm. 1,2

1004



SATURNO
Piano
Tray
Plateau
Tablett oval
Bandeja

cm. 14 x 12 5 1/2" x 4 3/4"

1002



mm. 1,2

NETTUNO
Cestino
Basket
Corbeille
Früchtekorb
Cesta

100222
cm. 22 x 20
cl. 100

100222
8 5/8" x 7 7/8"
OZ. 33 7/8

100240
cm. 40 x 36
cl. 200

100240
15 3/4" x 14 1/8"
OZ. 67 5/8

mm. 1,2

PLUTONE
Allacciatovaglioli
Napkins ring
Rond de serviette
Serviettenring
Servilletero

Ø cm. 6

Ø 2 3/8"

1005

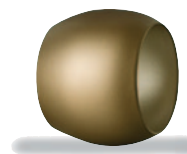



Sushic



787

787



TRE
Vassoio per prima colazione
Breakfast tray
Plateau rect. pour le petit déjeuner
Frühstück Tablett, rechteckig
Bandeja rect. por desayuno

cm. 50 x 32 27 1/2" x 12 5/8"

791AC

NEW

163



NEW

155



Inserto Finger Food per vassoio quadro e rettangolare
Finger Food insert for square and rectangular tray
Insért Finger Food pour plateau carré et rectangulaire
Finger Food-Einsatz für quadratische/rechteckig Schale
Inserto para Finger Food por bandeja cuadrada y rectangular
mm. 1,2

cm. 30 x 30

11 7/8" x 11 7/8"

Porta noccioli
Olive seeds jar
Porte noyaux
Aderhalter
Porta granos
mm. 1,2

Ø cm. 6
H cm. 5
cl. 5

Ø 2 2/5"
H 2"
oz. 1 3/4

TRE
Set per aperitivi
Appetizer set
Set pour Amouse bouche
Vorspeisen Set
Set para aperitivos

cm. 22 x 22
cl. 30

8 5/8" x 8 5/8"
oz. 10 1/8

793



TRE
Completo oliera con spargisale
Cruet and salt cellar set
Huile-vinaigre 4 pcs
Essig-/Öl-Menage 4-Tlg.
Vinagreras con saleros

cm. 15 x 15 6" x 6"
H cm. 19,6 H 7 3/4"
cl. 30 (x2) oz. 10 1/8 (x2)
cl. 8 (x2) oz. 2 3/4 (x2)

TRE
Formaggera
Parmesan cheese basin
Fromagère
Käsedose
Quesera Azucarero

cm. 15 x 15 6" x 6"
cl. 20 oz. 6 3/4



794

792



TRE
Vassoio rettangolare
Rectangular tray
Plateau rectangulaire
Tablett, rechteckig
Bandeja rectangular

cm. 50 x 32 19 3/4" X 12 3/4"
cm. 30 x 20 11 3/4" X 7 7/8"

788



QUATTRO
Vassoio rettangolare
Rectangular tray
Plateau rectangulaire
Tablett, rechteckig
Bandeja rectangular

cm. 50 x 32 19 3/4" X 12 3/4"
cm. 30 x 20 11 3/4" X 7 7/8"

791



TRE
Vassoio/Sottopiatto
Square Tray/Charger
Plateau/Assiette de bienvenue
Tablett/Platzteller,
Bandeja/Bajo plato

cm. 32 x 32 12 3/4" x 12 3/4"

789



QUATTRO
Vassoio/Sottopiatto
Square Tray/Charger
Plateau/Assiette de bienvenue
Tablett/Platzteller,
Bandeja/Bajo plato

cm. 32 x 32 12 3/4" x 12 3/4"

795



TRE
Tovaglietta americana
Place mat
Set de table
americain en bois
Tischset aus Holz
individual en madera

cm. 38 x 28 15" x 11"

796



TRE
Sottopiatto
Charger
Assiette de bienvenue
Platzteller
Bajo plato

Ø cm. 33 Ø 13"

804



TRE
Portacondimenti
Basket for aromatic condiments
Corbeille pour aromatiques condiments
Tisch-Essig/Öl-Flaschenhalter
Cesto para aromaticos y condimentos

cm. 15 x 15 6" x 6"
H cm. 19,6 H 7 3/4"

797



TRE
Cestino quadrato
Square basket
Corbeille carré
Schale, eckig
Panera cuadrada

cm. 15 x 15 6" x 6"
cm. 20 x 20 7 7/8" x 7 7/8"

599

58928

7 colori disponibili - pag. 312 - 313
7 colors available - pages 312 - 313
7 couleurs disponibles - pag. 312 - 313
7 verschiedenen Farben verfügbar - Seiten 312 - 313
7 colores disponibles - pag. 312 - 313

589 - Ø cm. 28
Ø 11"



mm. 1,2 UNO
Cestino traforato
Fretworked basket
Corbeille, ajourée
Früchtekorb gelocht
Cesta perforada

Ø cm. 29 Ø 11 3/8"
H cm. 18,5 H 7 1/4"
lt. 8 gal. 2

666B

Disponibile in color
Available in walnut
Disponible en couleur
In Wengè und Walnuss
Disponible en color



noce e wengè
and wengè color
noyer et wengè
Farbe verfügbar
nuez y wengè

TRE
Colonna portasecchiello
Wine cooler stand
Pied pour seau à champagne
Weinkühlerständer
Columna porta cubo champany

H cm. 65 H 25 5/8"



A Noce
Walnut
Noyer
Walnuss
Nuez

R Rovere
Oak
Chêne
Eiche
Roble

W Wengé





232



mm. 1,2 Vassoio da Sushi
Sushi tray
Plateau pour Sushi
SushiTablett
Bandeja por Sushi

cm. 40 x 30 15 3/4" x 11 7/8"

526



mm. 1,2 Vassoio rettangolare a 4 comp.
Rectangular tray 4 comp.
Plateau rectangulaire 4 plac.
Tablett, rechteckig 4 Eins.
Bandeja rectangular 4 posic.

cm. 23 x 13 9" x 5 1/8"

720



Porta zenzero e Wasabi
Ginger and wasabi tray
Porte-gingembre et Wasabi
Ingwerdose und Wasabi
Porta jengibre y wasabi

cm. 17,5 x 7,5 6 7/8" x 3"

155



Ø cm. 6
H cm. 5
cl. 5

Ø 2 2/5"
H 2"
oz. 1 3/4

544

Ø cm 9
Ø 3 1/2"

10001129

Quarta posata
mm. 2,5
Lungh. cm. 22,2
Length 8 3/4"

10001128

Chop sticks
Lungh. cm. 22,5
Length 8 7/8"

10001128

10001129

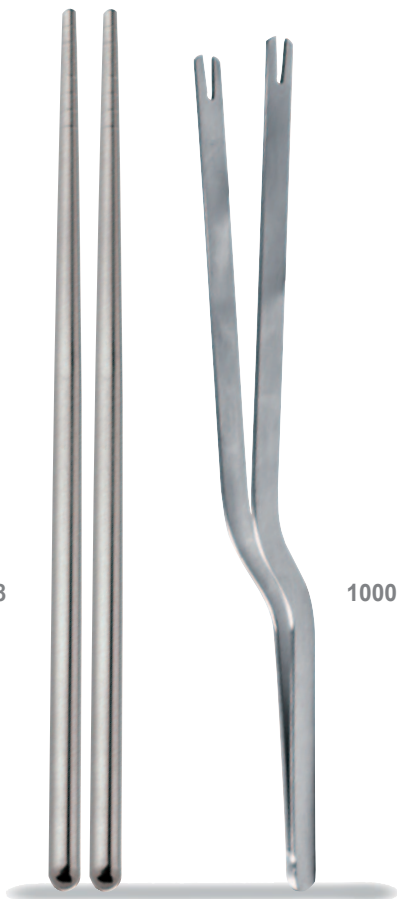

906



Appoggia Chopstick
Chopsticks rest
Soutier p/chop sticks
Chop Sticks Ablage
Apoyo p/Chop sticks

Largh. cm. 4,5 Width 1 3/4"



3504

3404

S7



S7



BARCELONA

J



J



Ø cm. 12,5

Ø 5"

cm. 14 x 14

5 1/2" x 5 1/2"

3503

3403

F7



F7



AMSTERDAM

N7



N7



Ø cm. 12,5

Ø 5"

cm. 14 x 14

5 1/2" x 5 1/2"

3505

3405

H7



H7



BERLIN

Q7



Q7

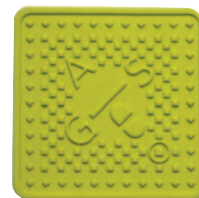

Ø cm. 12,5

Ø 5"

cm. 14 x 14

5 1/2" x 5 1/2"



3200

S7



3100
3600

S7



ROMA

S7

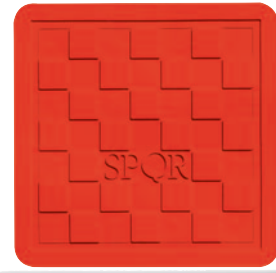

3300

J

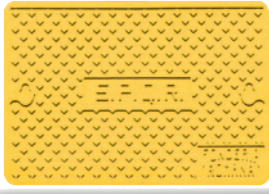

cm. 30 x 45

11 3/4" x 17 3/4"

3100
3600

J



3100
3600

Ø cm. 17 Ø 6 3/4"
Ø cm. 35 Ø 13 7/8"

J

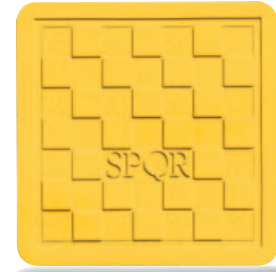

cm. 45 x 45

17 3/4" x 17 3/4"

3202

F7



3102
3602

F7



LONDON

F7



3302

N7



3102
3602

Ø cm. 17 Ø 6 3/4"
Ø cm. 35 Ø 13 7/8"

N7



cm. 45 x 45

17 3/4" x 17 3/4"

3201

H7



3101
3601

H7



PARIS

H7



3301

Q7



cm. 30 x 45

11 3/4" x 17 3/4"

3101
3601

Q7



3101
3601

Ø cm. 17 Ø 6 3/4"
Ø cm. 35 Ø 13 7/8"

Q7



cm. 45 x 45

17 3/4" x 17 3/4"



845



mm. 1,2	Portaghiaccio termico con coperchio	H cm 13	H 5"
	Insulated ice-bucket with lid	Ø cm 14	Ø 5 1/2"
	Seau à glaçons thermique avec couvercle	cl.72	oz. 24 1/3
	Thermo Eiseimer mit Deckel	H cm 22	H 8 5/8"
Cubitera hielo con tapa		Ø cm 24	Ø 9 1/2"
		lt. 4,0	gal. 1

843



856

mm. 1,2	Secchiello per spumante	H cm 13	H 5"
	Sparkling wine cooler	Ø cm 14	Ø 5 1/2"
	Seau à champagne	cl.125	oz. 42 1/4
	Wein- und Sektkühler	H cm 22	H 8 5/8"
Cubo para champany		Ø cm 24	Ø 9 1/2"
		lt. 4,0	gal. 1

666G

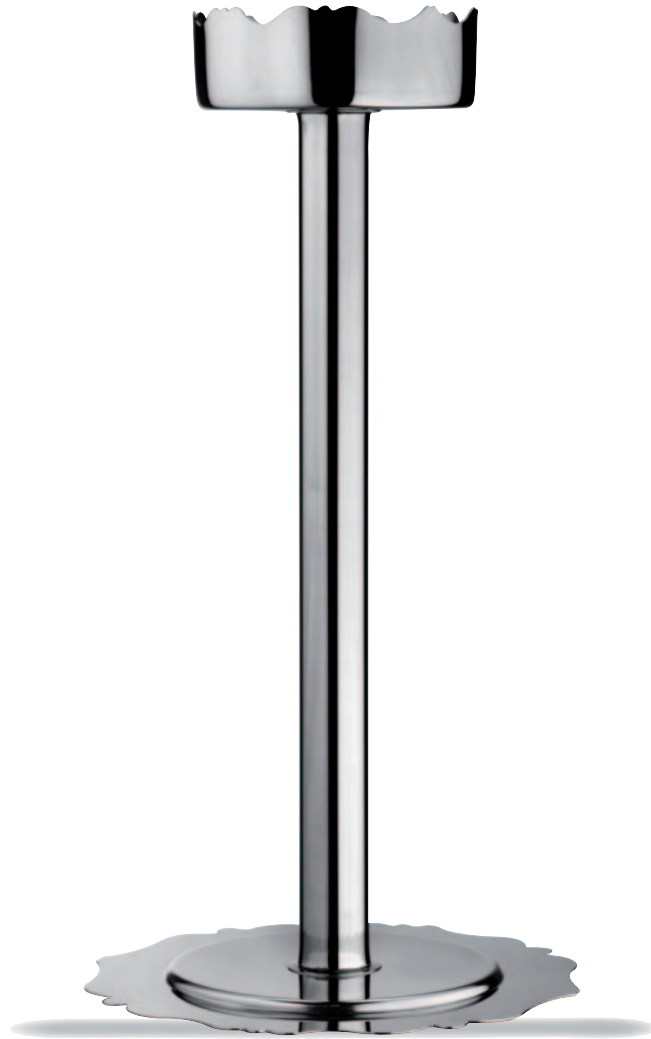

mm. 1,2	Colonna portasecchiello spumante	H cm. 62	H 24 3/8"
	Wine cooler stand		
	Pied pour seau à champagne		
	Weinkühlerständer		
Columna porta cubo champany			

800



mm. 1,2 Vassoio rettangolare c/interno ovale
 Rectangular tray, w/oval int.part
 Plateau rectangulaire a/partie interne ovale
 Tablett rechteckig mit ovaler Innenform
 Bandeja rectangular con la parte interna ovalada

cm. 47x34 18¹/₂" x 13³/₈"
 cm. 56x40 22" x 15³/₄"

808

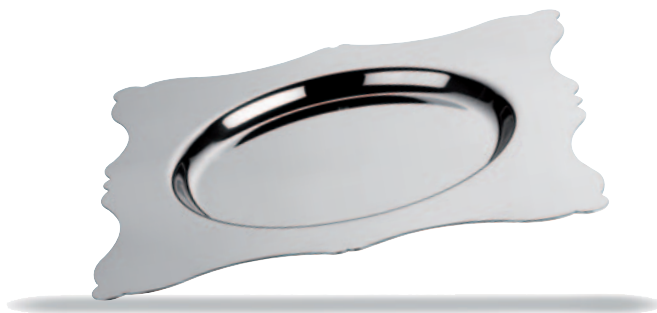

mm. 1,2 Vassoio quadro con interno tondo
 Square tray, w/round internal part
 Plateau carré a/partie interne ronde
 Tablett quadratisch mit runder Innenform
 Bandeja cuadrada c/la parte interna redonda

cm. 40x40 15³/₄" x 15³/₄"

801



mm. 1,2 Vassoio rettangolare c/int.ovale c/piedini
 Rect.tray, w/oval int.part and feet
 Plateau rect.a/partie ovale int. sur pied
 Tablett rechteckig mit ovaler Innenform und Füßen
 Bandeja rect.c/parte int.oval.y pies

cm. 47x34 18¹/₂" x 13³/₈"
 cm. 56x40 22" x 15³/₄"

809



mm. 1,2 Vassoio quadro c/int.tondo c/piedini
 Square tray, w/round int.part w/feet
 Plat.carré a/partie int.ronde s/pied.
 Tablett quadratisch mit runder Innenform und Füßen
 Band.cuad.c/parte int.red.y 3 pies

cm. 40x40 15³/₄" x 15³/₄"

802



mm. 1,2 Vassoio rett.c/int.ovale e pied.
 Rect.tray, w/oval int.part w/base
 Plateau rect.a/par.int. ovale s/socle
 Tablett rechteckig mit ovaler Innenform und Fuss
 Bandeja rect.c/parte int.oval. y pedestal

H cm. 14 H 5 1/2"
 cm. 47x34 18¹/₂" x 13³/₈"
 cm. 56x40 22" x 15³/₄"

807



mm. 1,2 Vassoio quadro c/int.tondo c/pied.
 Square tray, w/round int.part w/base
 Plat.carré a/partie int.ronde e/socle
 Tablett quadratisch mit runder Innenform und Fuss
 Band.cuad.c/parte int.red.y pedest.

H cm. 18 H 7"
 cm. 40x40 15 3/4" x 15 3/4"

805



mm. 1,2 Vassoio rettangolare
Rectangular Tray
Plateau rectangulaire
Tablett rechteckig
Bandeja rectangular
cm. 48 x 36 18⁷/₈" x 14¹/₈"

861



mm. 1,2 Vassoio portalettere/portaconto
Tray for correspondence, for bill
Plateau à main
Tablett für Korrespondenz oder
Rechnungen
Bandeja para la correspondencia o
facturas
cm. 26 x 22 10" x 8 1/2"

806



mm. 1,2 Vassoio rett.c/int.rett.con piedini
Rect.tray, w/rect.int.part and feet
Plateau rect.a/partie int.rect.s/pied
Tablett rechteckig mit Füßen
Bandeja rect.c/parte int.rect.c/4 pies
cm. 26x22 10" x 8 1/2"
cm. 48x36 18⁷/₈" x 14¹/₈"

862



mm. 1,2 Vassoio portalettere, portaconto
con piedini
Tray for correspondence, for bill w/feet
Plateau à main sur pieds
Tablett für Korrespondenz oder
Rechnungen mit Füßen
Bandeja para la correspondencia
o facturas con 4 pies
cm. 26 x 22 10" x 8 1/2"

810



mm. 1,2 Vassoio rett.c/int.rett.con piedist.
Rect.tray, w/rect.int.part and base
Plateau rect.a/partie int.rect.s/socle
Tablett rechteckig mit Fuss
Bandeja rect.c/parte int.rect.c/ped.
H cm. 14 H 5 1/2"
cm. 26x22 10 x 8 1/2"
cm. 48x36 18⁷/₈" x 14¹/₄"

863

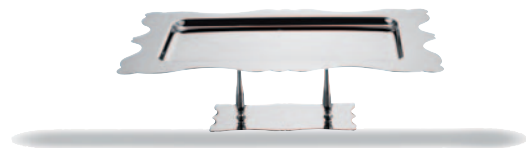

mm. 1,2 Vassoio portalettere, portaconto con piedistallo
Tray for correspondence, for bill w/feet
Plateau pour la correspondance ou factures
sur socle
Tablett für Korrespondenz oder Rechnungen m/Fuss
Bandeja para la correspondencia o facturas c/ped.
H 13,5 H 5 3/8"
26 x 22 10" x 8 1/2"

860



mm. 1,2 Cestino rotondo
Round bowl
Bol rond/Corbeille
Schale, rund
Cuenco redondo

Ø cm. 18 Ø 7 1/8"

858



mm. 1,2 Ciotola finger food/amouse/bouche/burro
Finger food/amouse bouche/butter bowl
Bol multi-usages
Fingerfood-/Vorspeisen-/Butter-Gefäß
Cuenco para finger food/amouse
bouche/mantequilla

Ø cm. 8,5 Ø 3 3/8"

826



mm. 1,2 Cestino
Basket
Corbeille
Schale
Cuenco

cm. 13 x 13 5 1/8" x 5 1/8"
cm. 16 x 16 6 3/8" x 6 3/8"
cm. 32 x 32 12 5/8" x 12 5/8"

828



mm. 1,2 Centrotavola
Centerpiece
Centre de table
Tafelaufsatz
Centro de mesa

H cm. 7 H 2 7/8"
cm. 27 x 27 10 5/8" x 10 5/8"
cm. 37 x 37 14 5/8" x 14 5/8"

827



mm. 1,2 Cestino con piedistallo
Basket with base
Corbeille sur socle
Obstkorb auf Fuss
Cesta con pedestal

H cm. 19,5 H 7 5/8"
cm. 13 x 13 5 1/8" x 5 1/8"

H cm. 23 H 9"
cm. 16 x 16 6 3/8" x 6 3/8"

H cm. 26,5 H 10 1/2"
cm. 32 x 32 12 5/8" x 12 5/8"



840



mm. 1,2 | Portabustine/biglietti da visita
Sugar packet/business card holder
Porte cartes/sachets
Zuckerbeutel- Visitenkartenhalter
Azucarera/Porta tarjetas comerciales

cm. 10 x 7 4 1/8" x 2 7/8"

830



mm. 1,2 | Svuoatasche
Square basket
Corbeille carrée
Schale, eckig
Cuenco cuadrado

cm. 15 x 15 5 7/8" x 5 7/8"
cm. 22 x 22 8 5/8" x 8 5/8"

848



mm. 1,2 | Porta pasticcini
Petit-fours stand
Porte-petits fours
Kuchen/Gebäckplatte auf Fuß
Porta dulces

H cm. 9,5 H 3 3/4"
Ø cm. 14 Ø 5 1/2"

H cm. 14 H 5 1/2"
Ø cm. 21 Ø 8 1/4"

826



842



mm. 1,2 | Porta pasticcini a 2 piani
Petit-fours stand 2 layers
Porte-petit fours 2 étages
Kuchen/Gebäckplatte 2-stufig
Porta dulces 2 pisos

H cm 25,5 H 10"
Ø cm 14-21 Ø 5 1/8" - 8 1/4"



mm. 1,2 | Alzata portafrutta rettangolare 2p.
Rectangular fruit holder 2 layers
Serveur rectangulaire 2 étages
Etagere, rechteckig 2-stufig
Frutero rectangular 2 pisos

H cm. 44 H 17 3/8"
cm. 47 x 34 18 1/2" x 13 3/8"
cm. 56 x 40 22" x 15 3/4"

813

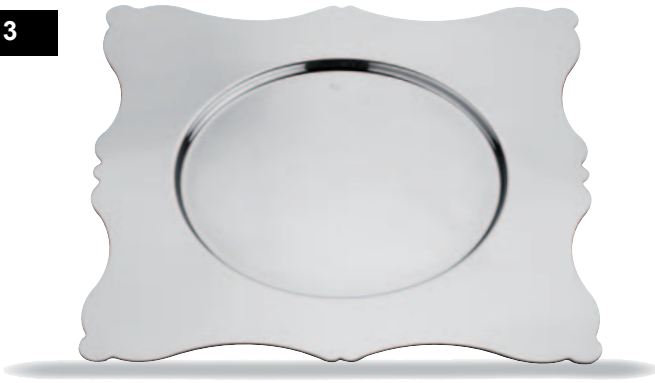

mm. 1,2 Sottopiatto quadro
Square charger
Assiette de bienvenue carrée
Platzteller, viereckig
Bajo plato cuadrado

cm. 32 x 32 12 5/8" x 12 5/8"



838



mm. 1,2 Sottobicchiere
Glass coaster
Dessous de verre
Glasuntersatz
Posavasos

cm. 10 x 10 4" x 4"

839



mm. 1,2 Sottobottiglia
Bottle coaster
Dessous de bouteille
Flaschenuntersatz
Posabotella

cm. 14 x 14 5 1/2" x 5 1/2"

833

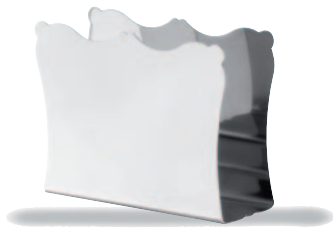

mm. 1,0 Portatovaglioli
Napkin holder
Distributeur de serviettes
Serviettenhalter
Portaservilletas

H cm. 9 H 3 1/2"
cm. 12,5 x 4 5" x 1 5/8"

846



mm. 1,0 Vasetto portafiori
Flower vase
Soliflore
Blumenvase
Florero

H cm. 14 H 5 1/2"

81601

81602



mm. 3,0 Allacciatovaglioli
Napkins ring
Rond de serviettes
Serviettenring
Servilletero

Ø cm. 9 Ø 3 1/2"

mm. 3,0 Allacciatovaglioli
Napkins ring
Rond de serviettes
Serviettenring
Servilletero

Ø cm. 9 Ø 3 1/2"

81603

81604



mm. 3,0 Allacciatovaglioli
Napkins ring
Rond de serviettes
Serviettenring
Servilletero

cm. 9 x 8 3 1/2" x 3 1/7"

mm. 3,0 Allacciatovaglioli
Napkins ring
Rond de serviettes
Serviettenring
Servilletero

cm. 8 x 8 3 1/7" x 3 1/7"

81605

81606



mm. 3,0 Allacciatovaglioli
Napkins ring
Rond de serviettes
Serviettenring
Servilletero

cm. 8 x 8 3 1/7" x 3 1/7"

mm. 3,0 Allacciatovaglioli
Napkins ring
Rond de serviettes
Serviettenring
Servilletero

cm. 10 x 7 4" x 2 5/8"

812



mm. 1,2 Formaggera
Parmesan cheese basin
Fromagère
Parmesan Menage
Quesera Azucarero

Ø cm. 14
cl. 20

Ø 5 1/2"
oz. 6 3/4

811



mm. 1,2 Completo oliera con spargisale
Cruet and salt cellar set
Service huile-vinaigre 4pcs.
Menage 4-Tlg.
Convoy vinagreras con saleros
4 pzas.

H cm. 19,6
Ø cm. 21
cl. 76

H 7 3/4"
Ø 8 1/4"
oz. 25 3/4

85402



mm. 1,2 Portachiavi
Key holder
Porte-clés
Schlüsselanhänger
Portallaves

cm. 8 x 8

3 1/8" x 3 1/8"

852



mm. 1,2 Vassoio rotondo
Round tray
Plateau rond
Tablett rund
Bandeja redonda

Ø cm. 21

Ø 8 1/4"

836



mm. 1,2 Portabicchieri di carta
Paper cup holder
Porte-gobelets de papier
Papier- und Becherständer
Portavasos de papel

H cm. 22,5
cm. 23 x 12,5

H 8 7/8"
8 7/8" x 4 7/8"

831



mm. 1,2 Portacondimenti con astina
Basket for aromatic condiments
Support pour Condiments et
Aromates
Ständer für Essig und Öl
Cestos para aromaticos y
condimentos

H cm. 33
cm. 15 x 15

H 13"
5 7/8" x 5 7/8"

835



mm. 3,0 Portapiatti di plastica cm. 22 x 22 8 5/8" x 8 5/8"
 Plastic paper plate dispenser
 Porte assiettes
 Papptellerspender
 Portaplatos de plastica

832



mm. 3,0 Portarotolo H cm. 29 H 11 2/5"
 Paper towel holder cm. 15 x 15 5 7/8" x 5 7/8"
 Porte rouleau de papier
 Papierrollenhalter
 Portarollos de papel

7063



Candelabro a 3 fiamme H cm. 23,6
 Candelabra, 3 arms
 Chandelier 3 flammes H 9 1/4"
 Kerzenständer für 3
 Kerzen
 Candelabro 3 luces

85303



mm. 3,0 Segnaposto H cm. 8 H 3 1/8"
 Table number stand cm. 8 x 8 3 1/8" x 3 1/8"
 Marqueur de table
 Tischnummern-Ständer
 Numero de mesa

Original Vintage





Gli articoli di queste pagine, sono già disponibili in magazzino nella versione antichizzata, PELTRO. Tutti gli altri articoli possono essere forniti in versione PELTRO, a richiesta, senza quantità minima

The items on these pages are already available in stock in the antiqued PELTRO version. All the other items can be supplied on request in the PELTRO version, without minimum quantity.

Les articles des cetttes pages sont déjà disponible en stock dans la version avec la surface vieillie, PELTRO. Tous les autres articles peuvent être fournis en version PELTRO, sur demande, sans quantité minimum.

Die Artikeln auf diese Seiten sind Ausführungen in der antiken, Oberfläche PELTRO auf Lager bereits. Alle anderen Artikeln können auf Anfrage ohne Mindestmenge in der PELTRO-Version geliefert werden

Los artículos de estas páginas son ya disponibles en el almacén en la versión PELTRO, con la superficie envejecida. Todos los otros artículos se pueden suministrar en la versión PELTRO, bajo pedido, sin cantidad mínima.

187

186



Portauovo
Egg-cup
Coquetier
Eierbecher
Huevera
mm. 1,2

cm. 15 x 9
5 7/8" x 3 1/2"



Mini burriera
Mini Butter dish
Mini Beurrier
Mini Butterdose mit
Deckel
Mini Mantequera
mm. 1,2

cm. 12 x 6
cl. 15
4 3/4" x 2"
oz. 6

184



Salsiera
Gravy boat
Saucière
Sauciere
Salsera
mm. 1,2

cl. 30
oz. 10 1/8

178



Saucière
cl. 4
oz. 1 3/8
mm. 1,2

173

177



Piatto ovale da portata pesce
bordo rinforzato
Oval serving fish plate
with reinforced edges
Plat à poisson oval bord renforcé
Fischplatte, oval
Fuente pescado borde reforzado
mm. 1,2

cm. 55 x 24
cm. 70 x 29
21 5/8" x 9 1/2"
27 1/2" x 11 3/8"

172



Piatto ovale da portata
bordo rinforzato
Oval serving plate
with reinforced edges
Plat oval bord renforcé
Bratenplatte, oval
Fuente ovalada borde reforzado
mm. 1,2

cm. 30 x 21
cm. 40 x 27
cm. 50 x 35
11 3/4" x 8 1/4"
15 3/4" x 10 5/8"
27 1/2" x 11 3/8"

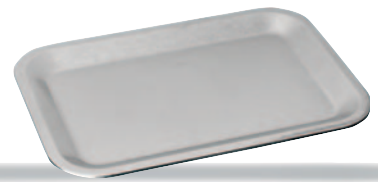

Vassoio rettangolare per
pasticceria
Rectangular tray for cakes
Plat à tarte rectangulaire
Gebäckplatte, rechteckig
Bandeja
mm. 0,6

cm. 26 x 19
cm. 31 x 21
10 1/4" x 7 1/2"
12 1/4" x 8 1/4"

182

174



Vassoio per gratin
Tray for "gratin"
Plat à "gratin"
Gratinplatte
Bandeja gratinar
mm. 1,2

cm. 35 x 20
cm. 40 x 24
13 3/4" x 7 1/8"
15 3/4" x 9 1/2"

181



Vassoio per gratin e gastronomia
Tray for "Gratin-gastronomy"
Plat à "Gratin et gastronomie"
Gratinplatte für Gastronomie
Bandeja para gratinar y gastronomia
mm. 1,2

cm. 30 x 22
cm. 40 x 29
11 3/4" x 8 5/8"
15 3/4" x 11 3/8"



Piatto rotondo da portata
bordo rinforzato
Round serving plate
with reinforced edges
Plat rond de service bord
renforcé
Bratenplatte, rund
Bandeja redonda borde
reforzado
mm. 1,2

Ø cm. 27
Ø cm. 35
Ø cm. 40
Ø 10 5/8"
Ø 13 3/4"
Ø 15 3/4"



171

170



880



Cestino semitraforato
Half fretworked basket
Corbeille demi-ajouré
Schale, halbgelocht
Frutero semiperforado

Ø cm. 22
H cm. 5,7
cl. 150

Ø 8 5/8"
H 2 1/4"
oz. 50 1/4

Scodella lavadita
Finger bowl
Ecuelle
Fingerbowl
Lavadedos

Ø cm. 12
cl. 30

Ø 4 3/4"
oz. 10 1/8

Cestino traforato
Fretworked basket
Corbeille ajouré
Schale, gelocht
Frutero perforado

Ø cm. 22
H cm. 5,7
cl. 150

Ø 8 5/8"
H 2 1/4"
oz. 50 1/4

mm. 0,8

mm. 0,6

mm. 0,8

175

874



176



Piatto tondo per legumi a 3 scompi.
3 sections vegetable dish
Plat à légumes rond - 3 compt.
Teller rund 3 Abteilungen
Bandeja para legumbres 3 comp.

Ø cm. 27
Ø 10 5/8"

Piatto ovale per legumi a 2 scompi.
2 section vegetable dish
Plat à légumes oval - 2 comp.
Teller oval, 2 Abteilungen
Bandeja para legumbres 2 comp.

cm. 30 x 21
11 3/4" x 8 1/4"

Sottopiatto
Charger
Assiette de bienvenue
Platzteller
Bajo plato

Ø cm. 33
Ø 13"

mm. 0,8

mm. 0,8

mm. 1,2

185

884



882



Ciotola con base
Bowl with base
Bol avec socle
Obstschale auf Fuss
Cuenco con pedestal
mm. 1,2

Ø cm. 14 - cl. 60
H cm. 8,8
Ø cm. 20 - lt. 1,8
H cm. 11
Ø cm. 24 - lt. 3,1
H cm. 14

Ø 5 1/2" - oz. 20 1/2
H 3 1/2"
Ø 7 7/8" - oz. 60 7/8
H 4 1/2"
Ø 11" - oz. 104 7/8
H 6 1/3"

Secchio per ghiaccio
Ice bucket with grill
Seau à glaçons
Eisgefäß
Cubitera hielo
mm. 1,2

Ø cm. 14
H.cm.13
cl. 150
Ø 5 1/2"
H 5 1/8"
oz. 50 3/4

Secchio per spumante
Sparkling wine cooler
Seau à champagne
Wein-und Sektkühler
Cubo para champany
mm. 1,2

Ø cm.23
H cm.22,5
lt. 8,5
Ø 9"
H 8 7/8"
gal. 2 1/4

188

180

881

179



Tegamino friggiuova
Frying pan for eggs
Plat à oeuf
Eierpfanne
Plato huevos

Ø cm. 16

Ø 6 1/4"

mm. 0,8

Coppa per gelato
Ice-cream bowl
Coupe à glace
Eisschale
Copa helado

Ø cm. 8,5
cl. 15

Ø 3 1/3"
oz. 5

mm. 0,6

Molla per arrosto e verdure
Roasts and vegetables tongs
Pince à salade et à rôti
Servierzange
Pinzas asado y verduras

cm. 21

8 1/4"

mm. 0,8

Molla per spaghetti
Spaghetti/Pasta tongs
Pince à spaghetti
Spaghettizange
Pinzas spaghetti

cm. 21

8 1/4"

mm. 0,6

87504

87508



mm. 1,2

Bricco
Jug
Cruche
Milchkanne
Jarra

Tazze 4
Cups
Bols
Tassen
Tazas

cl. 40

13 1/2 oz.

Bricco
Jug
Cruche
Milchkanne
Jarra

Tazze 8
Cups
Bols
Tassen
Tazas

cl. 70

23 5/8 oz.

87802

87908



mm. 1,2

Bricco
Jug
Cruche
Milchkanne
Jarra

Tazze 2
Cups
Bols
Tassen
Tazas

cl. 25

8 1/2 oz.

Zuccheriera
Sugar bowl
Sucrier
Zuckerdose
Azucarero

Tazze 8
Cups
Bols
Tassen
Tazas

cl. 30

10 1/8 oz.



Tendence

609



mm. 1,2
Piano
Tray
Plateau
Tablett oval
Bandeja

cm. 40 x 36 15 3/4" x 14 1/8"

612



mm. 1,2
Piano forato
Tray fretworked handles
Plateau avec anses ajourée
Grifftablett oval
Bandeja asa perforada

cm. 40 x 36 15 3/4" x 14 1/8"

613



mm. 1,2
Fondo
Bowl
Bol
Brotschale oval
Cuenco

cm. 22 x 20 8 5/8" x 7 7/8"
cl. 80 oz. 27

cm. 40 x 36 15 3/4" x 14 1/8"
lt. 4,0 gal. 1

614



mm. 1,2
Fondo forato
Bowl fretworked handles
Bol avec anses ajourée
Griffschale oval
Cuenco asa perforada

cm. 22 x 20 8 5/8" x 7 7/8"
cl. 49 oz. 16 1/2

cm. 40 x 36 15 3/4" x 14 1/8"
lt. 2,6 oz. 87 7/8

617



mm. 1,2
Sottopiatto ovale
Charger oval
Assiette de bienvenue ovale
Platzteller oval
Bajo plato oval

cm. 34 x 31 13 3/8" x 12 1/4"
cm. 39 x 36 15 3/8" x 14 1/8"

616AC



mm. 1,2
Piatino per pane
Bread tray
Plat pour pan
Brot Platte
Plato para pan

cm. 14 x 12 5 1/2" x 4 3/4"

561



mm. 1,2 Rettangolare piano
Rectangular tray
Plateau rectangulaire
Tablett, rechteckig
Bandeja rectangular

cm. 23 x 13 9" x 5 1/8"
cm. 38 x 25 15" x 9 7/8"

562



mm. 1,2 Rettangolare fondo
Rectangular bowl
Bol rectangulaire
Obstschale, rechteckig
Cuenco rectangular

cm. 38 x 25 15" x 9 7/8"
H cm. 5,1 H 2"
cl. 300 oz. 101 1/2

557



mm. 1,2 Ovale piano
Oval tray
Plateau, oval
Tablett, oval
Bandeja oval

cm. 37 x 25 14 1/2" x 9 7/8"
cm. 46 x 31 18 1/8" x 12 1/4"

558



mm. 1,2 Ovale fondo
Oval bowl
Bol oval
Obstschale, oval
Cuenco oval

cm. 37 x 25 14 1/2" x 9 7/8"
H cm. 6,3 H 2 1/2"
cl. 250 oz 84 1/2
cm. 46 x 31 18 1/8" x 12 1/4"
H cm. 6,3 H 2 1/2"
cl. 400 gal. 1

563



mm. 1,2 Quadro piano
Square tray
Plateau carré
Tablett, quadratisch
Bandeja cuadrada

cm. 15 x 15 5 7/8" x 5 7/8"
cm. 22 x 22 8 5/8" x 8 5/8"

564



mm. 1,2 Quadro fondo
Square bowl
Bol carré
Schale, quadratisch
Cuenco cuadrado

cm. 15 x 15 5 7/8" x 5 7/8"
H cm. 4,9 H 2"
cl. 50 oz. 16 7/8
cm. 22 x 22 8 5/8" x 8 5/8"
H cm. 4,9 H 2"
cl. 150 oz. 50 3/4

559



mm. 1,2 Tondo piano Ø cm. 12 Ø 4 3/4 "
 Wine bottle coaster
 Plateau ronde
 Tablett rund
 Bandeja redonda

560



mm. 1,2 Tondo fondo Ø cm. 12 cl. 26 Ø 4 3/4" oz. 8 3/4
 Round bowl H cm. 3,9 H 1 1/2"
 Bol ronde Ø cm. 15 cl. 60 Ø 5 7/8" oz. 20 1/4
 Obstschale, rund H cm. 5 H 2"
 Cuenco redondo Ø cm. 22 cl. 131 Ø 8 5/8" oz. 44 1/3
 H cm. 5,8 H 2 1/4"
 Ø cm. 32 lt. 3,0 Ø 12 5/8" oz. 10 1 2/5
 H cm. 6,8 H 2 2/3"

568

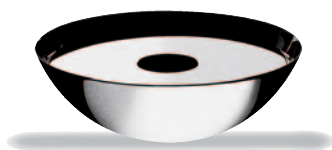

mm. 1,2 Posacenere ad acqua Ø cm. 12 Ø 4 3/4 "
 Water ashtray cl. 26 oz 8 4/5
 Cendrier à eau
 Wasseraschen rund
 Cenicerero ad agua

569



mm. 1,2 Posacenere ad acqua cm. 15 x 15 5 7/8" x 5 7/8"
 Water ashtray cl. 50 oz 16 7/8
 Cendrier à eau
 Wasseraschen quadrat.
 Cenicerero ad agua

567



mm. 1,2 Sottopiatto cm. 32 x 32 12 5/8" x 12 5/8"
 Charger
 Assiette de bienvenue
 Platzteller
 Bajo plato

870

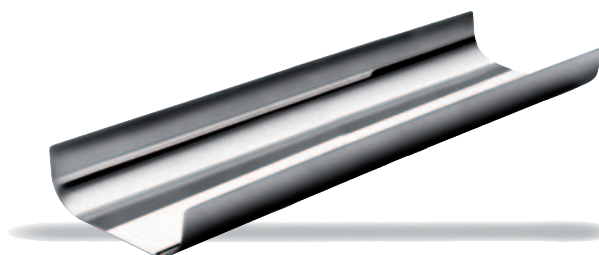

mm. 1,2 GIOTTO cm. 35,5 x 11 14" x 4 1/3"
 Portapanè / Portagrissini
 Bread / Bread sticks holder
 Porte pan / Porte gressini
 Brot und-Grissini -Schale
 Portapan / Porta bastoncillos de pan

596

599



608

mm. 1,2 Cestini traforati
Fretworked baskets
Corbeilles, ajourées
Früchtekorb gelocht
Cestas perforadas

596
Ø cm. 16,8 Ø 6 5/8"
H cm. 11 H 4 3/8"
cl. 150 oz. 50 3/4

608
Ø cm. 27 Ø 10 1/2"
H cm. 13,5 H 5 1/4"
lt. 5 gal. 1 1/3

599
Ø cm. 29 Ø 11 3/8"
H cm. 18,5 H 7 1/4"
lt. 8 gal. 2

730



mm. 1,2 Spumantiera 12 bottiglie champagne
Giant champagne bucket for 12 bottles
Seau à champagne géante pour 12 bouteilles
Champagner Bowl für 12 Flaschen
Cubo de champagne gigante para 12 botellas

cm. 75 x 65 29 1/2" x 25 5/8"
H cm. 19 H 7 1/2"
lt. 15 gal. 3 7/8

438

689

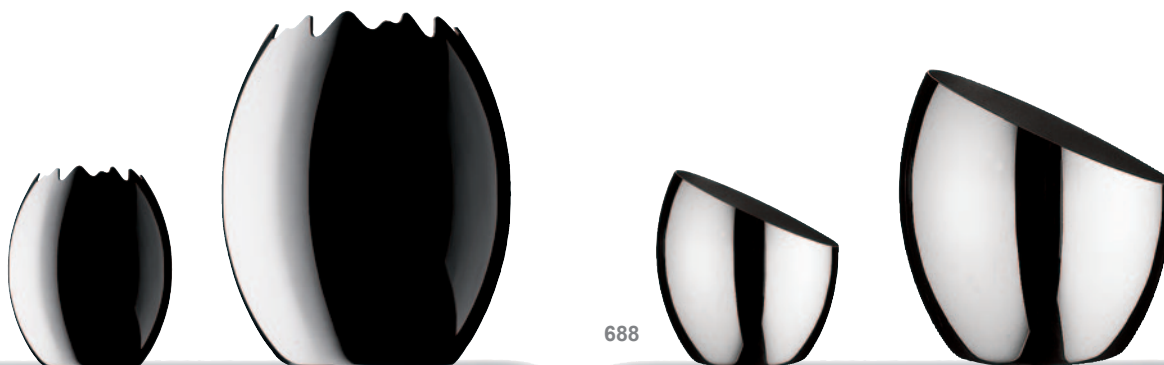

439

mm. 1,2
OVETTO
Secchiello per ghiaccio
Ice-bucket
Seau à glaçons
Eisgefäß
Cubitera hielo

Ø cm. 11
H cm. 13
cl. 100
Ø 4 3/8"
H 5 1/8"
oz. 33 7/8

mm. 1,2
OVO
Secchiello per spumante
Sparkling wine cooler
Seau à champagne
Wein- und Sektkühler
Cubo para champany

Ø cm. 19
H cm. 22
lt. 4,5
Ø 7 1/2"
H 8 5/8"
gal. 1 1/4

688

mm. 1,2
Secchiello per ghiaccio
Ice-bucket
Seau à glaçons
Eisgefäß
Cubitera hielo

Ø cm. 11
H cm. 12,5
cl. 55
Ø 4 3/8"
H 4 7/8"
oz. 18 5/8

mm. 1,2
Secchiello per spumante
Sparkling wine cooler
Seau à champagne
Wein- und Sektkühler
Cubo para champany

Ø cm. 19
H cm. 20
lt. 2,5
Ø 7 1/2"
H 7 3/4"
oz. 84 1/2

598



598
 Ø cm. 29 Ø 11 3/8"
 H cm. 18,5 H 7 1/4"
 lt. 8 gal. 2

mm. 1,2 Cestini
 Baskets
 Corbeilles
 Fruchtekorben
 Cestas

607



607
 Ø cm. 27 Ø 10 1/2"
 H cm. 13,5 H 5 1/4"
 lt. 5 gal. 1 1/3



597
 Ø cm. 16,8 Ø 6 5/8"
 H cm. 11 H 4 3/8"
 cl. 150 oz. 50 3/4

597

666C

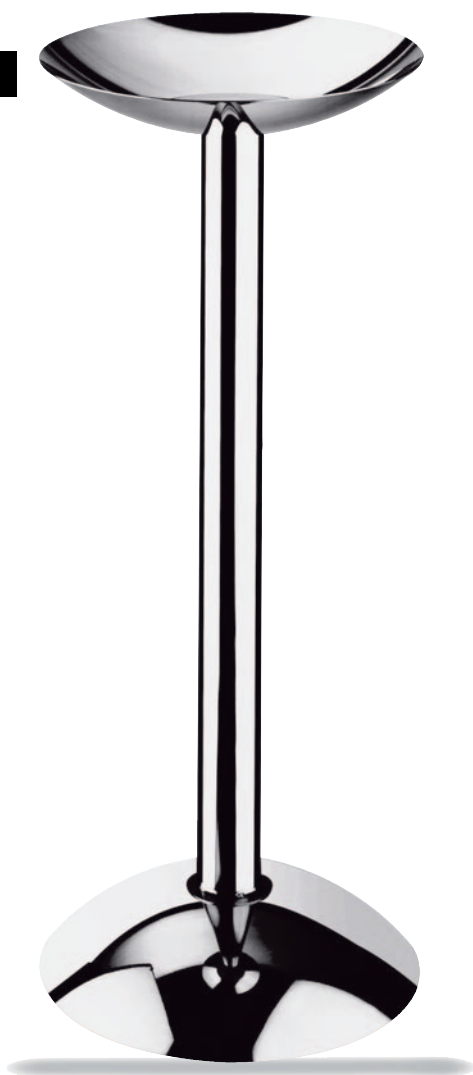

mm. 1,2 UNO
 Colonna portasecchiello spumante
 Wine cooler stand
 Pied pour seau à champagne
 Weinkühlerständer
 Columna porta cubo champany

H cm. 65 H 25 5/8"

912



mm. 1,2
 Secchiello per spumante
 Sparkling wine cooler
 Seau à champagne
 Wein- und Sektkühler
 Cubo para champany

cm. 39 x 36
 H cm. 17,5
 lt. 6
 15 3/8" x 14 1/4"
 H 7"
 gal. 1 3/5

mm. 1,2
 Secchiello per ghiaccio
 Ice-bucket
 Seau à glaçons
 Eisgefäß
 Cubitera hielo

cm. 22 x 20
 H cm. 11,5
 lt. 1,2
 H 4 5/8"
 8 3/4" x 7 7/8"
 oz. 40 1/2

909

910



mm. 1,2
 Secchiello per spumante
 Sparkling wine cooler
 Seau à champagne
 Wein- und Sektkühler
 Cubo para champany

cm. 39 x 36
 H cm. 17,5
 lt. 7
 15 3/8" x 14 1/4"
 H 7"
 gal. 1 4/5

mm. 1,2
 Secchiello per ghiaccio
 Ice-bucket
 Seau à glaçons
 Eisgefäß
 Cubitera hielo

cm. 22 x 20
 H cm. 11,5
 lt. 1,6
 8 3/8" x 7 7/8"
 H 4 5/8"
 oz. 54

899

570



mm. 1,2
Cremiera
Cream jug
Crémier
Sahnegießer/Milchkännchen
Jarrita lechera

Ø cm. 6 Ø 2 3/8"
H cm. 8,8 H 3 1/2"
cl. 16 oz 5 3/8

571



mm. 1,2
Zuccheriera
Sugar bowl
Sucriere
Zuckerdose
Azucarero

Ø cm. 9,5 Ø 3 3/4"
H cm. 6,8 H 2 3/4"
cl. 20 oz 6 3/4

514



mm. 0,8
GIOTTO
Spargisale e Spargipepe
Salt and pepper cellar
Salière et poivrère
Salz und Pepper-streuer
Salero y pimentero

Ø cm. 3 Ø 1 1/6"
H cm. 3 H 1 1/6"
cl. 5 oz. 1 2/3

999C

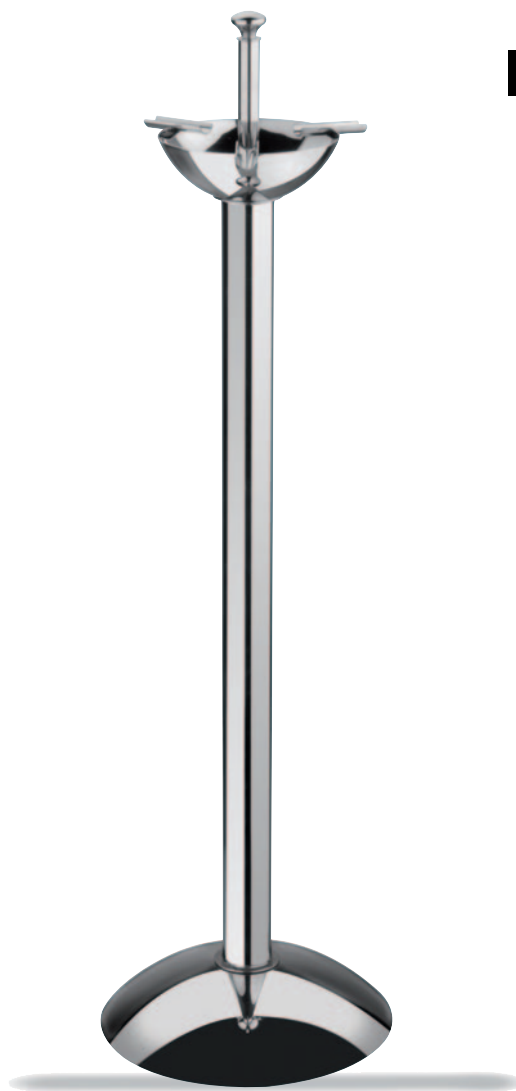

719



mm. 1,2
Bicchieri termico
Insulated shot glass
Shot-verre thermique
Warmhalter Shot Glass
Vaso térmico por chupito

Ø cm. 5 Est. Ø 2" Out.
Ø cm. 4 Int. Ø 1 3/5" Ins.
H cm. 6,3 H 2 1/2"
cl. 6 oz. 2

mm. 1,2
Posacenere a colonna
Ashtray column
Borne étouffoir
Ascherständer
Cenicero à columna

H cm 91,5 H 36"

26202



mm. 1,2 Centrotavola/Fruttieria ovale 2p cm. 46 x 31 18¹/₈" x 12¹/₄"
 Elevated centerpiece/Fruit-bowl cm. 37 x 25 14¹/₂" x 9⁷/₈"
 Centre de table/Compotier H cm. 28 H 11¹/₈"
 Tafelaufsatz/Obstschale lt. 6,5 gal. 1⁵/₇
 Centro de mesa/Fruterio

242



mm. 1,2 Centrotavola/Fruttieria tonda Ø cm. 32 Ø 12⁵/₈"
 Elevated centerpiece/Fruit-bowl H cm. 19 H 7¹/₂"
 Centre de table/Compotier lt. 3,0 oz. 101²/₅
 Tafelaufsatz/Obstschale
 Centro de mesa/Fruterio

26203



mm. 1,2 Centrotavola/Fruttieria ovale 3p cm. 46 x 31 18¹/₈" x 12¹/₄"
 Elevated centerpiece/Fruit-bowl cm. 37 x 25 14¹/₂" x 9⁷/₈"
 Centre de table/Compotier 3et. Ø cm. 12 Ø 4³/₄"
 Tafelaufsatz/Obstschale 3-Stu. H cm. 37 H 14¹/₂"
 Centro de mesa/Fruterio 3pisos lt. 6,7 gal. 1³/₄

24202



mm. 1,2 Centrotavola/Fruttieria tonda 2 piani Ø cm. 32 Ø 12⁵/₈"
 Elevated centerpiece/Fruit-bowl 2t Ø cm. 22 Ø 8⁵/₈"
 Centre de table/Compotier 2 et. H cm. 29,5 H 11³/₅"
 Tafelaufsatz/Obstschale 2-Stufig lt. 4,3 gal. 1¹/₈
 Centro de mesa/Fruterio 2 pisos

26204



mm. 1,2 Centrotavola/Fruttieria ovale 4p cm. 55 x 24 21⁵/₈" x 9¹/₂"
 Elevated centerpiece/Fruit-bowl cm. 46 x 31 18¹/₈" x 12¹/₄"
 Centre de table/Compotier 4et. cm. 37 x 25 14¹/₂" x 9⁷/₈"
 Tafelaufsatz/Obstschale 4-Stu. Ø cm. 12 Ø 4³/₄"
 Centro de mesa/Fruterio 4pisos H cm. 49 H 19¹/₃"
 lt. 7,2 gal. 2

871



mm. 1,2 Cestino portafrutta cm. 24 x 11 9¹/₂" x 4¹/₃"
 Fruit basket
 Panier à fruits
 Obstschale
 Cesto porta frutas

Plateau Royal



PLATEAU ROYAL



252



mm. 1,2 Centrotavola/Fruttieria
Elevated centerpiece/Fruit-bowl
Centre de table/Compotier
Tafelaufsatz/Obstschale
Centro de mesa/Fruterio

cm.38 x 25 15" x 9 7/8"
H cm. 18 H 7 1/8"
cl. 300 oz. 101 1/2

252G



mm. 1,2 Alzata per pesce crudo
Elevated rect.seafood presentation
Serveur à poisson crude
Etagere für marinierten Fisch
Porta pescado

cm.38 x 25 15" x 9 7/8"
H cm. 18 H 7 1/8"
cl. 300 oz. 101 1/2

562V



Rettangolare fondo con vassoio
Rectangular cooling bowl for buffet with insert
Bol rectangulaire à rafraichir avec insert
Kühlschale, rechteckig mit Einsatzteile
Bandeja refrescante rectangular con inserto

cm. 38 x 25
cl. 300

15" x 9 7/8"
oz. 101 1/2

562G



Rettangolare fondo con griglia
Elevated rect.seafood presentation with grill
Bol rectangulaire à rafraichir avec grill
Kühlschale, rechteckig mit Einsatzsieb
Bandeja refrescante rectangular con rejilla

cm. 38 x 25
cl. 300

15" x 9 7/8"
oz. 101 1/2

56422V



Quadro fondo con vassoio
Square cooling bowl for buffet with insert
Bol carré à rafraichir avec insert
Kühlschale, quadr. mit Einsatzteile
Bandeja refrescante cuadrada con inserto

cm. 22x22
cl. 150

8 5/8" x 8 5/8"
oz. 50 3/4

56422G



Quadro fondo con griglia
Square individual seafood presentation with grill
Bol carré à rafraichir avec grill
Kühlschale, quadr. mit Einsatzsieb
Bandeja refrescante cuadrada con rejilla

cm. 22x22
cl. 150

8 5/8" x 8 5/8"
oz. 50 3/4

262G



mm. 1,2 Alzata per pesce crudo
Elevated oval seafood
presentation with grill
Serveur à poisson crude
Etagere für marinierten Fisch
Porta pescado

cm. 46 x 31 18 1/8" x 12 1/4"
H cm. 18 H 7 1/8"
cl. 400 gal. 1

262



mm. 1,2 Centrotavola/Fruttiere
Elevated centerpiece/Fruit-bowl
Centre de table/Compotier
Tafelaufsatz/Obstschale
Centro de mesa/Fruterio

cm. 46 x 31 18 1/8" x 12 1/4"
H cm. 18 H 7 1/8"
cl. 400 gal. 1

558G



Ovale fondo con griglia
Oval seafood presentation with grill
Bol oval à rafraichir avec grill
Kühlschale, oval mit Einsatzsieb
Bandeja refrescante oval con rejilla

cm. 46 x 31
cl. 400
18 1/8" x 12 1/4"
gal. 1

558V



Ovale fondo con vassoio
Oval cooling bowl for buffet with insert
Bol oval à rafraichir avec insert
Kühlschale, oval mit Einsatzteile
Bandeja refrescante oval con inserto

cm. 46 x 31
cl. 400
18 1/8" x 12 1/4"
gal. 1

56022G



Tondo fondo con griglia
Round individual seafood presentation with grill
Bol ronde à rafraichir avec grill
Kühlschale, rund mit Einsatzsieb
Bandeja refrescante redonda con rejilla

Ø cm. 22
cl. 150
Ø cm. 8 5/8"
oz. 50 3/4

56022V



Tondo fondo con vassoio
Round cooling bowl for buffet with insert
Bol ronde à rafraichir avec insert
Kühlschale, rund mit Einsatzteile
Bandeja refrescante redonda con inserto

Ø cm. 22
cl. 150
Ø cm. 8 5/8"
oz. 50 3/4

242G



mm. 1,2 Alzata tonda per pesce crudo Ø cm.32 Ø 12 5/8"
Elevated round thirty-two stand H cm. 19 H 7 1/2"
Serviteur ronde à poisson crude lt. 3,0 oz. 101 2/5
Etagere, rund, für marinierte
Fisch Ø cm.22 Ø 8 5/8"
Porta pescado redondo H cm. 18 H 7 1/8"
lt. 1,31 oz. 44 1/3

26202G



mm. 1,2 Alzata ovale per pesce crudo 2p cm. 46 x 31 18 1/8" x 12 1/4"
Oval two tier seafood stand cm. 37 x 25 14 1/2" x 9 7/8"
Serviteur ovale à poisson crude H cm. 28 H 11 1/8"
Etagere, oval, für marinierten gal. 1 5/7
Fisch lt. 6,5
Porta pescado oval 2 pisos

24202G



mm. 1,2 Alzata tonda per pesce crudo 2p Ø cm. 32 Ø 12 5/8"
Round two tier seafood stand Ø cm. 22 Ø 8 5/8"
Servit.ronde à poisson crude 2 et. H cm. 29,5 H 11 3/5"
Etagere, rund, für marinierte Fisch lt. 4,3 gal. 1 1/8
2-Stufig
Porta pescado redondo 2 pisos

26203G



mm. 1,2 Alzata ovale per pesce crudo 3p cm. 46 x 31 18 1/8" x 12 1/4"
Oval three tier seafood stand cm. 37 x 25 14 1/2" x 9 7/8"
Serviteur ovale à poisson crude Ø cm. 12 Ø 4 3/4"
Etagere, oval, für marinierten H cm. 37 H 14 1/2"
Fisch 3 -Stufig lt. 6,7 gal. 1 3/4
Porta pescado oval 3 pisos

485

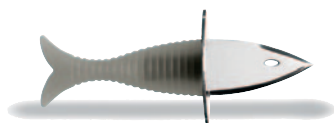

APRIL cm. 15 5 7/8"
Coltello per ostriche
Oyster knife
Couteau à huîtres
Austernöffner
Cuchillo de ostras

26204G



mm. 1,2 Alzata ovale per pesce crudo 4p cm. 55 x 24 21 5/8" x 9 1/2"
Oval four tier seafood stand cm. 46 x 31 18 1/8" x 12 1/4"
Serviteur ovale à poisson crude cm. 37 x 25 14 1/2" x 9 7/8"
Etagere, oval, für marinierten Ø cm. 12 Ø 4 3/4"
Fisch 4-Stufig H cm. 49 H 19 1/3"
Porta pescado oval 4 pisos lt. 7,2 gal. 2

235G

235



mm. 1,2 Vassoio rotondo per pesce crudo Ø cm.38 Ø 15"
 Round seafood tray H cm. 9 H 3 1/2"
 Plateau rond à poisson crude lt. 3,0 oz. 101 2/5
 Tablett, rund für marinierten Fisch
 Porta pescado redondo

mm. 1,2 Centrotavola/Fruittiera Ø cm.38 Ø 15"
 Centerpiece/Fruit-bowl H cm. 9 H 3 1/2"
 Centre de table/Compotier lt. 3,0 oz. 101 2/5
 Tafelaufsatz/Obstschale
 Centro de mesa/Fruterio



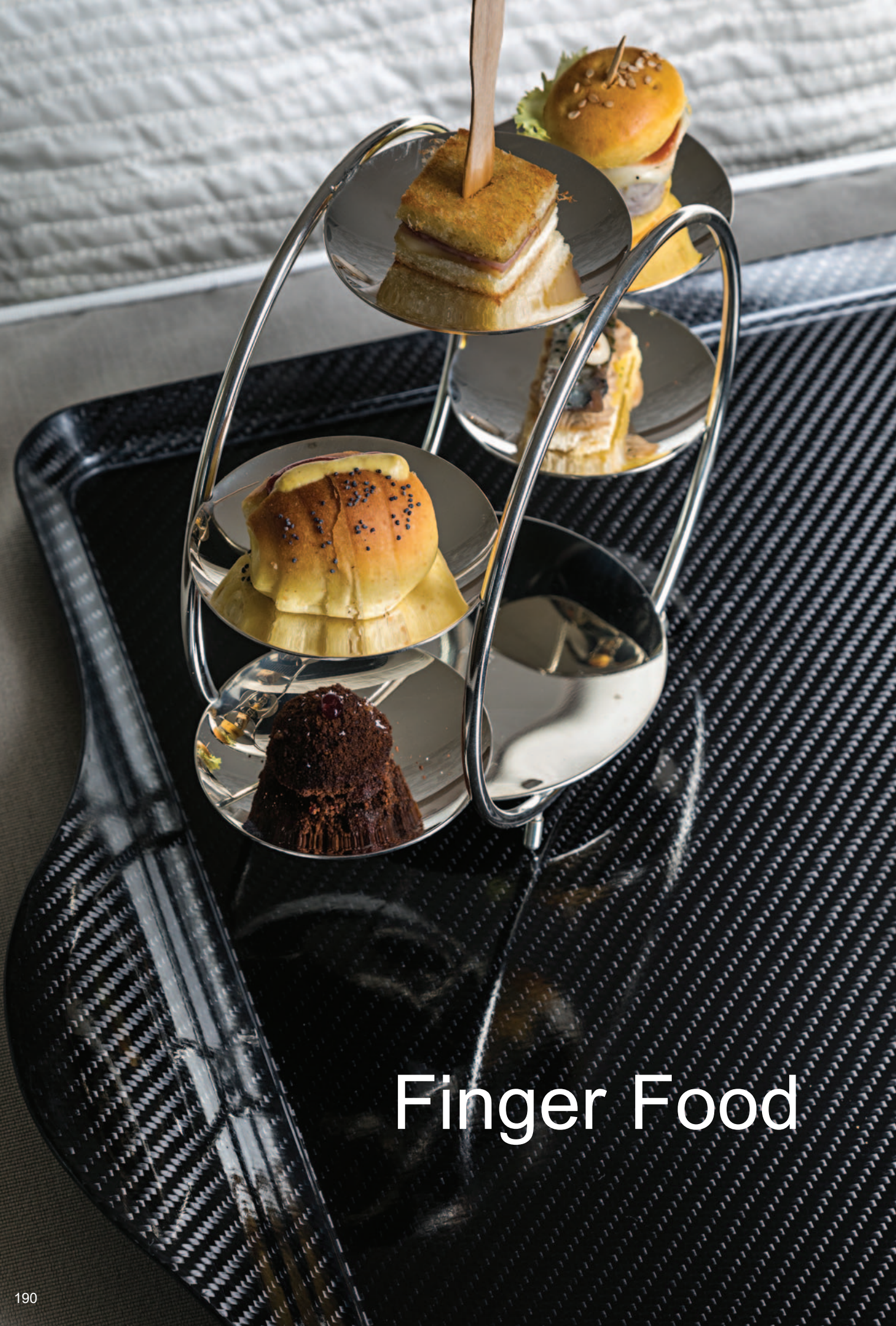

Finger Food

10001129



mm. 2,5 Quarta posata

Lungh. cm. 22,2 Length 8 3/4"

25506



mm. 1,2 Micro presentoir

H cm. 13 H 5 1/9"
 Ø cm. 6 (x5) Ø 2 1/3" (x5)
 Ø cm. 8 Ø 3 1/7"

25508



mm. 1,2 Mini presentoir

H cm. 17 H 6 5/8"
 Ø cm. 8 (x5) Ø 3 1/7" (x5)
 Ø cm. 11 Ø 4 3/8"



10341146

NEW

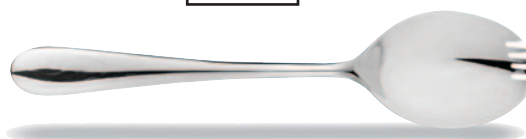

mm. 3,0 Cucchiaino multifunzione
 Multifunctional spoon
 Cuillère multifonctionnelle
 Multifunktionaler Löffel
 Cuchara multifuncional

cm. 17,6 6 8/9"

537

53706



53712



mm. 1,2 Mini vassoio quadro 6/12 comp. cm. 12 x 12 4 3/4" x 4 3/4"
6/12 comp. Mini square tray cm. 15 x 15 5 7/8" x 5 7/8"
Mini plateau carré 6/12 pos.
Mini Tablett, eckig., 6/12 Eins.
Mini bandeja cuadrada 6/12 p.

549



mm. 1,2 Vassoio rettangolare 14 comp. cm 45 x 28 17 3/4" x 11 1/8"
Rectangular tray 14 comp.
Plateau rectangulaire 14 plac.
Tablett, rechteckig 14 Eins.
Bandeja rectangular 14 posic.

520

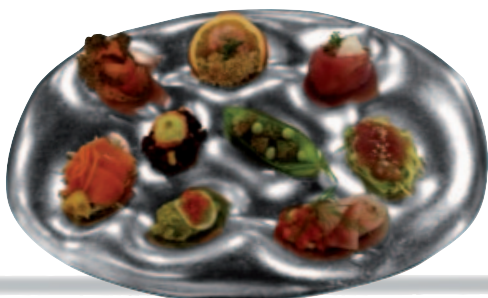

mm. 1,2 Vassoio ovale 9 compart. cm. 35 x 25,5 13 3/4" x 10"
Oval tray 9 compartments
Plateau oval 9 comp.
Tablett, oval, 9 Einsätze
Bandeja oval 9 posiciones

791E

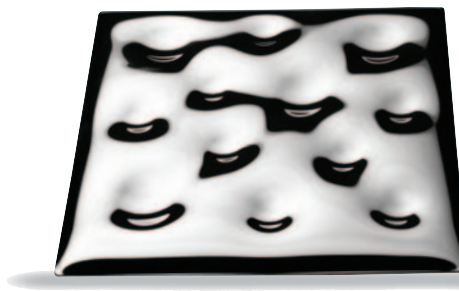

mm. 1,2 Vassoio da buffet per uova cm. 30 x 30 11 7/8" x 11 7/8"
Egg tray for buffet
Plateau à oeufs pour buffet
Egg-tablett für Buffet
Bandeja porta huevos por buffet

52922



mm. 1,2 Vassoio quadro 8 compart. cm. 22 x 22 8 5/8" x 8 5/8"
8 comp. Square tray
Plateau carré 8 pos.
Tablett, eckig., 8 Eins.
Bandeja cuadrada 8 posic.

526

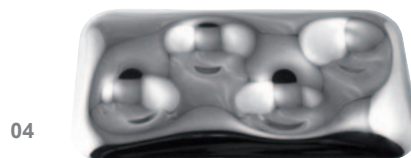

04



03

mm. 1,2 Vassoio rettangolare a 3 o 4 comp. cm. 23 x 13 9" x 5 1/8"
Rectangular tray 3 or 4 comp.
Plateau rectangulaire 3 ou 4 plac.
Tablett, rechteckig 3 oder 4 Eins.
Bandeja rectangular 3 o 4 posic.

FINGER FOOD

791AC



mm. 1,2 Insetto per finger food
Finger food insert
Insért pour finger food
Finger food Einsatz
Insetto por finger food

cm. 30 x 30 117/8" x 117/8"

791



Vassoio/Sottopiatto
Square Tray/Charger
Plateau/Assiette de bienvenue
Tablett/Platzteller,
Bandeja/Bajo plato

cm. 32 x 32 12³/₄" x 12³/₄"

700



mm. 1,2 Portapatatine fritte
French fry holder for table
Porte pommes frites pour table
Kartoffenbehälter für Tisch
Porta patatas fritas por mesa

H cm 10 H 4"
cl. 35 oz. 11 7/8

902



mm. 1,2 Portapatatine fritte
French fry holder for table
Porte pommes frites pour table
Kartoffenbehälter für Tisch
Porta patatas fritas por mesa

H cm 8 H 3 1/4"
Ø cm 7 Ø 2 3/4"

260



mm. 1,2 Portapatatine fritte
French fry holder for table
Porte pommes frites pour table
Kartoffenbehälter für Tisch
Porta patatas fritas por mesa

Ø cm 10 H 3 3/4"
H cm 9,5 Ø 3 7/8"

289



mm. 1,2 Portapatatine fritte
French fry holder for table
Porte pommes frites pour table
Kartoffenbehälter für Tisch
Porta patatas fritas por mesa

H cm. 10 H 3 7/8"
Ø cm. 6 Ø 2"

53012



mm. 1,2 23053012
Mini vaporiera
Mini steamer
Mini vaporisateur
Mini Verdampfer
Mini vaporizador

Ø cm. 12 Ø 4 3/4"
H cm. 14,5 H 5 3/4"
cl. 24 oz. 8

53022



mm. 1,2 23053022
Vaporiera
Steamer
Vaporisateur
Verdampfer
Vaporizador

Ø cm. 32 Ø 12 5/8"
H cm. 26 H 10 1/4"
lt. 3,0 oz. 101 2/5



FINGER FOOD

557T



557

557T

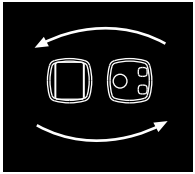

Combinabile con
Ciotole in vetro
Ciotole in policarbonato
Ciotole in porcellana
Coperchio in acciaio
inossidabile 18/10

Combinable with
Glass bowls
Polycarbonate bowls
China bowls
18/10 st.st. lid

Combinable avec
Bols en verre
Bols en Polycarbonat
Bols en porcelaine
Couvercle en acier
inoxydable18/10

Kombinierbar mit
Glasschalen
Polycarbonatschalen
Porzellanschalen
18/10-Deckel

Combinable con
Cuencos en cristal
Cuencos en policarbonato
Cuencos en China
Tapa en acero inoxidable
18/10

561M



56138

561M

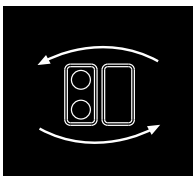

Combinabile con
Ciotole in vetro
Ciotole in policarbonato
Vassoio in acciaio
inossidabile 18/10

Combinable with
Glass bowls
Polycarbonate bowls
Tray in 18/10
stainless steel

Combinable avec
Bols en verre
Bols en Polycarbonat
Plateau en acier
inoxydable18/10

Kombinierbar mit
Glasschalen
Polycarbonatschalen
Edelstahlschalen

Combinable con
Cuencos en cristal
Cuencos en policarbonato
Cuencos en acero
inoxidable 18/10

561T

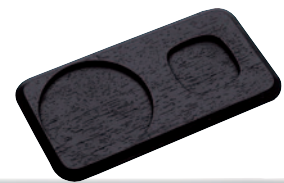

561T

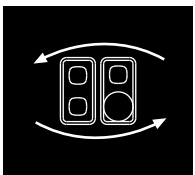

Combinabile con
Ciotole in vetro
Ciotole in policarbonato
Ciotole in porcellana
Coperchio in acciaio
inossidabile 18/10
Ampolle in vetro
Piatti in vetro

Combinable with
Glass bowls
Polycarbonate bowls
China bowls
18/10 st.st. lid
Glass bottles
Glass trays

Combinable avec
Bols en verre
Bols en Polycarbonat
Bols en porcelaine
Couvercle en acier
inoxydable18/10
Bouteilles en verre
Plateaus en verre

Kombinierbar mit
Glasschalen
Polycarbonatschalen
Porzellanschalen
18/10-Deckel
Karaffen
Glasplatten

Combinable con
Cuencos en cristal
Cuencos en policarbonato
Cuencos en China
Tapa en acero inoxidable
18/10
Botellas en vidrio
Platos en vidrio

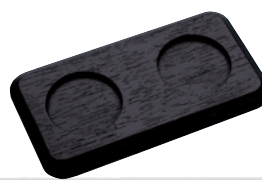

56122

561M

561T

FINGER FOOD

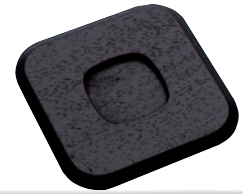

563T15

56315

563T15

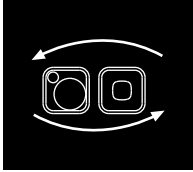

Combinabile con
Ciotole in vetro
Ciotole in policarbonato
Ciotole in porcellana
Coperchio in acciaio
inossidabile 18/10
Ampolle in vetro

Combinable with
Glass bowls
Polycarbonate bowls
China bowls
18/10 st.st. lid
Glass bottles

Combinable avec
Bols en verre
Bols en Polycarbonat
Bols en porcelaine
Couvercle en acier
inoxydable 18/10
Bouteilles en verre

Kombinierbar mit
Glasschalen
Polycarbonatschalen
Porzellanschalen
18/10-Deckel
Karaffen

Combinable con
Cuencos en cristal
Cuencos en policarbonato
Cuencos en China
Tapa en acero inoxidable
18/10
Botellas en vidrio



563T22

56322

563T22

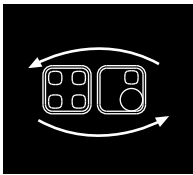

Combinabile con
Ciotole in vetro
Ciotole in policarbonato
Ciotole in porcellana
Coperchio in acciaio
inossidabile 18/10
Ampolle in vetro

Combinable with
Glass bowls
Polycarbonate bowls
China bowls
18/10 st.st. lid
Glass bottles

Combinable avec
Bols en verre
Bols en Polycarbonat
Bols en porcelaine
Couvercle en acier
inoxydable 18/10
Bouteilles en verre

Kombinierbar mit
Glasschalen
Polycarbonatschalen
Porzellanschalen
18/10-Deckel
Karaffen

Combinable con
Cuencos en cristal
Cuencos en policarbonato
Cuencos en acero
inoxidable 18/10
Botellas en vidrio



563T22

567

563T22

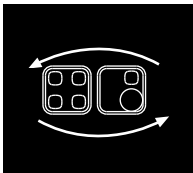

Combinabile con
Ciotole in vetro
Ciotole in policarbonato
Ciotole in porcellana
Coperchio in acciaio
inossidabile 18/10
Ampolle in vetro

Combinable with
Glass bowls
Polycarbonate bowls
China bowls
18/10 st.st. lid
Glass bottles

Combinable avec
Bols en verre
Bols en Polycarbonat
Bols en porcelaine
Couvercle en acier
inoxydable 18/10
Bouteilles en verre

Kombinierbar mit
Glasschalen
Polycarbonatschalen
Porzellanschalen
18/10-Deckel
Karaffen

Combinable con
Cuencos en cristal
Cuencos en policarbonato
Cuencos en acero
inoxidable 18/10
Botellas en vidrio



578

577

584

587

585

572

572A

352

A close-up photograph of a silver heart-shaped mold being used to pour red wine into a matching heart-shaped dish. The mold is held over the dish, and a stream of red wine is being poured from it. The scene is set on a white, textured napkin placed on a wooden tray. In the background, a white ceramic cup is being poured with red wine. The overall composition is elegant and focused on the heart-shaped objects.

748
Porta sorpresa

Specialist



260 Vaso

703AC Piattino



744
Cestino

750
Microforchetta



753
Alzata

920
Appoggia posate



919
Cestino Palace



Quarta Posata

754
Vassoio

748



mm. 1,2 Porta sorpresa
Surprises set
Porte-surprises
Universalträger
Puerta sorpresas

703AC



mm. 1,2 Piattino
Tray
Plat
Tablett
Bandeja

Ø cm. 10 Ø 3 7/8"

260



mm. 1,2 Vaso
Jar
Vase
Vase
Florero

H cm. 9,5 H 3 3/4"
Ø cm. 10 Ø 3 7/8"

744



mm. 1,2 Cestino
Basket
Corbeille
Früchtekorb
Cesta

H cm. 11,5 H 4 1/2"
Ø cm. 10 Ø 3 7/8"

750



mm. 1,5 Micro forchetta
Micro fork
Micro fourchette
Mikrogabel
Micro tenedor

743



mm. 1,2 Cestino
Basket
Corbeille
Früchtekorb
Cesta

H cm. 11,5 H 4 1/2"
Ø cm. 10 Ø 3 7/8"

753



mm. 1,2 Alzata
Holder
Serviteur
Etagere
Frutero

H cm. 16 H 6 1/3"
Ø cm. 12 Ø 4 3/4"

920



mm. 1,2 Appoggia posate cm. 10 x 8 4" x 3 1/7"
Knife rest
Soutier p/couverters
Besteck Ablage
Apoyo p/cubiertos

919



mm. 1,2 Cestino con maniglie
Basket with handles
Corbeille avec poignée
Schale mit Griffen
Frutero con asas

H cm. 11,5 H 4 1/2"
Ø cm. 12 Ø 4 3/4"
cl. 26 oz 8 4/5

754



mm. 1,2 Vassoio con fori
Tray with holes
Plateau avec trous
Tablett mit Löchern
Bandeja con agujeros

Ø cm. 28,5 Ø 11 1/5"

523



mm. 1,2 Mini cestello con coperchio
Mini basket with lid
Mini corbeille avec couvercle
Mini Schale mit Deckel
Mini cuenco con tapa

H cm. 10 H 4"
Ø cm. 9,4 Ø 3 5/7"

739



mm. 1,2 Cestino con coperchio
Basket with lid
Corbeille avec couvercle
Schale mit Deckel
Cuenco con tapa

H cm. 16 H 6 1/3"
Ø cm. 12 Ø 4 3/4"
cl. 26 oz 8 4/5

718



mm. 1,2 Tumbler

H cm. 8,2 H 3 1/4"
 Ø cm. 7,2 Ø 3 4/5"
 cl. 30 oz. 10 1/7

916



mm. 1,2 Poggia pane
 Tray for bread
 Plateau pour pan
 Brot Tablett
 Bandeja por pan

Ø cm. 19,7 Ø 7 3/4"

918

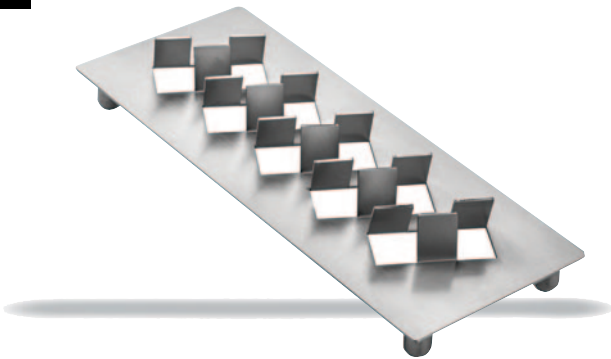

mm. 1,2 Porta crackers
 Crackers holder
 Porte craquelins
 Cracker Schale
 Puerta galletas saladas

cm. 20 x 8 7 7/8" x 3 1/7"

872



mm. 1,2 Portagrissini
 Bread sticks tray
 Porte gressin
 Grissini Schale
 Cuenco porta bastoncillos
 de pan

cm. 24 x 6 H 9 3/8" x 2 2/3"

717



mm. 1,2 Saucière cl. 4 oz. 4

738



mm. 1,2 GIOTTO
 Coppetta con vassoio
 Cup and tray
 Coupe avec plateau
 Schale mit Tablett
 Cuenco con bandeja

Ø cm. 9
 Ø 3 1/2"

Coppetta amouse bouche
 Appetizer bowl
 Bol multi-usages
 Fingerfood-/Vorspeisen-/Butter-
 Gefäß
 Cuenco para finger food/amouse
 bouche

cm. 13 x 7
 cl. 4
 5 1/9" x 2 3/4"
 oz. 4

740



745
Vassoio
petit four



742
Piattino pasticceria



747
Porta bon bon



Vassoio petit four
745



990
Coppetta con vassoio



745
Vassoio petit four



742
Piattino
pasticceria



746
Vassoietto
petit four



914



mm. 1,2 PALACE
Vassoietto
Tray
Plateau
Tablett
Bandeja

cm. 13 x 7 5 1/9" x 2 3/4"

737



mm. 1,2 GIOTTO
Vassoietto
Tray
Plateau
Tablett
Bandeja

cm. 13 x 7 5 1/9" x 2 3/4"

745



mm. 1,2 Vassoio petit four
Petit-fours tray
Plateau petit-fours
Petit-Fours Tablett
Porta dulces

cm. 26 10 1/4"

746



mm. 1,2 Vassoietto petit four
Petit-fours tray
Plateau petit-fours
Petit-Fours Tablett
Porta dulces

cm. 17,5 6 7/8"

742



Piattino per pasticceria H cm. 17,5 H 6 7/8"
Petit-fours stand Ø cm. 14 Ø 5 1/2"
Porte-petit fours
Mokkaétagère
Porta dulces
mm. 1,2

990



PALACE
Coppetta con vassoio
Cup and tray
Coupe avec plateau
Schale mit Tablett
Cuenco con bandeja
mm. 1,2

H cm. 11,5 H 4 1/2"
Ø cm. 10 Ø 3 7/8"

747



Cestino H cm. 11,5 H 4 1/2"
Basket Ø cm. 10 Ø 3 7/8"
Corbeille
Früchtekorb
Cesta
mm. 1,2

990



738



746
Vassoietto
petit four

914
Vassoietto
Palace



737
Vassoietto
Giotto





Fashion

403

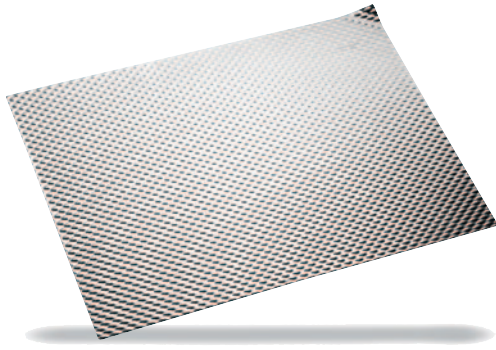

mm. 1,0
Tovaglietta americana
Place mat
Set de table americain
Tischset
Individual en acero

cm. 41 x 31 16 2/5" x 12 1/4"

420

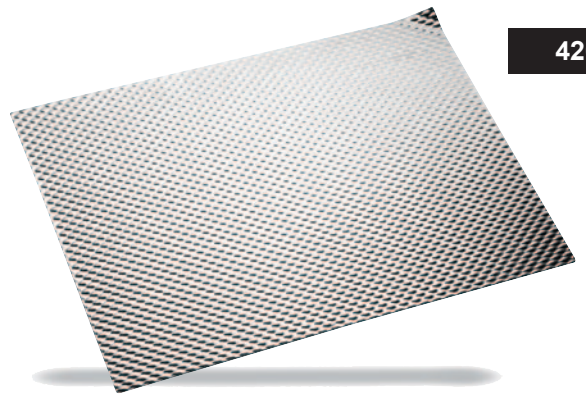

Vassoio gastronorm 1/1
Tray gastronorm 1/1
Plateau gastronorm 1/1
Tablett, gastronorm 1/1
Bandeja gastronorm 1/1

mm. 1,0 cm. 53 x 32,5 20 3/4" x 12 2/3"

416

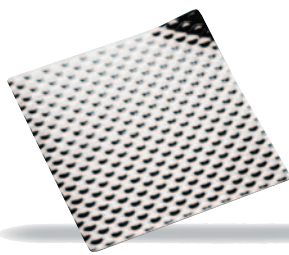

mm. 1,0 Vassoio finger food
Finger food tray
Plateau pour finger food
Finger Food Tablett
Bandeja por finger food

cm. 20 x 20
7 7/8" x 7 7/8"

404

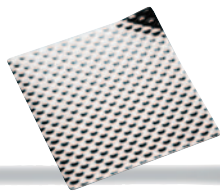

Portapane/Sottobottiglia
Bread tray/Bottle coaster
Brot Tablett/Flaschenteller
Porte pan/Dessous de
bouteille
Portapan/Posabotella

cm. 12,5 x 12,5
5" x 5"

426



mm. 1,0 Portastuzzicadenti
Toothpick container
Porte-cure-dents
Zahnstocherbehälte
Porta-palillos

cm. 11 x 3
4 1/3" x 1 1/5"

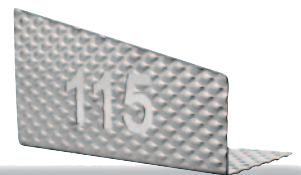

Numero da tavola
Table number stand
Numéro de table
Tischnummer-Ständer
Numero de mesa

cm. 15 x 8
6" x 3 1/7"

422

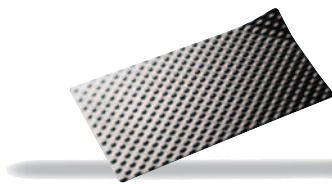

mm. 1,2 Vassoio amouse bouche
Amouse bouche tray
Plateau amouse bouche
Amouse bouche Tablett
Bandeja amouse bouche

cm. 20 x 10 7 7/8" x 4"

418

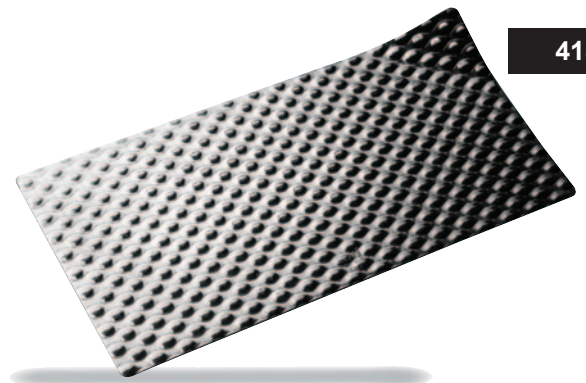

mm. 1,0 Vassoio gastronorm 2/4
Tray gastronorm 2/4
Plateau gastronorm 2/4
Tablett, gastronorm 2/4
Bandeja gastronorm 2/4

cm. 53 x 16,2 20 3/4" x 6 3/8"

417

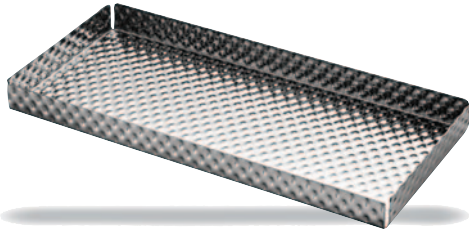

mm. 1,0 Cestino per pane e grissini cm. 26 x 12 10 1/4" x 4 3/4"
 Bread/Bread sticks basket
 Corbeille pour pan et gressin
 Brot- und Grissinikorb
 Cesta por pan y bastoncillos de pan

419

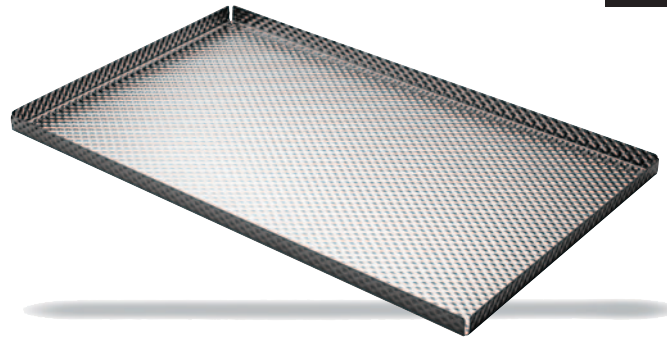

mm. 1,0 Vassoio gastronom c/bordo cm. 53 x 32,5 20 3/4" x 12 2/3"
 Tray gastronom w/edges
 Plateau gastronom a/bords
 Tablett, gastronom m/Kanten
 Bandeja gastronom c/bordes

429

NEW

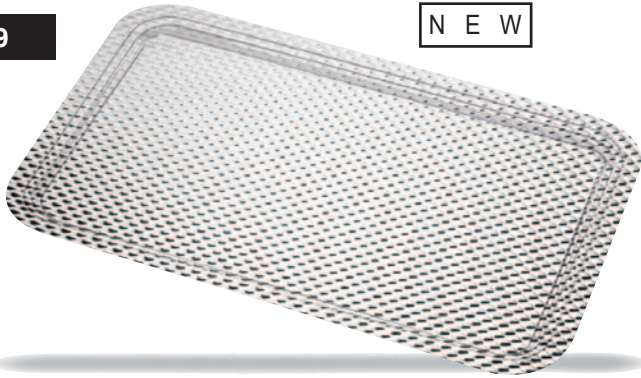

mm. 1,0 Vassoio per carrelli cm. 45 x 31 17 3/4" x 12 1/4"
 Tray for rack trolley cm. 63 x 45 24 11/16" x 17 3/4"
 Plateau pour chariot porte-plateau
 Tablett für Rack
 Bandeja para estante

NEW

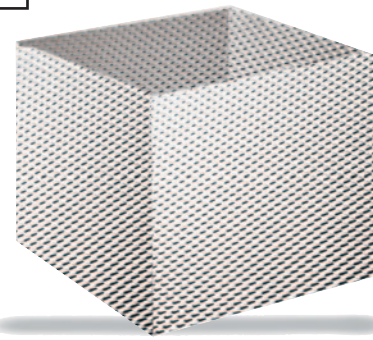

mm. 1,0 Secchiello per spumante H cm. 21 H 8 1/4"
 Sparkling wine cooler cm. 21 x 21 8 1/4" x 8 1/4"
 Seau à champagne lt. 9 gal. 2 1/2
 Wein- und Sektkühler
 Cubo para champany

430

427

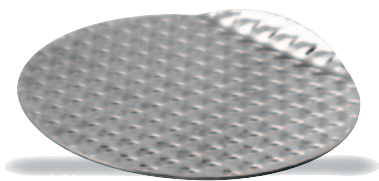

mm. 1,0 Sottobottiglia Ø cm. 10 Ø 4"
 Bottle coaster
 Dessous de bouteille
 Flaschenteller
 Posabotella

428

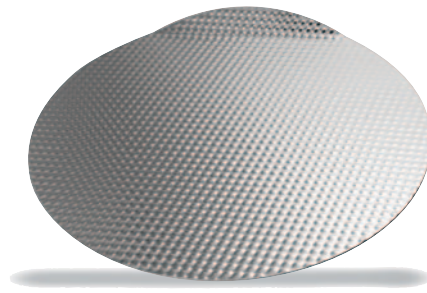

mm. 1,0 Sottopiatto Ø cm. 34 Ø 13 3/8"
 Charger
 Assiette de bienvenue
 Platzteller
 Bajo plato





Buffet 4.0

212A



mm. 1,2 Centrotavola/Fruttierra cm. 38 x 25 15" x 9 7/8"
Elevated centerpiece/Fruit-bowl H cm. 20 H 7 3/4"
Centre de table/Compotier
Tafelaufsatz/Obstschale
Centro de mesa/Fruterero

222A



mm. 1,2 Centrotavola/Fruttierra cm. 46 x 31 18 1/4" x 12 1/4"
Elevated centerpiece/Fruit-bowl H cm. 20 H 7 3/4"
Centre de table/Compotier
Tafelaufsatz/Obstschale
Centro de mesa/Fruterero

212



mm. 1,2 Centrotavola/Fruttierra cm. 38 x 25 15" x 9 7/8"
Elevated centerpiece/Fruit-bowl H cm. 13,2 H 5 1/5"
Centre de table/Compotier
Tafelaufsatz/Obstschale
Centro de mesa/Fruterero

222



mm. 1,2 Centrotavola/Fruttierra cm. 46 x 31 18 1/4" x 12 1/4"
Elevated centerpiece/Fruit-bowl H cm. 13,2 H 5 1/5"
Centre de table/Compotier
Tafelaufsatz/Obstschale
Centro de mesa/Fruterero

561



mm. 1,2 Rettangolare piano cm. 23 x 13 9" x 5 1/8"
Rectangular tray cm. 38 x 25 15" x 9 7/8"
Plateau rectangulaire
Tablett, rechteckig
Bandeja rectangular

557



mm. 1,2 Ovale piano cm. 37 x 25 14 1/2" x 9 7/8"
Oval tray cm. 46 x 31 18 1/4" x 12 1/4"
Plateau, oval
Tablett, oval
Bandeja oval

Colori disponibili
Available colors
Couleurs disponibles
Verfügbare Farben
Colores disponibles



O Onice
Onyx
Onyx
Onyx
Onice



N Nero
Black
Noir
Schwarz
Negro



W Trasparente
Transparent
Glace
Transparent
Vidrio



P Porcellana
White
Porcelain
Weiss
Porcelana



Cereali

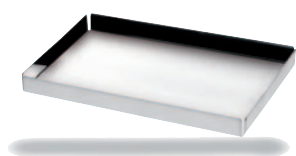

265
Vassoio per pasticceria
Patisserie tray
Plateau pour patisserie
Patisserie Tablett
Bandeja para pasteleria

cm. 24,5 x 17
cm. 30 x 21
cm. 34 x 24

9 5/8" x 6 3/4"
11 3/4" x 8 1/4"
13 3/8" x 9 1/2"

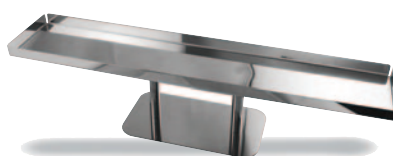

205
Vassoio per pasticceria c/pied.
Patisserie tray with foot
Plateau pour patisserie a/socle
Patisserie Tablett mit Fuss
Bandeja para pasteleria c/pies

cm. 26 x 12
cm. 60 x 12
H cm. 13

10 1/4" x 4 3/4"
23 3/5" x 10 1/5"
H 5 1/9"

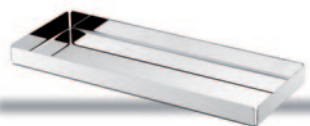

206
Vassoio per pasticceria
Patisserie tray
Plateau pour patisserie
Patisserie Tablett
Bandeja para pasteleria

cm. 26 x 12
cm. 60 x 12

10 1/4" x 4 3/4"
23 3/5" x 10 1/5"



270
Portatovaglioli
Napkin holder
Distributeur de serviettes
Serviettenhalter
Portaservilletas

cm. 12,5 x 4,5
H cm. 7

5" x 1 7/8"
H 2 3/4"

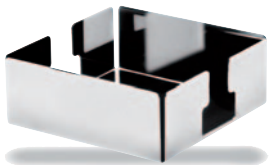

704
Portatovaglioli
Napkin holder
Distributeur de serviettes
Serviettenhalter
Portaservilletas

cm. 13 x 13

5 1/9" x 5 1/9"



516
Portabustine da zucchero
Sugar packet holder
Pot à sucre
Zuckerstangengefäß
Azucarera

cm. 10 x 7
H cm. 3

4" x 2 3/4"
H 1 1/8"



150
Piatto concavo
Crescent plate
Plateau concave
Konkave Platte
Plato concavo

Ø cm. 14 Ø 5 1/2"
Ø cm. 18 Ø 7"
Ø cm. 20 Ø 7 7/8"
Ø cm. 22 Ø 8 5/8"
Ø cm. 24 Ø 9 1/2"
Ø cm. 26 Ø 10 1/4"
Ø cm. 28 Ø 11"



744
Cestino
Basket
Corbeille
Früchtekorb
Cesta

H cm. 11,5
Ø cm. 10

H 4 1/2"
Ø 3 7/8"

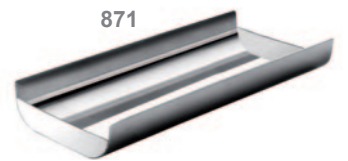

871

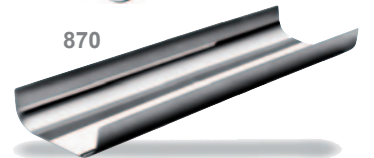

870

870 - 871
GIOTTO
Portapane / Portagrissini
Bread / Bread sticks holder
Porte pan / Porte gressin
Brot und-Grissini -Schale
Portapan / Porta bastoncillos de pan

870
cm. 35,5 x 11
14" x 4 1/3"

871
cm. 24 x 11
9 1/2" x 4 1/3"

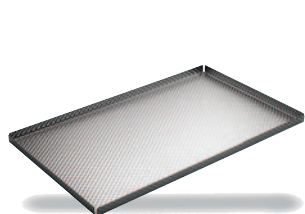

419
FASHION
Vassoio gastronom c/bordo 1/1
Tray gastronom w/edges 1/1
Plateau gastronom a/bords 1/1
Tablett, gastronom m/Kanten 1/1
Bandeja gastronom c/bordes 1/1

cm. 53 x 32,5

20 3/4" x 12 2/3"

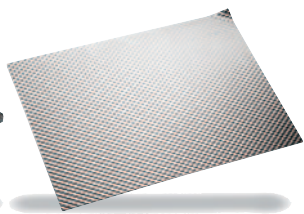

420
FASHION
Vassoio gastronom 1/1
Tray gastronom 1/1
Plateau gastronom 1/1
Tablett, gastronom 1/1
Bandeja gastronom 1/1

cm. 53 x 32,5

20 3/4" x 12 2/3"

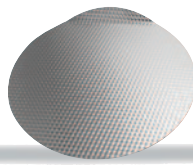

428
FASHION
Sottopiatto
Charger
Assiette de bienvenue
Platzteller
Bajo plato

Ø cm. 34

Ø 13 3/8"

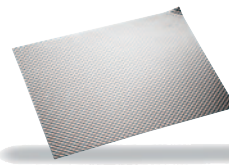

403
FASHION
Tovaglietta americana
Place mat
Set de table americain
Tischset
Individual en acero

cm. 41 x 31

12 1/4" x 16 2/5"

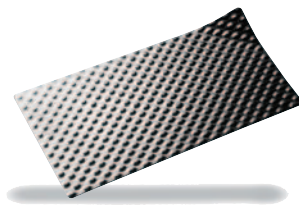

418
FASHION
Vassoio gastronom 2/4
Tray gastronom 2/4
Plateau gastronom 2/4
Tablett, gastronom 2/4
Bandeja gastronom 2/4

cm. 53 x 16,2

20 3/4" x 6 3/8"

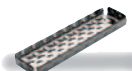
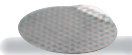
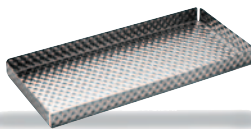
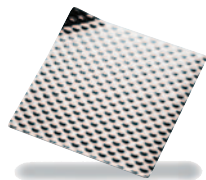
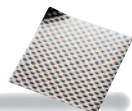
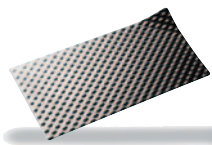

422
FASHION
Vassoio amouse buche
Amouse buche tray
Plateau amouse buche
Amouse buche Tablett
Bandeja amouse buche

cm. 20 x 10

7 7/8" x 4"

404
FASHION
Portapanne/Sottobottiglia
Bread tray/Bottle coaster
Porte pan/Dessous de
bouteille
Brot Tablett/Flaschenteller
Portapan/Posabotella

cm. 12,5 x 12,5

5" x 5"

416
FASHION
Vassoio finger food
Finger food tray
Plateau pour finger food
Finger Food Tablett
Bandeja por finger food

cm. 20 x 20

7 7/8" x 7 7/8"

417
FASHION
Cestino per pane e grissini
Bread/Bread sticks basket
Corbeille pour pan et gressin
Brot- und Grissinikorb
Cesta por pan y bastoncillos
de pan

cm. 26 x 12

10 1/4" x 4 3/4"

427
FASHION
Sottobottiglia
Bottle coaster
Dess.de bouteille
Flaschenteller
Posabotella

Ø cm. 10

Ø 4"

423
FASHION
Portastuzzicadenti/Appoggiaposate
Toothpick container/Knife rest
Porte-cure-dents/Soutier p/couverts
Zahnstocherbehälter/Messer bank
Porta-palillos/Apoyo p/cubiertos

cm. 11 x 3

4 1/3" x 1 1/5"



391
H cm. 13
H 5 1/8"



387
H cm. 10
H 4"



382
H cm. 7,5
H 3"



383
H cm. 5,5
H 2 1/6"

Basi
Risers
Stands de buffet
Buffetständer
Soportes de buffet



390
H cm. 6
H 2 1/3"



388
H cm. 7,4
H 2 7/8"



389
H cm. 14
H 5 1/2"



386
H cm. 7,5
H 3"



385
H cm. 3,0
H 1 1/4"



384
H cm. 8,5
H 3 3/8"



Buffet

682



TU0687G

mm. 0,8

Caraffa per bibite
Jug for drinks w/ice container
Carafe avec compartiment glaçons
Saftkrug mit Kühleinsatz
Jarra agua

lt. 2,5 84 1/2 oz.

691



TU0692V

mm. 0,8

Infusiera con contenitore trasparente
Infuser jug
Carafe d'eau avec infuseur
Wasserkrug mit Infuser
Jarra de agua de infusión

lt. 2,5 84 1/2 oz.

68702



TU0687G

mm. 0,8

AURORA
Caraffa per bibite
Jug for drinks w/ice container
Carafe avec compartiment glaçons
Saftkrug mit Kühleinsatz
Jarra agua

lt. 2 67 3/4 oz.

69202



TU0692V

mm. 0,8

AURORA
Infusiera con contenitore trasparente
Infuser jug
Carafe d'eau avec infuseur
Wasserkrug mit Infuser
Jarra de agua de infusión

lt. 2 67 3/4 oz.

BUFFET

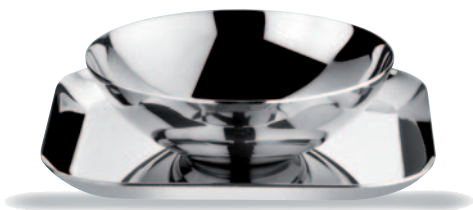
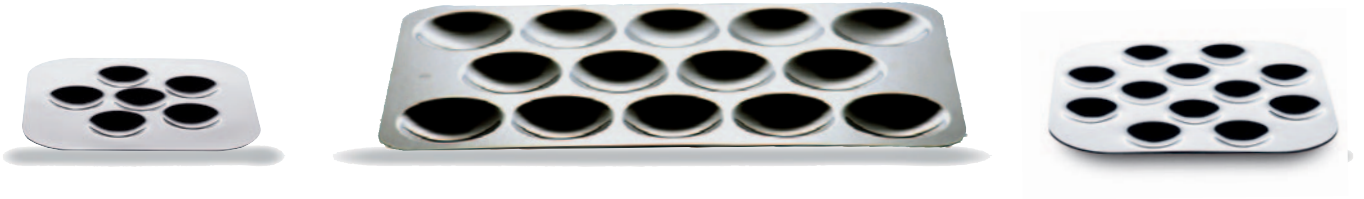



549

537



mm. 1,2 Centrotavola
Tray 14 compartments
Plateau 14 pièces
Tablett 14 Einsätze
Bandeja 14 posiciones

53706



cm. 45 x 28 17³/₄" x 11¹/₈"

mm. 1,2 Mini vassoi per finger food
Mini trays for finger food
Mini plateau pour finger food
Mini Tablett für finger food
Mini bandejas por finger food

53712



cm. 12 x 12 4³/₄" x 4³/₄"
cm. 15 x 15 5⁷/₈" x 5⁷/₈"

7011

7011E



cl. 9 - oz. 3

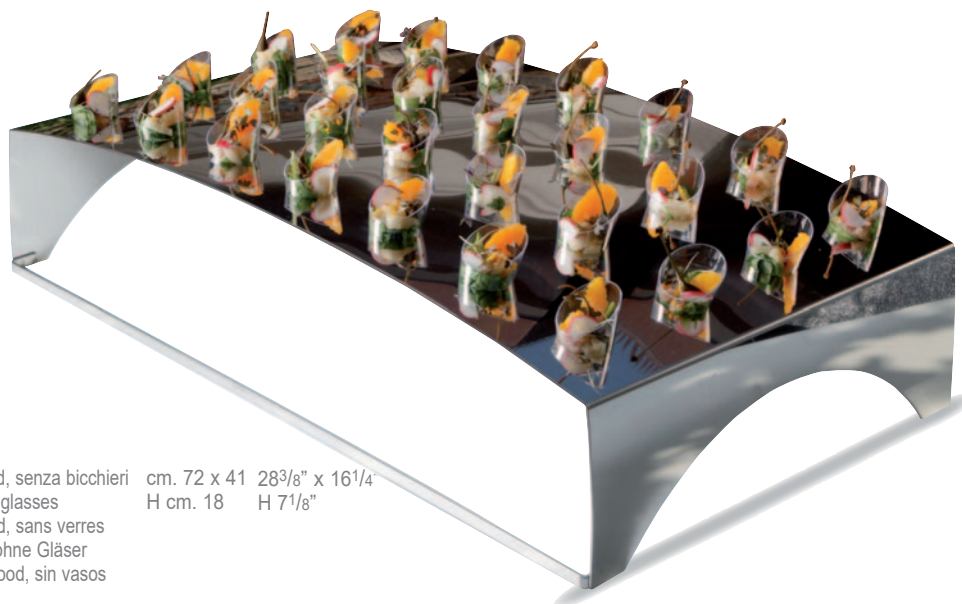

mm. 1,2 Espositore buffet per finger food, senza bicchieri
Buffet set for finger food, w/out glasses
Service à buffet pour finger food, sans verres
Buffet Display für Finger food, ohne Gläser
Servicio para buffet por finger food, sin vasos

cm. 72 x 41 28³/₈" x 16¹/₄"
H cm. 18 H 7¹/₈"

563

560



mm. 1,2 Quadro piano
Square tray
Plateau carré
Tablett, quadratisch
Bandeja cuadrada

cm. 15 x 15 5⁷/₈" x 5⁷/₈"
cm. 22 x 22 8⁵/₈" x 8⁵/₈"



mm. 1,2 Tondo fondo
Round bowl
Bol ronde
Obstschale, rund
Cuenco redondo

Ø cm. 12 cl. 26 Ø 4³/₄" oz. 8³/₄
Ø cm. 15 cl. 60 Ø 5⁷/₈" oz. 20¹/₄
Ø cm. 22 cl. 131 Ø 8⁵/₈" oz. 44¹/₃
Ø cm. 32 lt. 3,0 Ø 12⁵/₈" oz. 101²/₅

B U F F E T



BUFFET





591P



Bicchiere
Glass
Gobelet
Glas
Vaso

H cm 13 H 5"
cl. 45 oz 15 1/4

588P



Bicchiere
Glass
Gobelet
Glas
Vaso

H cm 10 H 3 7/8"
cl. 33 oz. 11 1/8

1131



Mini Forchetta
Appetizer fork
Fourchette amouse
bouche
Minigabel
Mini tenedor

cm. 11,4 4 1/2"

Mini spoon cm. 11,4 4 1/2"

7012



Vassoio per canapé con bicchieri
Canape tray with glasses
Plateau à canape avec verres
Buffet Display mit Gläser
Bandeja para canapé con vasos

8 pz.
cm. 42 x 42

8 pcs
16 1/2" x 16 1/2"

17 pz.
cm. 42 x 72,5

17 pcs
16 1/2" x 28 1/2"

543N



Bicchiere per champagne
Champagne glass
Verre pour Champagne
Champagnerglas
Vaso por champán

H cm. 22,7 H 9"
cl. 15 oz. 5 1/8

555N



Piano per buffet
Tray for buffet
Plateau pour buffet
Buffettablett
Bandeja para buffet

Ø cm. 18 Ø 10 1/2"

543

A Ambra
Amber
Ambre
Amber
Ambar



G Granato
Garnet
Grenat
Granat
Granate



S Smeraldo
Emerald
Emeraude
Smaragd
Esmeralda



Z Zaffiro
Sapphyre
Saphir
Saphir
Zafiro



M Ametista
Amethyst
Amethyste
Amethyst
Amatista



W Trasparente
Transparent
Glace
Transparent
Vidrio



O Onice
Onyx
Onyx
Onyx
Onice



P Porcellana
White
Porcelain
Weiss
Porcelana



N Nero
Black
Noir
Schwarz
Negro



BUFFET

7199



PALACE
Chafing Dish rettangolare con coperchio girevole a 180°
Rectangular Chafing Dish with 180° revolving cover
Chafing Dish rectangulaire avec couvercle basculant à 180°
Chafing Dish rechteckig mit 180° Rollhaube
Chafing Dish rectangular con tapa volvible à 180°

cm. 66 x 45
H cm. 43
Lt. 6,5

26" x 17 3/4"
H 17"
gal. 1 3/4

7199A



cm. 52 x 32
20 1/2" x 12 3/4"

PALACE
Zuppiera per art. 7199
Soup station for art. 7199
Marmite à potage pour art. 7199
Suppenstation für Art. 7199
Sopera para art. 7199

Ø cm. 21,5 Ø 8 1/2"

7201



PALACE
Chafing Dish tondo con coperchio girevole a 180°
Round Chafing Dish with 180° revolving cover
Chafing Dish rond avec couvercle basculant à 180°
Chafing Dish rund mit 180° Rollhaube
Chafing Dish rendono con tapa volvible à 180°

Ø cm. 40
H cm. 46
Lt. 4,5

Ø 15 3/4"
H 18 1/8"
gal. 1 1/4

Ø cm. 38,5 esterno
Ø cm. 22 interno

Ø 15 1/8" outside
Ø 8 3/4" inside

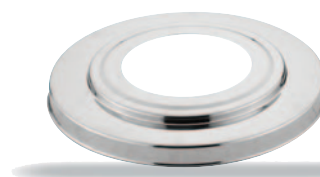

7201A

Ø cm. 21,5 Ø 8 1/2"

PALACE
Zuppiera per art. 7201
Soup station for art. 7201
Marmite à potage pour art. 7201
Suppenstation für Art. 7201
Sopera para art. 7201

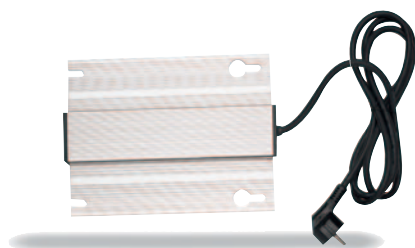

Piastra elettrica per art. 7199
Electric Heater for art. 7199
Element de chauffage électrique pour art. 7199
Heizelement für Art. 7199
Calientador eléctrico para art. 7199

7199B 110V
7199C 220V

cm. 25 x 19
9 3/4" x 7 1/2"

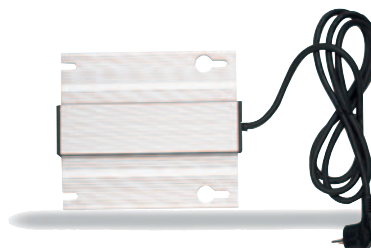

Piastra elettrica per art. 7201
Electric Heater for art. 7201
Element de chauffage électrique pour art. 7201
Heizelement für Art. 7201
Calientador eléctrico para art. 7201

7201B 110V
7201C 220V

cm. 21,5 x 18,5
8 1/2" x 7 1/4"

151



mm. 1,2 Vassoio rettangolare
Rectangular tray
Plateau de presentation
Tablett, rechteckig
Bandeja rectangular

cm. 63 x 45
24 11/16" x 17 3/4"

7204



Coffee Urn	PALACE	Ø cm. 32	gal. 2 ³ / ₄
Coffee Urn	"	H cm. 60	H 23 ⁵ / ₈ "
Bouilleur	"	lt. 11	Ø 12 ⁵ / ₈ "
Kaffeespender	"	Ø cm. 32	Ø 12 ⁵ / ₈ "
Contenedor para café	"	H cm. 67	H 26 ³ / ₈ "
		lt. 19	gal. 5

7206



Distributore per succo di frutta	PALACE	cm. 26 x 35	10 1/4" x 13 3/4"
Juice dispenser	"	H cm. 58	H 22 7/8"
Distributeur à jus	"	lt. 7	gal. 1 7/8
Saftdispenser	"		
Contenedor para zumo de fruta	"		

7208



Doppio distributore per succo di frutta	PALACE	cm. 56 x 35
Double Juice dispenser	"	H cm. 58
Double distributeur à jus	"	lt. 14
Doppel Saftdispenser	"	22" x 13 3/4"
Doble contenedor para zumo de fruta	"	H 22 7/8"
		gal. 3 1/2

HAPPY

10001175



Nuovo sistema per il servizio delle pietanze, per evitare la caduta delle posate all'interno degli chafing. Tutta la collezione HAPPY è a pag. 98.

A new collection of serving pieces designed with a handle that securely rests on the edge of the chafing dish when not in use. The entire Happy collection can be found on page 98.

Nouveau système pour le service des plats, pour éviter la chute des couverts à l'intérieur des chafing. Toute la collection HAPPY est au pag. 98.

"HAPPY" ist eine neue platzsparende Idee, wie man von Chafing Dishes Speisen auf Teller füllen kann, ohne dass die Servierteile hineinfallen. Gesamte HAPPY Kollektion auf Seite 98.

Nuevo sistema por el servicio de las comidas, para evitar la caída de los cubiertos dentro de los chafing. Toda la colección HAPPY es a pag. 98.

Apoggia posate
Knife rest
Soutier p/couverts
Messer bank
Apoyo p/cubiertos

Largh. cm 6,5
Width 2 1/2"

BUFFET

7087



Chafing Dish 1/1 rettangolare con coperchio amovibile cm. 61 x 30 24" x 11 3/4"
 Rectangular Chafing Dish 1/1 with removable cover H cm. 32,5 H 12 3/4"
 Chafing Dish 1/1 rectangulaire avec couvercle démontable lt. 6,5 gal. 1 3/4
 Chafing Dish 1/1 rechteckig mit abnehmbarer Haube
 Chafing Dish 1/1 rectangular con tapa amovible

7086

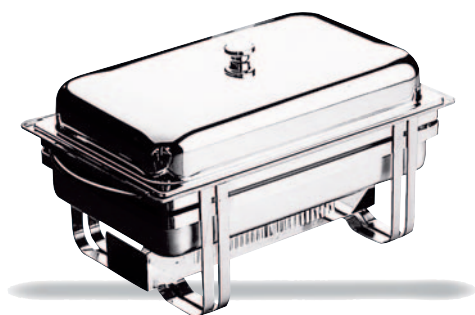

GIOTTO
 Chafing Dish 1/1 rettangolare con coperchio amovibile cm. 61 x 30
 Rectangular Chafing Dish 1/1 with removable cover H cm. 32,5
 Chafing Dish 1/1 rectangulaire avec couvercle démontable lt. 6,5
 Chafing Dish 1/1 rechteckig mit abnehmbarer Haube 24" x 11 3/4"
 Chafing Dish 1/1 rectangular con tapa amovible H 12 3/4"
 gal. 1 3/4

7090



mm. 0,8 Rinfrescatore per yogurt cm. 52,5 x 32,5 20 5/8" x 12 3/4"
 Yogurt cooler lt. 8 gal. 2
 Rafrichisseur à yaourts
 Yoghurtkühler
 Refrigerador para yogurt

236



mm. 1,2 Rinfrescatore per yogurt Ø cm.38
 Yogurt cooler H cm. 9
 Rafrichisseur à yaourts lt. 3,0 Ø 15"
 Yoghurtkühler oz. 101 2/5
 Refrigerador para yogurt

BUFFET



10

22

23

41

42

43

11

16

40S

09

Cucchiaione
 Cooking spoon
 Cuillère à légumes/
 à ragût
 Gemüselöffel
 Cuchara legumbres

Cucchiaio nsalata
 Salad serving
 spoon
 Cuillère à salade
 servir
 Salatvorlegelöffel
 Cuchara servir
 ensalada

Forchetta Insalata
 Salad serving fork
 Fourchette
 à salade servir
 Salatvorlegegabel
 Tenedor servir
 ensalada

Cucchiaione
 con fori
 Serving spoon
 w/holes
 Cuillère a/trous
 Servierlöffel
 m/Löchern
 Cuchara
 c/agujeros

Cucchiaione
 con asole
 Serving spoon
 w/slots
 Cuillère a/oieilles
 Servierlöffel
 m/Ösen
 Cuchara
 c/ojales

Cucchiaio risotto
 "Risotto" spoon
 Cuillère "Risotto"
 Reislöffel
 Cuchara arroz seco

Forchettone a servire
 Serving fork
 Fourchette à légumes/
 à servir
 Fleischgabel
 Tenedor legumbres

Pala per Torta
 Cake trowel
 Pelle à tarte
 Tortenheber
 Pala tarta

Mestolo a servire
 Ladle
 Louche
 Suppenschöpfer
 Cazo Sopa

10201109

10201110

10201122

10201123

10201141

10201142

10201143

10201111

10201116

10201140S

7999

7999



"MATHUSALEM"
lt. 6 - gal. 1 1/2

"SALMANAZAR"
lt. 9 - gal. 2 1/2

Culla portachampagne "MATHUSALEM" lt. 6 - gal. 1 1/2
 Champagne holder "SALMANAZAR" lt. 9 - gal. 2 1/2
 Porte-champagne
 Champagnerflaschenhalter cm 45 x 31 - H cm 65
 Portabotella de champagne 17 3/4" x 12 1/4" - H 25 1/2"





Yogurt



Miele



Palace

964



mm. 1,2 Vassoio rettangolare con maniglie
Rectangular Tray with handles
Plateau rectangulaire avec anses
Tablett rechteckig mit Griffen
Bandeja rectangular con asas

cm. 40x27 15³/₄" x 10⁵/₈"
cm. 45x31 17³/₄" x 12¹/₄"
cm. 50x34 19⁵/₈" x 13³/₈"
cm. 60x42 23⁵/₈" x 16¹/₈"

963GN



mm. 1,2 Vassoio rettangolare gastronomico
Rectangular gastronomic Tray
Plateau rectangulaire gastronomico
Tablett rechteckig gastronomico
Bandeja rectangular gastronomico

cm. 53 x 32,5 20³/₄" x 12²/₃"

963



mm. 1,2 Vassoio rettangolare
Rectangular Tray
Plateau rectangulaire
Tablett rechteckig
Bandeja rectangular

cm. 30x21 11³/₄" x 8¹/₄"
cm. 35x24 13³/₄" x 9¹/₂"
cm. 40x27 15³/₄" x 10⁵/₈"
cm. 45x31 17³/₄" x 12¹/₄"
cm. 50x34 19⁵/₈" x 13³/₈"
cm. 60x42 23⁵/₈" x 16¹/₈"

966



mm. 1,2 Vassoio tondo
Round Tray
Plateau rond
Tablett rund
Bandeja redonda

Ø cm. 13 5 1/8"
Ø cm. 19 7 1/2"
Ø cm. 24 9 1/2"
Ø cm. 27 10 5/8"
Ø cm. 35 13 3/4"
Ø cm. 40 15 3/4"

965



mm. 1,2 Vassoio rettangolare con piedini
Rectangular Tray with feet
Plateau rectangulaire avec socles
Tablett rechteckig mit Füßen
Bandeja rectangular con 4 pies

cm. 30x21 11³/₄" x 8¹/₄"
cm. 35x24 13³/₄" x 9¹/₂"
cm. 40x27 15³/₄" x 10⁵/₈"
cm. 45x31 17³/₄" x 12¹/₄"
cm. 50x34 19⁵/₈" x 13³/₈"
cm. 60x42 23⁵/₈" x 16¹/₈"

967



mm. 1,2 Vassoio tondo con piedini
Round Tray with feet
Plateau rond avec socles
Tablett rund mit Füßen
Bandeja redonda con 4 pies

Ø cm. 27 10 5/8"
Ø cm. 35 13 3/4"
Ø cm. 40 15 3/4"

950



mm. 1,2	Ciotola con base	Ø cm. 14	cl. 60	Ø 5 1/2"	oz. 20 1/4
	Bowl with base	H cm. 8,8		H 3 1/2"	
	Bol avec socle	Ø cm. 20	lt. 1,8	Ø 7 7/8"	oz. 60 7/8
	Obstschale auf Fuss	H cm. 11		H 4 1/2"	
	Cuenco con pedestal	Ø cm. 24	lt. 3,1	Ø 9 1/2"	oz. 104 7/8
		H cm. 14		H 5 1/2"	
		lt. 5,1	Ø 11"	gal. 1 1/4	
		H cm 16	H 6 1/3"		

977



mm. 1,2	Porta pasticcini	Ø cm 13	Ø 5 1/8"
	Petit-fours stand	H cm 10,5	H 4 1/8"
	Porte-petit fours		
	Petits Fours-Ständer	Ø cm 19	Ø 7 1/2"
	Porta dulces	H cm 14	H 5 1/2"

981A



mm. 1,2	Alzata portafrutta rettang. 2 piani	cm 35x24	13 3/4" x 9 1/2"
	Rectangular fruit holder 2 layers	cm 45x31	17 3/4" x 12 1/4"
	Serviteur rectangulaire 2 etages	H cm 50	H 19 5/8"
	Etagere, rechteckig 2-stufig		
	Frutero rectangular 2 pisos		

981B



mm. 1,2	Alzata portafrutta rettang. 3 piani	cm 35x24	13 3/4" x 9 1/2"
	Rectangular fruit holder 3 layers	cm 45x31	17 3/4" x 12 1/4"
	Serviteur rectangulaire 3 etages	cm 60x42	25 5/8" x 16 1/8"
	Etagere, rechteckig 3-stufig	H cm 73	H 28 3/4"
	Frutero rectangular 3 pisos		

978



mm. 1,2 Porta pasticcini a 2 piani
Petit-fours stand 2 layers
Porte-petit fours 2 etages
Mokkaétagère 2 Ebenen
Porta dulces 2 pisos

Ø cm. 13	Ø 5 1/8"
Ø cm. 19	Ø 7 1/2"
H cm. 29	H 11 3/8"

97803



mm. 1,2 Porta pasticcini a 3 piani
Petit-fours stand 3 layers
Porte-petit fours 3 etages
Mokkaétagère 3 Ebenen
Porta dulces 3 pisos

Ø cm 13	Ø 5 1/8"
Ø cm 19	Ø 7 1/2"
Ø cm 27	Ø 10 3/8"
H cm 36	H 14 1/4"

980B



mm. 1,2 Alzata portafrutta tonda 3 piani
Round fruit holder 3 layers
Serviteur rond 3 etages
Etager, rund 3-stufig
Frutero redondo 3 pisos

Ø cm 27	Ø 10 5/8"
Ø cm 35	Ø 13 3/4"
Ø cm 40	Ø 15 3/4"
H cm 73	H 28 3/4"

980A



mm. 1,2 Alzata portafrutta tonda 2 piani
Round fruit holder 2 layers
Serviteur rond 2 etages
Etager, rund 2-stufig
Frutero redondo 2 pisos

Ø cm 27	Ø 10 5/8"
Ø cm 35	Ø 13 3/4"
H cm 50	H 19 5/8"

928



mm. 1,2 Vassoio rettangolare da servizio
 Rectangular service tray
 Plateau rectangulaire pour service
 Tablett rechteckig für Service
 Bandeja rectangular da servicio

cm. 30x21	11 ³ / ₄ " x 8 ¹ / ₄ "
cm. 35x24	13 ³ / ₄ " x 9 ¹ / ₂ "
cm. 40x27	15 ³ / ₄ " x 10 ⁵ / ₈ "
cm. 45x31	17 ³ / ₄ " x 12 ¹ / ₄ "
cm. 50x34	19 ⁵ / ₈ " x 13 ³ / ₈ "
cm. 60x42	23 ⁵ / ₈ " x 16 ¹ / ₈ "

927



mm. 1,2 Vassoio tondo da servizio
 Round service tray
 Plateau rond pour service
 Tablett rund für Service
 Bandeja redonda por servicio

Ø cm. 27	Ø 10 ⁵ / ₈ "
Ø cm. 35	Ø 13 ³ / ₄ "
Ø cm. 40	Ø 15 ³ / ₄ "

959



Coppa in vetro c/piedistallo
 Glass bowl with base
 Coupe ronde en verre a/socle
 Glassobstschale rund auf Fuß
 Cuenco redondo en vidrio c/pedestal

959
 Ø cm 21,5
 H cm 29
 cl. 270

960
 Ø cm 12
 H cm 17
 cl. 45

960



959
 Ø 8¹/₂"
 H 11³/₈"
 oz. 91³/₈

960
 Ø 4³/₄"
 H 6³/₄"
 oz. 15¹/₄

962



Piatto da torta in vetro c/piedistallo
 Glass cake plate with base
 Plat pour gateau en verre a/socle
 Kuchenplatte aus Glas auf Fuss
 Plato para tarta en vidrio c/pedestal

Ø cm 33
 H cm 16
 Ø 12³/₄"
 H 6¹/₄"

958



Coppa multiservizio
 Glass bowl with sauce cap
 Coupe multifonctions
 Universalschale
 Ensaladera multiservicio

Ø cm 28
 H cm. 14
 cl. 300
 Ø 11"
 H 5¹/₂"
 oz. 101¹/₂

938



mm. 1,2 Vassoio ovale
 Oval tray
 Plateau oval
 Tablett oval
 Bandeja oval

cm. 31 x 22 12¹/₈" x 8³/₄"

937



mm. 1,2 Cestino per pane
 Oval basket
 Corbeille oval
 Brotkorb oval
 Frutero oval

cm. 31 x 22 12¹/₈" x 8³/₄"
 lt. 1,7 oz. 57¹/₂

968



970

mm. 2,0 Ampolla e formaggera
Cruet and cheese basin
Huillière et fromagère
Essig-Ölflasche und Käsedose
Vinagrera y quesera

cl. 22 H cm 15
oz. 7 1/2 H 5 7/8"

cl. 20
oz. 6 3/4

969



971

mm. 2,0 Salino e porta stuzzicadenti
Salt-cellar and toothpick container
Salière et porte cure-dents
Salzstreuer und Zahnstocherbehälter
Salero y palillero

cl. 8 H cm. 9
oz. 2 3/4 H 3 1/2"

cl. 7 H cm 7
oz. 2 3/8 H 2 3/4"

975



mm. 1,2 Chillcup
Caviar dish
Bol à caviar
Chillcup / Kaviarschale
Bol para caviar

cl. 15 H cm 19
oz. 5 1/8 Ø 7 1/2"

mm. 1,2 Servizio per antipasto
Snack server
Support à snacks
Relish-Pickles-Gestell
Entremesera

Ø cm. 20 H cm 15
cl. 15 (x3) oz. 5 1/8 (x3)

Ø 7 7/8" H 5 7/8"

976

935



mm. 1,2 Porta macaron
Macarons server
Porte macarons
Macaronsträger
Porta macaron

Ø cm 15 H cm 10
Ø 5 7/8" H 4"

976S

976C



mm. 1,2 Portasalatini impilabile
Stackable snack server
Support à snack empilable
Stapelbare Relish-Pickles-Gestell
Servicio por entremes impilable

Ø cm. 20 H cm 15
cl. 15 (x3)

Ø 7 7/8" H 5 7/8"

Ø 7 7/8" H 5 7/8"

oz. 5 1/8 (x3)

oz. 5 1/8 (x3)

951



mm. 1,2 Caffettiera con piedistallo
Coffee pot with base
Cafetière avec socle
Kaffekanne auf Fuss
Cafetera con pedestal

Tazze	4	cl 34	oz 12 ¹ / ₃
Cups	6	cl 52	oz 17 ² / ₃
Bols			
Tassen			
Tazas			

952



mm. 1,2 Teiera con piedistallo
Tea pot with base
Théière avec socle
Teekanne auf Fuss
Tetera con pedestal

Tazze	2	cl 37	oz 13
Cups	6	cl 60	oz 21
Bols			
Tassen			
Tazas			

953



mm. 1,2 Lattiera con piedistallo
Milk jug with base
Pot à lait avec socle
Milchkanne auf Fuss
Jarra lechera con pedestal

Tazze	2	cl 24	oz 8
Cups	4	cl 34	oz 12 ¹ / ₃
Bols			
Tassen			
Tazas			

954



mm. 1,2 Zuccheriera con piedistallo
Sugar bowl with base
Sucrier avec socle
Zuckerdose auf Fuss
Azucarero con pedestal

Tazze	6	cl 27	oz 10
Cups			
Bols			
Tassen			
Tazas			

957



mm. 1,2 Portabustine da zucchero
Sugar packet holder
Pot à sucre
Zuckerstangengefäß
Azucarera

Ø cm 7	H cm 9,5
Ø 2 ³ / ₄ "	H 3 ³ / ₄ "

914



mm. 1,2 Vassoietto
Tray
Plateau
Tablett
Bandeja

cm. 13 x 7
5 ¹/₉" x 2 ³/₄"

982



mm. 1,2 Alzata portafrutta
Fruit holder
Serveur
Obstschale
Frutero

Ø cm 27	H cm. 15
Ø 10 ⁵ / ₈ "	H 5 ⁷ / ₈ "

247

247



Ø cm*	Ø in*
7,5	3"
10	4"
10,5	4 1/16"
13	5 1/16"
14	5 1/2"
14,5	5 5/7"
20	7 7/8"
22	8 5/8"
24	9 1/2"
26	10 1/4"
28	11"
30	11 3/4"
31	12 1/8"
32	12 5/8"
33	13"

mm. 0,8 Cloche con pomolo
Cloche with knob
Cloche
Teller cloche
Tapa con pomo

* Tabella diametri misurati al bordo del piatto
* Table of diameters, measured at the edge of the plate

984

974

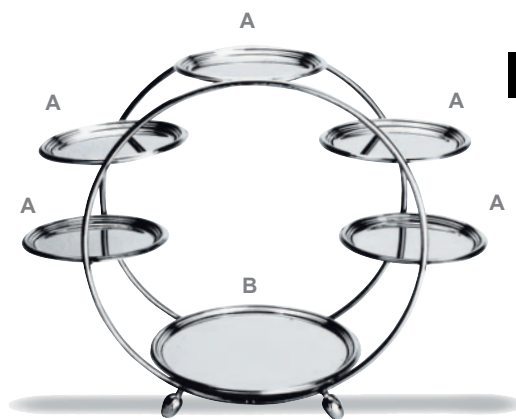
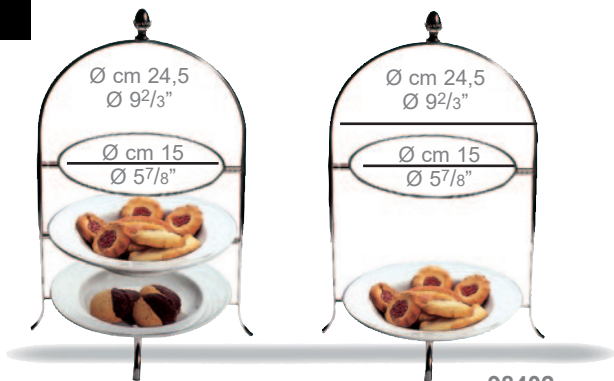

	984	984	98402	
Alzata portapiatti	Ø cm 24	Ø 9 1/2"	Ø cm 24	Ø 9 1/2"
Afternoon tea stand	H cm.43	H 16 7/8"	H cm.43	H 16 7/8"
Présentoir à gateau	985	985		
Dessert-Serviergestell	Ø cm 21	Ø 8 1/4"		
Soporte platos	H cm.37	H 14 1/2"		
	989	989		
	Ø cm 30	Ø 11 3/4"		
	H cm.50,5	H 19 7/8"		

mm. 1,2 Presentoire
2 misure
2 sizes
2 tailles
2 Größen
2 tamaños

A Ø cm.13 (x5)	A Ø 5 1/8" (x5)
B Ø cm.19	B Ø 7 1/2"
A Ø cm.19 (x5)	A Ø 7 1/2" (x5)
B Ø cm.27	B Ø 10 5/8"

7092

7094



7092
Candelabro a 1 fiamma Silverplated
Candlestick H cm. 28,5
Chandelier
Leuchter 1-flammig H 11 1/4"
Candelabro

7093
Candelabro a 3 fiamme Silverplated
Candelabra, 3 arms H cm. 34,5
Chandelier 3 flammes
Leuchter 3-flammig H 13 5/8"
Candelabro 3 luces

7094
Candelabro a 5 fiamme Silverplated
Candelabra, 5 arms H cm. 34,5
Chandelier 5 flammes
Leuchter 5-flammig H 13 5/8"
Candelabro 5 luces

972

973



972

973

973P

972P

mm. 1,2
972-972P
 Secchiello per ghiaccio
 Ice bucket
 Seau à glaçons
 Eisgefäß
 Cubitera hielo

Ø cm 15 Ø 5 7/8"
 H cm 18 H 7 1/8"
 cl.150 oz. 50 3/4

mm. 1,2
973-973P
 Secchiello per spumante
 Sparkling wine cooler
 Seau à champagne
 Wein- und Sektkühler
 Cubo para champany

Ø cm 20,5 Ø 8 1/8"
 H cm 24,5 H 9 5/8"
 cl.500 gal. 1 1/3

666F

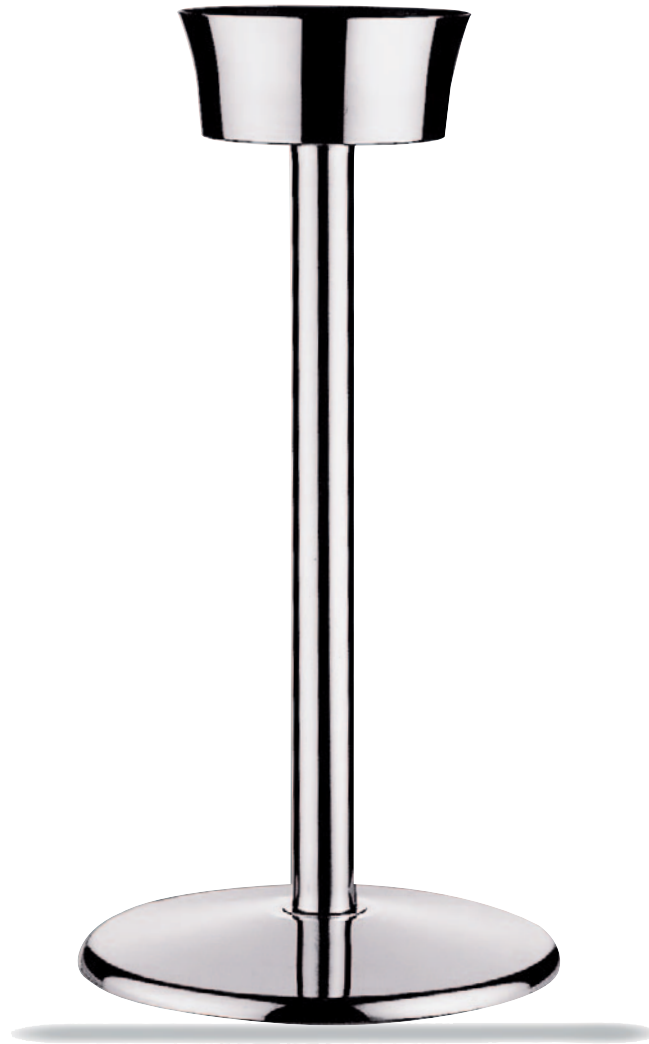

mm. 1,2
 Colonna portasecchiello spumante
 Wine cooler stand w/weighted base
 Pied pour seau à champagne
 Weinkühlerständer
 Columna porta cubo champany

H cm. 67,5 H 26 5/8"

657



mm. 0,8 Coppa per champagne con inserto
Champagne bowl with insert
Vasque a champagne avec anneau porte-verre
Champagner Bowl mit Gläser - Flaschenring
Copa para champagne con anillo

Ø cm. 38 Ø 15"
H cm. 29,5 H 11 5/8"
lt. 15 gal. 4

949



mm. 1,2 Supporto per informazioni o menu
Menu / Card holder
Porte nom numéro de table
Karten-Speisekartenhalter
Porta informaciones o menu

Ø cm. 10 Ø 4"
H cm. 10 H 4"

986



mm. 0,8 Alzata per crudité rettangolare
Rectangular seafood presentation
Serviteur à poisson crude rectang.
Etagere, rech., für marinierte Fisch
Porta pescado rectangular

cm. 53 x 32,5 20 3/4" x 12 2/3"
H cm. 9 H 3 1/2"
lt. 9,0 gal. 2

mm. 2,0 Portanumero
Table number stand
Numbers etched to order
Porte numéro de table
Tischnummernständer
Porta numero de mesa

A
Ø cm 13 Ø 5 1/8"
H cm 54 H 21 1/4"

B
Ø cm 13 Ø 5 1/8"
H cm 30 H 11 7/8"

995



987



mm. 0,8 Alzata per crudité rettangolare
Elevated rectangular seafood
presentation
Serviteur à poisson crude rectang.
Etagere, rech., für marinierte Fisch
Porta pescado rectangular

cm. 53 x 32,5 20 3/4" x 12 2/3"
H cm. 25,8 H 10 1/7"
lt. 9,0 gal. 2

253



mm. 0,8 Rinfrescatore con piedini
Yogurt cooler with feet
Rafrachisseur à yaourts a/socles
Yoghurtkühler mit Füßen
Refrigerador para yogurt con pies

Ø cm 35 Ø 13 3/4"
H cm. 12 H 4 3/4"
lt. 2,0 oz. 67 3/5

983

944



mm. 1,2 Zuppiera
 Soup tureen
 Soupière
 Suppenterrine
 Sopera

Ø cm. 14 - lt. 0,6	Ø 5 1/2" - oz. 20 1/4
Ø cm. 18 - lt. 1,2	Ø 7" - oz. 40 5/8
Ø cm. 20 - lt. 1,8	Ø 7 7/8" - oz. 60 7/8
Ø cm. 22 - lt. 2,5	Ø 8 5/8" - oz. 84 1/2
Ø cm. 24 - lt. 3,1	Ø 9 1/2" - oz. 104 7/8
Ø cm. 26 - lt. 3,9	Ø 10 1/4" - oz. 131 7/8
Ø cm. 28 - lt. 5,1	Ø 11" - gal. 1 1/4

945



mm. 1,2 Legumiera
 Vegetable dish
 Légumière
 Lègumier
 Legumbrera

Ø cm. 14 - lt. 0,6	Ø 5 1/2" - oz. 20 1/4
Ø cm. 18 - lt. 1,2	Ø 7" - oz. 40 5/8
Ø cm. 20 - lt. 1,8	Ø 7 7/8" - oz. 60 7/8
Ø cm. 22 - lt. 2,5	Ø 8 5/8" - oz. 84 1/2
Ø cm. 24 - lt. 3,1	Ø 9 1/2" - oz. 104 7/8
Ø cm. 26 - lt. 3,9	Ø 10 1/4" - oz. 131 7/8
Ø cm. 28 - lt. 5,1	Ø 11" - gal. 1 1/4

946



mm. 1,2 Coperchio per art. 944 - 945
 Lid for art. 944 - 945
 Couvercle pour art. 944 - 945
 Deckel für art. 944 - 945
 Tapa para art. 944 - 945

Ø cm. 14	Ø 5 1/2"
Ø cm. 18	Ø 7"
Ø cm. 20	Ø 7 7/8"
Ø cm. 22	Ø 8 5/8"
Ø cm. 24	Ø 9 1/2"
Ø cm. 26	Ø 10 1/4"
Ø cm. 28	Ø 11"

936



Cloche trasparente con pomolo
 Transparent cloche with knob
 Cloche transparente
 Transparent Teller cloche
 Tapa transparente

Ø cm. 12	Ø 4 3/4"
Ø cm. 22	Ø 8 1/2"
Ø cm. 28	Ø 11"

940



mm. 1,2 Servizio per caffè macchiato
 Café au lait set
 Service pour café au lait
 Café au lait-Set
 Juego café au lait

939
 H cm 18
 cl. 90

940
 H cm 18
 cl. 97

939
 H 7 1/8"
 oz. 30 1/2

940
 H 7 1/8"
 oz. 32 7/8

940E
 Inserto per art. 940
 Insert for art. 940
 Insért pour art. 940
 Einsatz für Art. 940
 Inserto por art. 940

940E



mm. 1,2 Servizio per caffè macchiato
 5pcs Sugar, milk and coffee set
 Service sucre, lait et café 5 pièces
 Milch-Kaffee-Zucker Set 5-Tlg.
 Juego leche, café y azucar 5 piezas

H cm 18	H 7 1/8"
cl. 30 (x5)	oz. 10 1/8 (x5)

94005



943



mm. 1,2 Spargisale, portastecchi
Salt & Pepper
Sel/poivre/porte cure-dents
Salz-Pfeffer-Zahnstocherbehälter
Saleros y pimentero y palillero

H cm. 15 H 5 7/8"
cl. 7,5 (x 2) oz. 2 1/2 (x 2)

942



mm. 1,2 Oliera
Cruet
2 pièces huile-vinaigre
Essig-/Ölgestell
Vinagreras

H cm. 22 H 8 5/8"
cl. 22,5 (x 2) oz. 7 1/2 (x 2)

988



mm 1,2 Portamarmellata a 3 scomparti
Jam pack holder 3 compartment
Porte-confiture 3 comp.
Marmeladgestell 3 Einsätze
Marmeladero 3 comp.

H. cm. 15 H 5 7/8"
cl. 28 (x3) oz. 9 1/2 (x3)

990



mm 1,2 Coppetta con vassoio
Cup and tray
Coupe avec plateau
Schale mit Tablett
Cuenco con bandeja

H cm. 11,5 H 4 1/2"
Ø cm. 10 Ø 3 7/8"

947



Versatore per profumo a goccia
Perfume drops dispenser
Verseur de parfum en gouttes
Tropf-Parfüm Aussteller
Versador de perfume en gotas

Lungh. cm 18,5
Length 7 5/8"

94003



mm. 1,2 Servizio per zucchero 3 e 4 pezzi
Sugar set 3 and 4 pcs.
Service pour sucre 3 et 4 pièces
Sahne-/Zucker-Set 3- und 4-Tlg
Juego azucar 3 y 4 piezas

H cm. 15 H 5 7/8"
cl. 11 (x3) oz. 3 3/4 (x3)
cl. 11 (x4) oz. 3 3/4 (x4)

94004



mm. 1,2 Mini burriera con coperchio
Small butter dish w/lid
Petit beurrier a/couvercle
Mini Butterdose m/Deckel
Platillo para mantequilla
con tapa

cm. 12 x 6 4 3/4" x 2 1/3"
cl. 15 oz. 5 1/8

922



Giotto

257



mm. 1,2 Porta pasticcini con piedistallo
Petit-fours stand with base
Porte-petits-fours avec socle
Petits Fours-Ständer
Porta dulces con pedestal

Ø cm. 14	Ø 5 1/2"
H cm. 8,7	H 3 1/2"
Ø cm. 20	Ø 7 7/8"
H cm. 13	H 5 1/8"
Ø cm. 28	Ø 11"
H cm. 14,5	H 5 3/4"

258



mm. 1,2 Porta pasticcini con piedistallo
Petit-fours stand with legs
Porte-petits-fours avec socle
Mokkaétagère 3 Ebenen
Porta dulces con pedestal

Ø cm. 14	Ø 5 1/2"
Ø cm. 20	Ø 7 7/8"
Ø cm. 28	Ø 11"
H cm. 27	H 10 5/8"

220



mm. 1,2 Coppa per punch
Punch bowl
Bol à punch
Punch Bowl
Ponchera

Ø cm. 38	Ø 15"
H cm. 32,3	H 12 5/7"
lt. 15	gal. 4

255



mm. 1,2 Presentoire
3 misure
3 sizes
3 tailles
3 Größen
3 tamaños

25514	25514
A Ø cm.14 (x5)	A Ø 5 1/2" (x5)
B Ø cm.20	B Ø 7 7/8" (x5)
25520	25520
A Ø cm.20 (x5)	A Ø 7 7/8" (x5)
B Ø cm.24	B Ø 9 1/2" (x5)
25524	25524
A Ø cm.24 (x5)	A Ø 9 1/2" (x5)
B Ø cm.28	B Ø 11"

7070

7073



7071

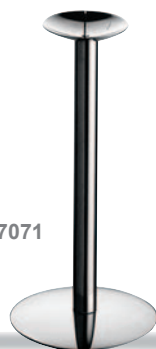

7072



7073



Candelabro bugia Candlestick Chandelier Leuchter mit Kerze Candelabro	H cm. 13 H 5 1/8"	Candelabro a 1 fiamma Candlestick Chandelier Leuchter 1-flammig Candelabro	H cm. 23,6 H 9 1/4"	Candelabro a 3 fiamme Candelabra, 3 arms Chandelier 3 flammes Leuchter 3-flammig Candelabro 3 luces	H cm. 23,6 H 9 1/4"	Candelabro a 5 fiamme Candelabra, 5 arms Chandelier 5 flammes Leuchter 5-flammig Candelabro 5 luces	H cm. 23,6 H 9 1/4"
---	----------------------	--	------------------------	---	------------------------	---	------------------------

141



mm. 1,2 NOVECENTO
Vassoio
Tray
Plateau
Tablett
Bandeja

cm. 30 x 21	11 3/4" x 8 1/4"
cm. 35 x 24	13 3/4" x 9 1/2"
cm. 40 x 27	15 3/4" x 10 5/8"
cm. 45 x 31	17 3/4" x 12 1/4"
cm. 50 x 34	19 5/8" x 13 3/8"
cm. 60 x 42	23 5/8" x 16 1/2"
cm. 80 x 54	31 1/2" x 21 1/4"

144



mm. 1,2 NOVECENTO
Vassoio con maniglie
Tray with handles
Plateau avec anses
Tablett mit Griffen
Bandeja con asas

cm. 40 x 27	15 3/4" x 10 5/8"
cm. 45 x 31	17 3/4" x 12 1/4"
cm. 50 x 34	19 5/8" x 13 3/8"
cm. 60 x 42	23 5/8" x 16 1/2"
cm. 80 x 54	31 1/2" x 21 1/4"

141GN



mm. 1,2 NOVECENTO
Gastronorm

1/1 GN	1/1 GN
cm. 53 x 32,5	20 7/8" x 12 2/3"

2/1 GN2	2/1 GN2
cm. 65 x 53	25 5/8" x 20 7/8"

144GN



mm. 1,2 NOVECENTO
Gastronorm con maniglie
Gastronorm with handles
Gastronorm avec anses
Gastronorm mit Griffen
Gastronorm con asas

1/1 GN
cm. 53 x 32,5
20 7/8" x 12 2/3"

2/1 GN2
cm. 65 x 53
25 5/8" x 20 7/8"

146GN



mm. 1,2 NOVECENTO
Gastronorm

1/1 GN	1/1 GN
cm. 53 x 32,5	20 7/8" x 12 2/3"

2/1 GN2	2/1 GN2
cm. 65 x 53	25 5/8" x 20 7/8"

146



mm. 1,2 Vassoio con maniglia sovrapponibile
Tray with stackable handles
Plateau avec anses empilables
Tablett mit stapelbaren Griffen
Bandeja con asas empilables

cm. 30 x 21	11 3/4" x 8 1/4"
cm. 35 x 24	13 3/4" x 9 1/2"
cm. 40 x 27	15 3/4" x 10 5/8"
cm. 45 x 31	17 3/4" x 12 1/4"
cm. 50 x 34	19 5/8" x 13 3/8"
cm. 60 x 42	23 5/8" x 16 1/2"
cm. 80 x 54	31 1/2" x 21 1/4"

137



mm. 1,2 Vassoio quadro NOVECENTO cm. 60 x 60 23 5/8" x 23 5/8"
 Square tray »
 Plateau carré »
 Tablett, quadratisch »
 Bandeja cuadrada »

256



mm. 1,2 Vassoio rotondo GIOTTO Ø cm. 27 Ø 10 5/8"
 Round tray » Ø cm. 35 Ø 13 3/4"
 Plateau rond » Ø cm. 40 Ø 15 3/4"
 Tablett rund »
 Bandeja redonda »

138



mm. 1,2 Vassoio quadro con maniglie NOVECENTO cm. 60 x 60 23 5/8"x23 5/8"
 Square tray with handles »
 Plateau carré avec anses »
 Tablett, quadratisch mit Griffen »
 Bandeja cuadrada con asas »

AIRLINES

140



mm. 1,2 Vassoio per compagnie aeree 200140 ATLAS
 Airlines tray for on board service cm. 38,5 x 27,5
 Ideal for aircraft and corporates jets 15 1/8" x 10 4/5"
 Chariot de service 200140K KSSU
 Bordservice -Tablett f. Airlines cm. 40,4 x 27,9
 Bandeja de servicio para comp. aéreas 15 7/8" x 11"

139



mm. 1,2 Vassoio quadr.c/man.sovrappon. cm. 60 x 60 23 5/8" x 23 5/8"
 Square tray w/stackable handles
 Plateau carré a/anses empliabiles
 Tablett quadr.m/stapelb. Griffen
 Bandeja cuadrada c/asas empil.

250

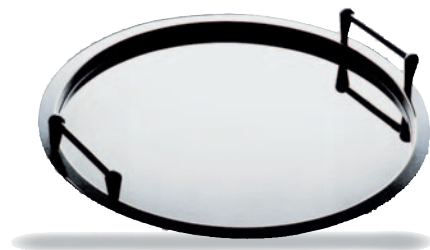

mm. 1,2 Vassoio con maniglia sovrapponibile Ø cm. 35 Ø 13 3/4"
 Tray with stackable handles Ø cm. 40 Ø 15 3/4"
 Plateau avec anses empliabiles
 Tablett mit stapelbaren Griffen
 Bandeja con asas empilables

295



mm. 1,2 Vassoio tondo con piedistallo Ø cm. 35 Ø 13 3/4"
 Round tray with base H cm. 12,5 H 4 7/8"
 Plateau rond avec socle
 Obstschale, rund auf Fuß
 Bandeja redonda con pedestal

297



mm. 1,2 Vassoio ovale con piedistallo cm. 45 x 30 17 3/4" x 11 3/4"
 Oval tray with base H cm. 12,5 H 4 7/8"
 Plateau oval avec socle
 Obstschale, oval auf Fuß
 Bandeja oval con pedestal

296



mm. 1,2 Vassoio rettang. con piedistallo cm. 45 x 30 17 3/4" x 11 3/4"
 Rectangular tray with base H cm. 12,5 H 4 7/8"
 Plateau rectang. avec socle
 Tablett, rechteckig auf Fuß
 Bandeja rectang. con pedestal

298



mm. 1,2 Piatto torta con piedistallo Ø cm. 40 Ø 15 3/4"
 Cakes plate with base H cm. 9,5 H 3 3/4"
 Plat à tarte avec socle
 Kuchenplatte auf Fuß
 Bandeja tarta con pedestal

287



mm. 2,0 Vassoio rettangolare per buffet cm. 30x21 11 3/4" x 8 1/4"
 Rectangular Tray for buffet cm. 40x27 15 3/4" x 10 5/8"
 Plateau rectangulaire pour buffet cm. 50x34 19 5/8" x 13 3/8"
 Buffet -Tablett, rechteckig cm. 60x42 23 5/8" x 16 1/8"
 Bandeja rectangular para entremes

288



mm. 2,0 Vassoio tondo per buffet Ø cm. 30 Ø 11 3/4"
 Round Tray for buffet Ø cm. 40 Ø 15 3/4"
 Plateau rond pour buffet Ø cm. 50 Ø 19 5/8"
 Buffet-Tablett rund Ø cm. 60 Ø 23 5/8"
 Bandeja redonda para entremes

7004A



mm. 0,8 Alzata per pesce crudo
Marinated fish holder
Serviteur à poisson crude
Etagere für marinierten Fisch
Porta pescado

Ø cm. 34 Ø 13 3/4"
Ø cm. 41 Ø 16 1/8"
H cm. 55 H 21 5/8"

7004B



mm. 1,2 Alzata per pesce crudo
Marinated fish holder
Serviteur à poisson crude
Etagere für marinierten Fisch
Porta pescado

Ø cm. 22 Ø 8 5/8"
Ø cm. 34 Ø 13 3/8"
H cm. 38 H 15"

7002B



mm. 1,2 Alzata portafrutta
Fruit holder
Serviteur
Etagere
Frutero

NOVECENTO »
»
»
»

cm. 35x24 13 3/4" x 9 1/2"
cm. 45x31 17 3/4" x 12 1/4"
cm. 60x42 23 5/8" x 16 1/2"
H cm. 70 H 27 5/8"

7001B



mm. 1,2 Alzata portafrutta
Fruit holder
Serviteur
Etagere
Frutero

GIOTTO »
»
»
»

Ø cm. 27 Ø 10 5/8"
Ø cm. 35 Ø 13 3/4"
Ø cm. 40 Ø 15 3/4"
H cm. 70 H 27 5/8"

67301



67304

mm. 1,2 Portaggiaccio termico con coperchio Ø cm 14 Ø 5 1/2"
 Insulated ice-bucket with lid H cm 13,5 H 5 1/9"
 Seau à glaçons thermique avec couvercle lt. 0,70 oz. 23 2/3
 Isolier-Eisgefäß, mit Deckel Ø cm 24 Ø 9 1/2"
 Cubitera hielo térmica con tapa H cm 23 H 9"
 lt. 2,75 oz. 93

668



669

mm. 1,2 Secchiello spumante e ghiaccio Ø cm 24 Ø 9 1/2"
 Sparkling wine cooler / Ice bucket H cm 23 H 9"
 Seau à champagne et à glaçons lt. 2,75 oz. 93
 Wein- Sektkühler / Eisgefäß Ø cm 14 Ø 5 2/3"
 Cubo para champany y para hielo H cm 13,5 H 5 1/9"
 lt. 0,70 oz. 23 2/3

666E



mm. 1,2 Colonna portasecchiello spumante H cm. 67,5 H 26 5/8"
 Wine cooler stand
 Pied pour seau à champagne
 Weinkühlerständer
 Columna porta cubo champany

686



mm. 1,2 Champagnera 5 bott. c/pied. Ø cm. 40 Ø 15 3/4"
 Giant Champagne bucket 5 bot. H cm. 38,5 H 15 1/6"
 Seau à champagne p/5 bout. lt. 15 gal. 4
 Champagner Bowl 5 Fläsche
 Cubo de champagne p/5 bot.

685



mm. 1,2 Champagnera 5 bott. s/pied. Ø cm. 40 Ø 15 3/4"
 Giant Champagne bucket 5 bot. H cm. 21,8 H 8 3/5"
 Seau à champagne p/5 bout. lt. 15 gal. 4
 Champagner Bowl 5 Fläsche
 Cubo de champagne p/5 bot.

666I



mm. 1,2 Colonna portabottiglie spumante H cm. 78 H 30 5/7"
 Wine cooler stand
 Pied pour seau à champagne
 Weinkühlerständer
 Columna porta cubo champany

674



mm. 1,2 Spumantiera termica 5 bott. s/pied. Ø cm. 40 Ø 15 3/4"
 Giant insulated Champagne bucket 5b. H cm. 21,8 H 8 3/5"
 Seau à champagne thermique p/5 bou. lt. 15 gal. 4
 Isolier Champagner Bowl 5 Fläsche
 Cubo térmico para champagne p/5 bot.

265



mm. 1,2 Vassoio per pasticceria
Patisserie tray
Plateau pour patisserie
Patisserie Tablett
Bandeja para pasteleria

cm. 24,5 x 17 9 5/8" x 6 3/4"
cm. 30 x 21 11 3/4" x 8 1/4"
cm. 34 x 24 13 3/8" x 9 1/2"

NEW

207



con piedistallo
with foot
avec socle
mit Fuss
con pies

cm. 24,5 x 17 9 5/8" x 6 3/4"
cm. 30 x 21 11 3/4" x 8 1/4"
cm. 34 x 24 13 3/8" x 9 1/2"
H cm. 13 H 5 1/9"

516



516



51610

mm. 1,2 Portabustine da zucchero
Sugar packet holder
Pot à sucre
Zuckerstangengefäß
Azucarera

516
cm. 10 x 7
H cm. 3
516
4" x 2 3/4"
H 1 1/8"

51610
cm. 10 x 5
H cm. 4,5
51610
4" x 2"
H 1 3/4"



518

Cesto portapane, porta agrumi
Basket for bread/ for fruit
Panier / Porte agrumes
Brot-/Früchtekorb
Cesto por pan/ por cítricos
mm. 1,2

cm. 33 x 26
H cm. 20
13" x 10 1/5"
H 7 7/8"

704



Portatovaglioli
Napkin holder
Distributeur de serviettes
Serviettenhalter
Portaservilletas
mm. 1,2

cm. 13 x 13
5 1/9" x 5 1/9"

270



Portatovaglioli
Napkin holder
Distributeur de serviettes
Serviettenhalter
Portaservilletas
mm. 1,2

cm. 12,5 x 4,5
H cm. 7
5" x 1 7/8"
H 2 3/4"

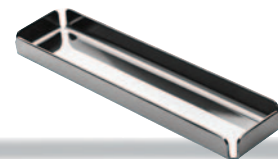

Portastuzzicadenti
Toothpick container
Porte-cure-dents
Zahnstocherbehälter
Porta-palillos
mm. 1,2

cm. 11 x 3
4 1/3" x 1 1/5"

424

206



mm. 1,2 Vassoio per pasticceria cm. 26 x 12 10¹/₄" x 4³/₄"
 Patisserie tray cm. 60 x 12 23³/₅" x 10¹/₅"
 Plateau pour patisserie
 Patisserie Tablett
 Bandeja para pasteleria

205



con piedistallo cm. 26 x 12
 with foot cm. 60 x 12
 avec socle H cm. 13
 mit Fuss
 con pies 10¹/₄" x 4³/₄"
 23³/₅" x 10¹/₅"
 H 5¹/₉"

153

NEW



mm. 1,2 Vassoio portabicchieri impilabile cm. 38 x 27
 Stackable tray for glasses
 Plateau porte verres empilable
 Stapelbare Gläserträger Tablett 15" x 10⁵/₈"
 Bandeja porta vasos impilable

505

NEW



mm. 1,2 Vassoio per carrelli cm. 56 x 40 16" x 22"
 Tray for rack trolley
 Plateau pour chariot porte-plateau
 Tablett für Rack
 Bandeja para estante

150



mm. 1,2 Platto concavo Ø cm. 14 Ø 5¹/₂"
 Crescent plate Ø cm. 18 Ø 7"
 Plateau concave Ø cm. 20 Ø 7⁷/₈"
 Konkave Platte Ø cm. 22 Ø 8⁵/₈"
 Plato concavo Ø cm. 24 Ø 9¹/₂"
 Ø cm. 26 Ø 10¹/₄"
 Ø cm. 28 Ø 11"

NEW



mm. 1,2 Cestino per pane Ø cm. 20 Ø 7⁷/₈"
 Bread basket Lt. 2 oz. 67³/₅"
 Corbeille pour pan
 Brotschale
 Cuenco para pan

154

284



mm. 1,2 Vassoio rettangolare da servizio cm. 30x21 11³/₄" x 8¹/₄"
 Rectangular service tray cm. 35x24 13³/₄" x 9¹/₂"
 Plateau rectangulaire pour service cm. 40x27 15³/₄" x 10⁵/₈"
 Tablett rechteckig für Service cm. 45x31 17³/₄" x 12¹/₄"
 Bandeja rectangular da servicio cm. 50x34 19⁵/₈" x 13³/₈"
 cm. 60x42 23⁵/₈" x 16¹/₈"

283



mm. 1,2 Vassoio tondo da servizio Ø cm. 27 Ø 10⁵/₈"
 Round service tray Ø cm. 35 Ø 13³/₄"
 Plateau rond pour service Ø cm. 40 Ø 15³/₄"
 Tablett rund für Service
 Bandeja redonda por servicio

415



mm. 1,2 Cloche per servizio, mantieni calore Ø cm. 20
 Cloche for service, heat keeper
 Cloche pour service, mainteneur de chaleur
 Service-Cloche, Wärmepflege Ø 7⁷/₈"
 Cloche de servicio, mantenedor de calor.



225



Cloche trasparente con pomolo Ø cm. 12 Ø 4³/₄"
 Transparent cloche with knob Ø cm. 22 Ø 8⁵/₈"
 Cloche transparente Ø cm. 28 Ø 11"
 Transparente Teller cloche
 Tapa transparente

155

NEW



mm. 1,2 Porta noccioli Ø cm. 6 Ø 2²/₅"
 Olive seeds jar H cm. 5 H 2"
 Porte noyaux cl. 5 oz. 1³/₄"
 Aderhalter
 Porta granos

721



mm. 1,2
Coppa termica con cloche
Insulated cup with cloche
Coupe thermique avec cloche
Isolier-Eisfruchtbecher mit Deckel
Copa térmica con tapa

Ø cm. 8,5 Ø 3 1/3"
cl. 15 oz. 6

259



mm. 1,2
Ciotola con base
Bowl with base
Bol avec socle
Obstschale auf Fuss
Cuenco con pedestal

Ø cm. 20
H cm. 14,3
lt. 2,1

Ø cm. 28
H cm. 18,3
lt. 5,7

Ø 5 2/3"
H 7 7/8"
gal. 1/2

Ø 11"
H 7 1/5"
gal. 1 1/2

864



GALA
Cestino semitraforato
Half fretworked basket
Corbeille demi-ajouré
Schale, halbgelocht
Frutero semiperforado

mm. 0,8

Ø cm. 22 Ø 8 5/8"
H cm. 5,7 H 2 1/4"
cl. 150 oz. 50 3/4

834



GALA
Cestino portafrutta
Round basket
Corbeille ronde
Schale, rund
Frutero redondo

mm. 0,8

Ø cm. 22 Ø 8 5/8"
H cm. 5,7 H 2 1/4"
cl. 150 oz. 50 3/4

Ø cm. 34 Ø 13 3/8"
H cm. 5,7 H 2 1/4"
cl. 500 gal. 1 1/3



GALA
Cestino traforato
Fretworked basket
Corbeille ajouré
Schale, gelocht
Frutero perforado

mm. 0,8

Ø cm. 22 Ø 8 5/8"
H cm. 5,7 H 2 1/4"
cl. 150 oz. 50 3/4

863

254



Supporto per informazioni o menu
Menu / Card holder
Porte nom numéro de table
Karten / Speisekartenhalter
Porta informaciones o menu

Ø cm. 6 Ø 2 1/2"
H cm. 9 H 3 1/2"



Portamenù
Menù holder
Porte-menu
Menükartenhalter
Portamenù

cm. 21 x 13,5 8 5/8" x 5 3/8"
H cm 29,7 H 11 3/4"



Portanumero
Table number stand
Numbers etched to order
Porte numéro de table
Tischnummernständer
Porta numero de mesa

A
Ø cm 8,3
H cm 47,3

B
Ø cm 8,3
H cm 24

A
Ø 3 1/4"
H 18 5/8"

B
Ø 3 1/4"
H 9 1/2"

994

712



mm. 1,2 Chillcup per burro e caviale con base
Chillcup for butter and caviar with base
Chillcup pour beurre et caviar avec socle
Chillcup für Butter und Kaviar mit Fuß
Chillcup para mantequilla y caviar
con pedestal

713



Chillcup per burro
Chillcup for butter
Chillcup pour beurre
Chillcup für Butter
Chillcup para mantequilla

Ø cm. 12
cl. 15
Ø 4 3/4"
oz. 5 1/8



Servizio per caviale
Caviar set
Service à caviar complet
Kaviarschale
Servicio para caviar

Ø cm. 18
cl. 15
Ø 7 1/8"
oz. 5 1/8

301



301A

301C

301B

mm. 0,8 Chillcup per cocktail di gamberetti Supreme bowl, complete Coupe à crevettes Chillcup für Hummercocktail Chillcup para coctél mariscos	301 Ø cm. 15	Ø 5 7/8"
	cl. 17,5	oz. 6
	301A Ø cm. 15	301A Ø 5 7/8"
	301B Ø cm. 13,5	301B Ø 5 3/8"
	301C Ø cm. 9,5	301C Ø 3 3/4"
	cl. 17,5	oz. 6

725

722



mm. 0,6 Piatino per coppa gelato Under liner for ice-cream bowl Petit plat soucoupe glace Unterteller für Eisschale Platillo melado	Ø cm. 12	Coppa per gelato e macedonia Ice-cream and salad fruit bowl with stand Coupe à glace et macédoine Eisfrüchteschale Copa helado y macedonia	Ø cm. 8,5 cl. 15
	Ø 4 3/4"		Ø 3 3/4" oz. 5 1/8

mm. 1,2 Coppa per gelato Ice-cream bowl Coupe à glace Eisschale Copa helado	Ø cm. 9,5 cl. 17	Ø 3 3/4" oz. 6
--	---------------------	-------------------



723

498



mm. 1,2 Completo oliera con spargisale a 5 H cm. 22 H 8 5/8"
 Cruet and salt cellar set 5 pcs. cl. 22,5 (x 2) oz. 7 1/2 (x 2)
 Service huile-vinaigre 5 pcs. cl. 7,5 (x 3) oz. 2 1/2 (x 3)
 Essig-/Ölgestell 5-Tlg.
 Convoy vinagreras con saleros 5 pzs

507



mm. 1,2 Completo oliera con spargisale a 4 H cm. 22 H 8 5/8"
 Cruet and salt cellar set 4 pcs. cl. 22,5 (x 2) oz. 7 1/2 (x 2)
 Service huile-vinaigre 4 pcs. cl. 7,5 (x 2) oz. 2 1/2 (x 2)
 Essig-/Ölgestell 4-Tlg.
 Convoy vinagreras con saleros 4 pzs

506



430350

mm. 1,2 Oliera GALA H cm. 22 H 8 5/8"
 Cruet » cl. 22,5 (x 2) oz. 7 1/2 (x 2)
 2 pièces huile-vinaigre »
 Essig-/Ölgestell »
 Vinagreras »

525



mm. 1,2 Formaggera GALA cl. 20 oz. 6 3/4
 Parmesan cheese basin »
 Fromagère »
 Käsedose »
 Quesera-Azucarero »

513



430510SS 430510ST

mm. 1,2 Spargisale, portastecchi GALA H cm. 15
 Salt-cellar with toothpick container » cl. 7,5 (x 3)
 Sel-poivre/porte cure-dents »
 Salz-Pfeffer-Zahnstocherbehälter » H 5 7/8"
 Saleros y pimentero y palillero » oz. 2 1/2 (x 3)

702



mm. 1,2 Mini burriera con coperchio cm. 12 x 6 4 3/4" x 2 1/3"
 Small butter dish w/lid cl. 15 oz. 5 1/8
 Petit beurrier a/couvercle
 Mini Butterdose m/Deckel
 Pláttillo para mantequilla con tapa



Dry Aged

DRY A G E D

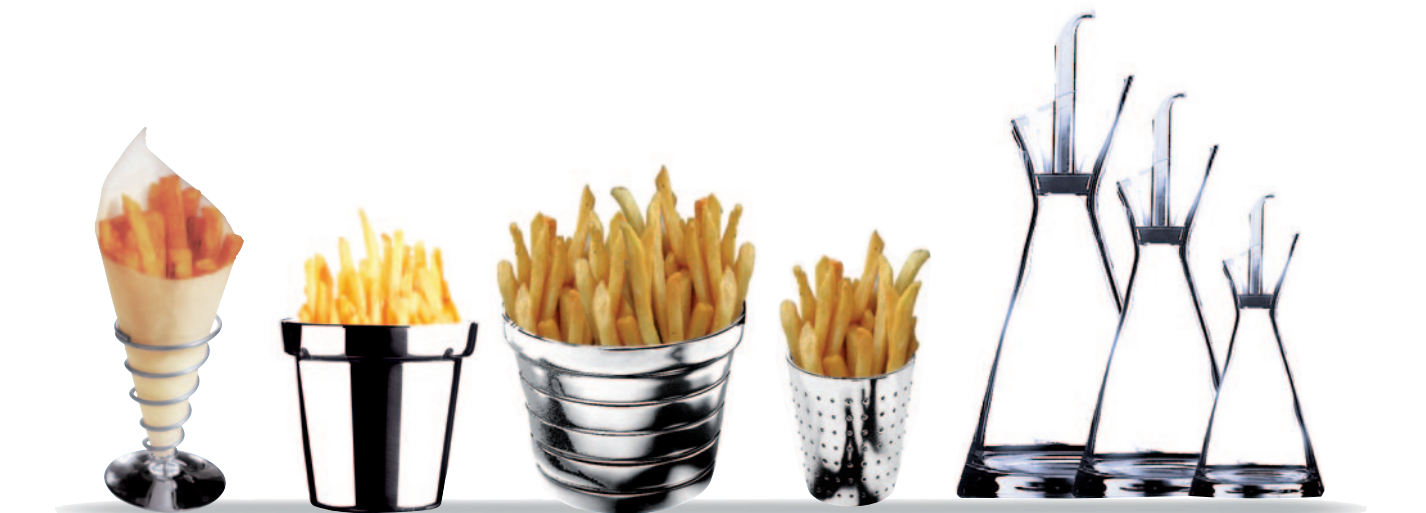

620

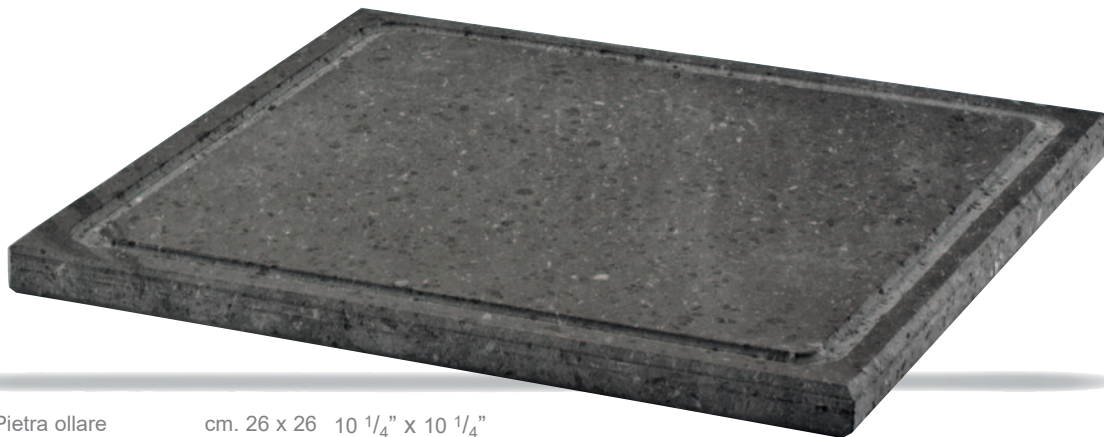

Pietra ollare cm. 26 x 26 10 1/4" x 10 1/4"
 Soapstone
 Ardoise
 Speckstein
 Pizarra

700



H cm 10 H 4"
 cl. 35 oz. 11 7/8

mm. 1,2 Portapatatine fritte
 French fry holder for table
 Porte pommes frites pour table
 Kartoffelbehälter für Tisch
 Porta patatas fritas por mesa

260



Ø cm 10 H 3 3/4"
 H cm 9,5 Ø 3 7/8"

289



H cm. 10 H 3 7/8"
 Ø cm. 6 Ø 2"

902



H cm 8 H 3 1/4"
 Ø cm 7 Ø 2 3/4"

282



mm. 1,2 Braciere con pietre naturali Ø cm. 15 Ø 5 7/8"
 Table grill with natural stones Ø cm. 22 Ø 8 5/8"
 Brasero avec pierres naturelles Ø cm. 32 Ø 12 5/8"
 Feuerschale mit Natursteine
 Hoguera c/piedras naturales

572



Ampolla cl. 20 oz. 6 3/4
 Cruet cl. 34 oz. 11 1/2
 Huilliere cl. 62 oz. 21
 Öl-/Essigflaschen
 mit Spender
 Vinagrera

1136

1136

10001136



10001136

UNI

Coltello bistecca cm. 21,3 8 1/4"

Steak knife

Couteau entrecôte

Steakmesser

Cuchillo bistek

10101136

10231136



10101136

NORMA

10231136

BOHEME

Coltello bistecca cm. 23 9 1/8"

Steak knife

Couteau entrecôte

Steakmesser

Cuchillo bistek

10141136

1020B1136

10341136



10141136

ROMA

1020B1136

10341136

NATURA

Coltello bistecca cm. 22,7 8 7/8"

Steak knife

Couteau entrecôte

Steakmesser

Cuchillo bistek

1144

1144

10001144



Coltello bistecca americano

cm. 25 9 5/8"

American steak knife

Couteau entrecôte américain

Amerikanisches Steakmesser

Cuchillo bistek americano

28215



mm. 1,2 Braciere con pietre naturali
Table grill with natural stones
Brasero avec pierres naturelles
Feuerschale mit Natursteine
Hoguera c/piedras naturales

Ø cm. 15 Ø 5 7/8"

28222



mm. 1,2 Braciere con pietre naturali
Table grill with natural stones
Brasero avec pierres naturelles
Feuerschale mit Natursteine
Hoguera c/piedras naturales

Ø cm. 22 Ø 8 5/8"

28232



mm. 1,2 Braciere con pietre naturali
Table grill with natural stones
Brasero avec pierres naturelles
Feuerschale mit Natursteine
Hoguera c/piedras naturales

Ø cm. 32 Ø 12 5/8"



A differenza del carbone, le pietre laviche rilasciano il calore molto lentamente e possono mantenere il cibo in cottura, senza cuocerlo eccessivamente

Unlike charcoal, lava stones release the heat very slowly and can cook food without over-cooking.

NEW

DRY AGED

NEW

78125



mm. 1,2 Sauteuse

cm. 25 9 5/8"

78130



mm. 1,2 Sauteuse

cm. 30 11 3/4"

78135



mm. 1,2 Sauteuse

cm. 35 13 3/4"

78140



mm. 1,2 Sauteuse

cm. 40 15 3/4"



574



Antipastiera quadra in vetro cm. 24,5 x 24,5 9⁵/₈" x 9⁵/₈"
 Hors d'oeuvre tray in glass
 Plat à hors d'oeuvre en verre
 Vorspeisenplatte aus Glas
 Entremesera en vidrio

575



Piatto quadro in vetro cm. 24,5 x 24,5 9⁵/₈" x 9⁵/₈"
 Square plate in glass
 Plateau carré en verre
 Platte, viereckig, aus Glas
 Plato cuadrado en vidrio

582



Supporto per cm. 43 x 14 16⁷/₈" x 5¹/₂"
 Multifunction stand for
 Support multi-usages pour
 Schalenhalter
 Soporte multiuso para

581



Supporto per cm. 36 x 14 14¹/₈" x 5¹/₂"
 Multifunction stand for
 Support multi-usages pour
 Schalenhalter
 Soporte multiuso para

570



mm. 1,2 UNO
 Cremiera
 Cream jug
 Crémier
 Sahnegießer
 Jarrita lechera
 Ø cm. 6 Ø 2³/₈"
 H cm. 8,8 H 3¹/₂"
 cl. 16 oz 5³/₈

594



mm. 1,2 UNO
 Cremiera con piedistallo
 Cream jug with base
 Crémier avec socle
 Sahnegießer auf Fuss
 Jarrita lechera con pedestal
 Ø cm. 6 Ø 2³/₈"
 H cm. 9 H 3¹/₂"
 cl. 16 oz 5³/₈

576



Servizio per pinzimonio in vetro Ø cm. 28 Ø 11"
 Salad set in glas H cm. 8 H 3 1/8"
 Service pour salade en verre cl. 300 oz. 101 1/2
 Service für Salat aus Glas
 Servicio para ensalada en vidrio

290576



Servizio per pinzimonio Ø cm. 28 Ø 11"
 Set for salad serving cl. 300 oz. 101 1/2
 Service à crudités
 Set "Salatdressing"
 Servicio para ensaladas

Ciambella termica per supporto Milleusi. La ciambella termica è usata per mantenere a lungo le temperature calde o fredde. Nel primo caso va riscaldata in forno ad una temperatura variabile tra i 160° C ed i 250° C, nel secondo caso va conservata in freezer a -14° C. In queste condizioni e in grado di mantenere la temperatura desiderata (da -5° C a +50° C) per un periodo che varia dai 20 ai 30 minuti

Thermal serving unit for multifunction stand.

The thermal serving unit is used to maintain heat or cold. In the first case, it must be heated in an oven at 160° C (+320° F) -250° C (+482° F). In the second case in a Freezer at -14° C (-57° F). In these conditions it is able to maintain the food either hot or cold for a period between 20 and 30 minutes at the desired temperature (from -5° C (-41° F) to +50° C (+122° F)).

Disque thermique pour support multi-usages. Le disque thermique est utilisé pour maintenir la chaleur ou le froid. Dans un cas, le disque est préchauffé dans le four à une température variant de 160° C a 250° C. Dans un second cas, le disque peut être refroidi jusqu'à -14° C. Dans ces conditions, le disque est en mesure de maintenir la chaleur ou la fraîcheur pendant un temp variable de 20 a 30 minutes, a la température voulue (de -5° C a +50° C).



583
 Ciambella termica per supporti
 Thermal serving unit for stands
 Disque thermique pour support
 Thermische Ringröhre für Hälter
 Bobina térmica para soportes
 Ø cm. 12 - Ø 4 3/4"

Der Warmhalteteller mit Thermikelement dient zum Servieren von warm- oder kalzuhaltenden Speisen, also sowohl zur Speicherung von Wärme als auch von Kälte. Zum Warmhalten erhitzt man das runde Thermikelement im Ofen auf 160 bis 250° C. Zum Kalthalten kühlt man im Gefrierfach das runde Thermikelement auf -14° C ab. Derart eingefügt in die Vertiefung des Warmhaltetellers kann man Speisen bis zu 30 min bei einer gewünschten Temperatur zwischen -5° C und +50° C kalt bzw. warm halten.

Bobina térmica para soporte multiuso. La bobina térmica puede ser utilizada para mantener el calor o el frío. En el primer caso, se calienta en el horno a una temperatura variable entre 160° C y 250° C; en el segundo, se mete en un congelador a -14° C. En estas condiciones, es capaz de mantener los alimentos calientes o fríos durante un periodo que oscila entre 20 y 30 minutos a la temperatura deseada (de -5° C a +50° C).



582

580



Pirofila ovale in fine china cm. 37 x 24 14 5/8" x 9 3/8"
 Fine china oval bowl cl. 300 oz. 101 1/2
 Plat oval en porcelaine à feu
 Auflaufform, oval aus Porzellan
 Pirophila oval en porcelana

579



Lasagnera in fine china cm. 34,5 x 24,5 13 5/8" x 9 5/8"
 Fine china Lasagne's bowl cl. 300 oz. 101 1/2
 Plat rectangulaire en porcelaine à feu
 Auflaufform, quadr. aus Porzellan
 Fuente para Lasagne en porcelana



Room Service

272



mm. 0,8
 Piatto termico con copripiatto e ciambella termica
 Insulated plate with cover and thermal serving unit
 Plat thermique avec couvre-plat et disque thermique
 Warmhalteteller mit Tellerglocke und Thermikelement
 Plato térmico con cubre platos y bobina térmica

Ø cm. 28,5
 Ø cm. 30,5
 Ø cm. 33,7

Ø 11 1/4"
 Ø 12"
 Ø 13 1/4"

273



mm. 0,8
 Piatto termico con cloche e ciambella termica
 Insulated plate with cloche and thermal serving unit
 Plat thermique avec cloche et disque thermique
 Warmhalteteller mit Tellerglocke und Thermikelement
 Plato térmico con tapadera y bobina térmica

Ø cm. 28,5
 Ø cm. 30,5
 Ø cm. 33,7

Ø 11 1/4"
 Ø 12"
 Ø 13 1/4"

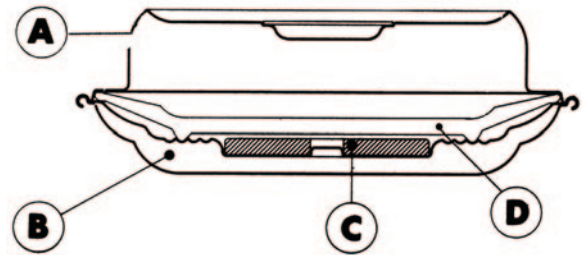

La ciambella termica © è usata per mantenere a lungo le temperature calde o fredde.

Nel primo caso va riscaldata in forno ad una temperatura variabile tra i 60°C ed i 150°C; nel secondo caso in Freezer a -14°C. In queste condizioni è in grado di mantenere la temperatura desiderata (da -5°C a +50°C) per un periodo che varia dai 20 ai 30 minuti.

The Thermal serving unit © maintains food at hot or cold temperatures for about 30 minutes.

The disk can be placed in an oven at 140°C (302°F) or in a freezer at -14°C (-57°F).

Le disque thermique © est utilisé pour maintenir la chaleur ou le froid. Dans un cas, le disque est préchauffé dans le four à une température variant de 60°C à 150°C. Dans un second cas, le disque peut être refroidi jusqu'à -14°C. Dans ces conditions, le disque est en mesure de maintenir la chaleur ou la fraîcheur pendant un temps variable de 20 à 30 minutes, à la température voulue (de -5°C à -50°C).

Der Warmhalteteller mit Thermikelement dient zum Servieren von warm- oder kalzuhaltenden Speisen, also sowohl zur Speicherung von Wärme als auch von Kälte. Zum Warmhalten erhitzt man das runde Thermikelement im Ofen auf 60° bis 150° C. Zum Kalthalten kühlt man im Gefrierfach das runde Thermikelement auf -14° C ab. Derart eingefügt in die die Vertiefung des Warmhaltetellers kann man Speisen bis zu 30 min bei einer gewünschten Temperatur zwischen -5° C und +50° C kalt bzw. warm halten.

La bobina térmica © puede ser utilizada para mantener el calor o el frío. En el primer caso se calienta en el horno a una temperatura variable entre 60°C y 150°C; en el segundo, se mete en un congelador a -14°C. En estas condiciones es capaz de mantener los alimentos calientes o fríos durante un periodo que oscila entre 20 y 30 minutos a la temperatura deseada (de -5° C a +50° C).

Una rivoluzionaria soluzione per un servizio ai piani di alta classe, nella massima sicurezza anti-incendio, evitando l'uso di fiamme o fornelli.

A revolutionary solution for room service, eliminating the need of fuel or electric wires.

C'est une solution révolutionnaire pour un Service à l'Étage de qualité en conformité avec les règles de sûreté anti-incendie et en évitant l'usage de flammes ou feux ouverts.

Dies ist eine revolutionäre Lösung für den hohen Anspruch an excellenten Zimmerservice. Man vermeidet dabei den Gebrauch von offenem Feuer oder elektrischen Platten und vermeidet Konflikte mit den Brandschutzrichtlinien der jeweiligen Länder

Es una solución revolucionaria para un servicio de habitación de alta calidad que respeta las normas de seguridad contra incendios, pues evita el peligro de l'uso de llamas y hornillos encendidos.

425
Tiffin' box

H cm. 21,3
cm. 24,5 x 25,3

H 8 2/5"
9 5/8" x 10"

Colori personalizzati a disposizione
Custom colors available
Couleurs personnalisées
Benutzerdefinierte Farben verfügbar
Colores personalizados disponible



NEW

ROOM SERVICE

NEW

425



153



153

mm. 1,2 Vassoio per carrelli cm. 56 x 40 22" x 16"
 Tray for rack trolley
 Plateau pour chariot porte-plateau
 Tablett für Rack
 Bandeja para estante

429

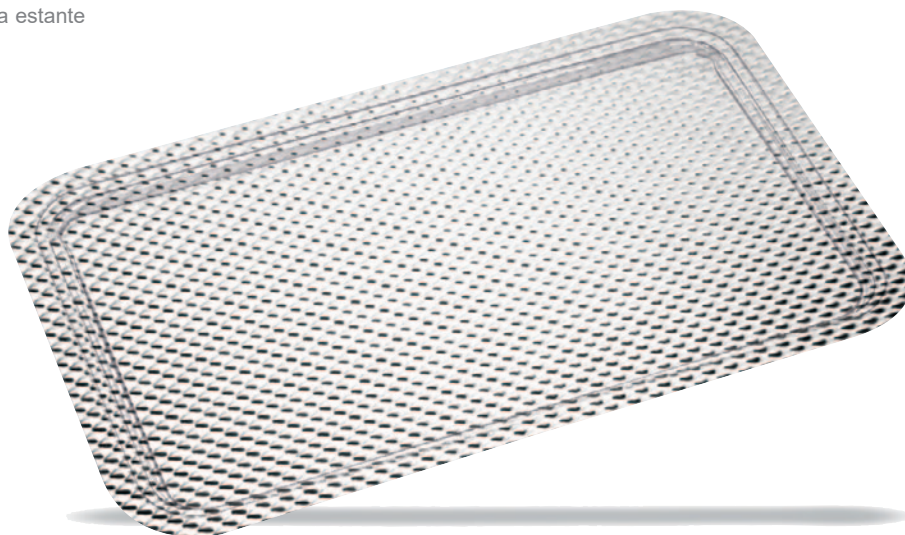

429

mm. 1,0 Vassoio per carrelli cm. 63 x 45 24 11/16" x 17 3/4"
 Tray for rack trolley
 Plateau pour chariot porte-plateau
 Tablett für Rack
 Bandeja para estante

429

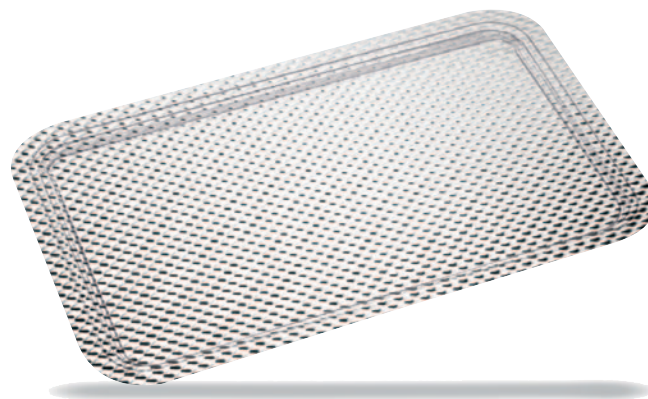

429

mm. 1,0 Vassoio per carrelli cm. 45 x 31 17 3/4" x 12 1/4"
 Tray for rack trolley
 Plateau pour chariot porte-plateau
 Tablett für Rack
 Bandeja para estante





Menu & Banquet

305

316



mm. 1,2 Vassoio rettangolare
Rectangular tray
Plateau rectangulaire
Tablett, rechteckig
Bandeja rectangular

cm. 40,5 x 27,5 15⁷/₈" x 10³/₄"
cm. 45 x 31 17³/₄" x 12¹/₄"

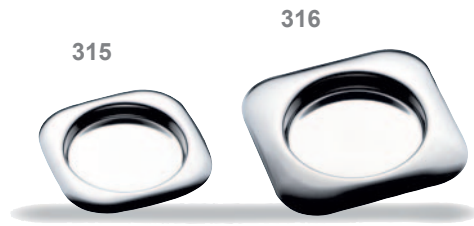

315 316

mm. 1,2 Sottobicchiere e sottobottiglia
Glass and bottle coaster
Dessous de verre et de bouteille
Glasuntersatz - Flaschenteller
Posavaso y Posabotella

cm. 10 x 10 4" x 4"
cm. 12,5 x 12,5 5" x 5"

323

313



mm. 1,2 Sottopiatto quadrato
Square charger
Assiette de bienvenue carré
Platzteller, viereckig
Bajo plato cuadrado

cm. 32 x 32 12¹/₂" x 12¹/₂"



mm. 0,8 Sottopiatto
Charger
Assiette de bienvenue
Platzteller
Bajo plato

Ø cm. 31 Ø 12 1/4"

319

320



mm. 1,2 Vassoio quadrato
Square plate
Plateau carré
Tablett, viereckig
Bandeja cuadrada

cm. 32 x 32 12¹/₂" x 12¹/₂"



mm. 1,2 Vassoio "Tête à tête"
"Tête à tête" tray
Plateau "Tête à tête"
Tablett "Tête à tête"
Bandeja "Tête à tête"

Ø cm. 22 Ø 8 5/8"

312



mm. 1,2 Antipastiera 4 scomparti in cristallo cm. 40,5 x 27,5 15⁷/₈" x 10³/₄"
 Hors-d'oeuvre tray 4 compt.
 Plat à hors-d'oeuvre 4 comp. cristal
 Vorspeisenplatte 4 Einsatze
 Entremesera

325

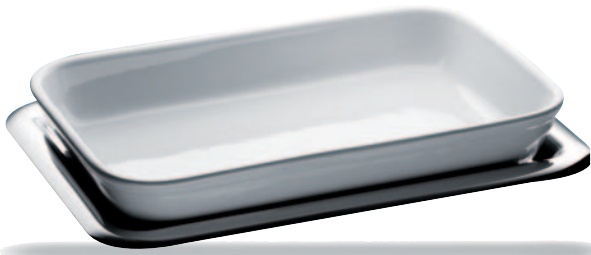

mm. 1,2 Lasagnera rettangolare cm. 40,5 x 27,5 15⁷/₈" x 10³/₄" mm. 1,2
 Set for Lasagne lt. 3 oz. 102 1/9
 Service pour Lasagne
 Set mit Porzellanschale, rech.
 Servicio para Lasagne

324



mm. 1,2 Risottiera tonda Ø cm. 31 Ø 12 1/4"
 Set for risotti lt. 2 oz. 67 3/5
 Service pour risotto
 Set mit Porzellanschale, rund
 Servicio para arroces

309



mm. 1,2 Portatovaglioli cm. 22 x 22 8⁵/₈" x 8⁵/₈" mm. 1,2
 Napkin holder
 Distributeur de serviettes
 Serviettenhalter
 Portaservilletas

31802



mm. 1,2 Portaspezie cm. 15 x 15 5 7/8" x 5 7/8"
 Aromatic condiments set H cm. 25,5 H 10"
 Service pour aromatiques cl. 11 (x 8) oz. 3 3/4 (x 8)
 condiments
 Gewürzständer
 Servicio para aromaticos y
 condimentos

308



mm. 1,2 Cestino per pane
Basket
Corbeille
Brotschale
Cuenco

cm. 22 x 22 8⁵/₈" x 8⁵/₈" mm. 1,2
cl. 80 oz. 27

317

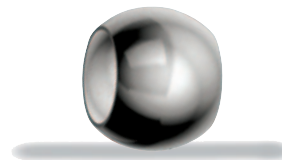

mm. 1,2 Allacciatovaglioli
Napkins ring
Rond de serviette
Serviettenring
Servilletero

Ø cm. 6 Ø 2 3/8"

306



mm. 1,2 Completo oliera con spargisale
Cruet and salt cellar set 4 pcs.
Service huile-vinaigre 4 pcs.
Essig-/Ölgestell 4-Tlg.
Convoy vinagreras con saleros

H cm. 19 H 7³/₈"
cl. 18 (x2) oz. 6 (x2)
cl. 11 (x2) oz. 3³/₄ (x2)

307



mm. 1,2 Formaggera
Parmesan cheese basin
Fromagère
Kasedose
Quesera-Azucarero

cl. 20 oz. 6 3/4

310



mm. 1,2 Portabicchieri di carta
Paper cup holder
Porte-gobelets de papier
Papierbecherständer
Portavasos de papel

cm. 21 x 11 8³/₁₆" x 4¹/₄"
H cm. 22,8 H 8 7/8"

321



mm. 1,2 Portapiatti di plastica
Plastic paper plate dispenser
Porte-plateau de plastique
Stand für Plastik Platten
Portaplatos de plastica

Ø cm. 22 Ø 8 5/8"

164



mm. 1,2 Vassoio rettangolare
Rectangular tray
Plateau rectangulaire
Tablett, rechteckig
Bandeja rectangular

cm. 40 x 29 15³/₄" x 11³/₈"
cm. 49 x 36 19¹/₄" x 14¹/₈"

165



mm. 1,2 Vassoio rotondo
Round tray
Plateau ronde
Tablett, rund
Bandeja redonda

Ø cm. 35 Ø 13 ³/₄"

168



mm. 1,2 Completo olera con spargisale
Cruet and salt cellar set 4 pcs
Service huile-vinaigre 4 pièces
Essig-/Ölgestell 4-Tlg.
Convoy vinagreras con saleros
4 piezas

H cm. 20 H 7⁷/₈"
cl. 18 (x 2) oz. 6 (x 2)
cl. 11 (x 2) oz. 3³/₄ (x 2)

169



mm. 1,2 Formaggera
Parmesan cheese basin
Fromagère
Kasedose
Quesera-Azucarero

cl. 20 oz. 6 ³/₄



408



mm. 1,2 TALAMO
Vassoio rettangolare
Rectangular tray
Plateau rectangulaire
Tablett, rechteckig
Bandeja rectangular

cm. 29 x 23 11³/₈" x 9"
cm. 47 x 37 18¹/₂" x 14¹/₂"

409



mm. 1,2 TALAMINO
Vassoio quadrato
Square tray
Plateau carré
Tablett, viereckig
Bandeja cuadrada

cm. 37 x 37 14¹/₂" x 14¹/₂"

406

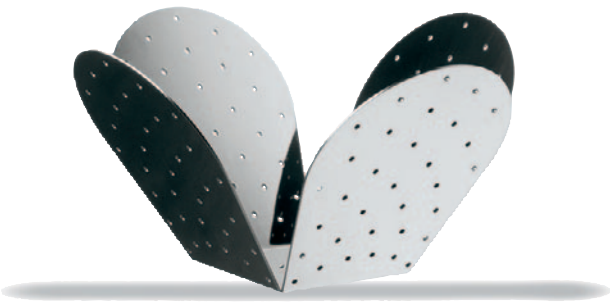

mm. 1,2 BOCCIOLIO
Cestino
Basket
Corbeille
Obstschale
Frutero
Ø cm. 24,5
H cm. 13,5
lt. 4
Ø 9 2²/₃"
H 5 1¹/₃"
gal. 1

407



mm. 1,2 BOCCIOLINO
Cestino
Basket
Corbeille
Obstschale
Frutero
Ø cm. 16,5
H cm. 15,5
lt. 2,64
Ø 6 1²/₂"
H 6 1¹/₉"
oz. 89 1¹/₄

410



mm. 1,2 COROLLA
Completo oliera con spargisale
Cruet and salt cellar set
Service huile-vinaigre
Essig-/Ölgestell 4-Tlg.
Convoy vinagreras con saleros
H cm. 20- cl.18(x2) cl.11(x2)
H 7⁷/₈" - oz.6(x2) oz.3³/₄ (x2)

411
PISTILLA
Formaggera
Parmesan cheese basin
Fromagère
Käsedose
Quesera-Azucarero
cl. 20
oz. 6³/₄

505



mm. 1,2 COROLLA
Cestello portacondimenti
Basket for aromatic condiments
Corbeille pour aromatiques condiments
Essig-und Öl Flaschenhalter
Cesto para aromaticos y condimentos
H cm. 20
cl.25(x2)
cl.11(x2)
H 7⁷/₈"
oz.8¹/₂(x2)
oz.3³/₄(x2)

331



mm. 1,2 Sottopiatto
Charger
Assiette de bienvenue
Platzteller
Bajo plato
Ø cm. 33 Ø 13"

333

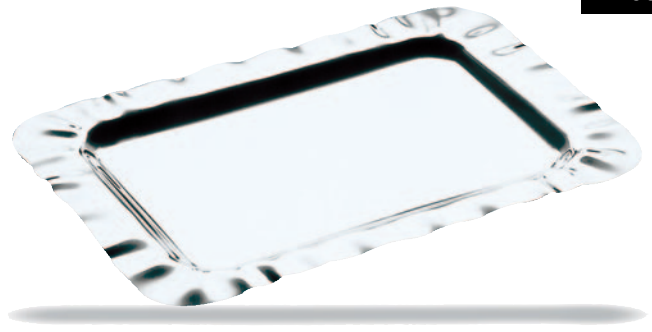

mm. 1,2 Vassoio rettangolare
Rectangular tray
Plateau rectangulaire
Tablett, rechteckig
Bandeja rectangular
cm. 50 x 34 19⁵/₈" x 13³/₈"

332



mm. 1,2 Vassoio ovale
Oval tray
Plateau oval
Tablett, oval
Bandeja oval
cm. 49 x 33 19¹/₄" x 13"

337



mm. 1,2 Cestino tondo
Round basket
Corbeille ronde
Obstschale, rund
Frutero redondo
Ø cm. 31 Ø 12¹/₄"
cl. 125 oz. 42 ¹/₄

335



mm. 1,2 Completo oliera con spargisale
Cruet and salt cellar set
Service huile-vinaigre
Essig-/Ölgestell 4-Tlg.
Convoy vinagreras con saleros
H cm. 21
cl. 22,5(x2)
cl. 7,5(x2)
H 8¹/₄"
oz. 7¹/₂(x2)
oz. 2¹/₂(x2)

336



mm. 1,2 Formaggera
Parmesan cheese basin
Fromagère
Käsedose
Quesera-Azucarero
cl. 20 oz. 6³/₄

201

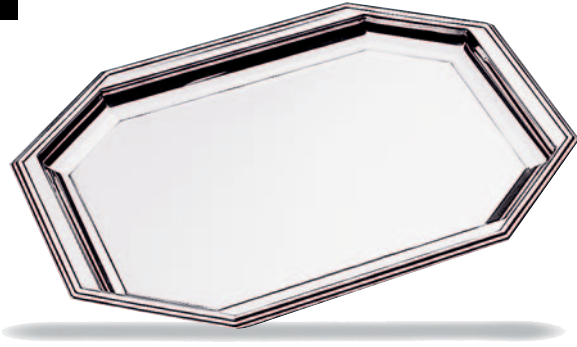

mm. 1,2 Vassoio
Tray
Plateau
Tablett
Bandeja
cm. 30 x 24 11³/₄" x 9¹/₂"
cm. 40 x 31 15³/₄" x 12¹/₄"
cm. 50 x 39 19⁵/₈" x 15³/₈"

202

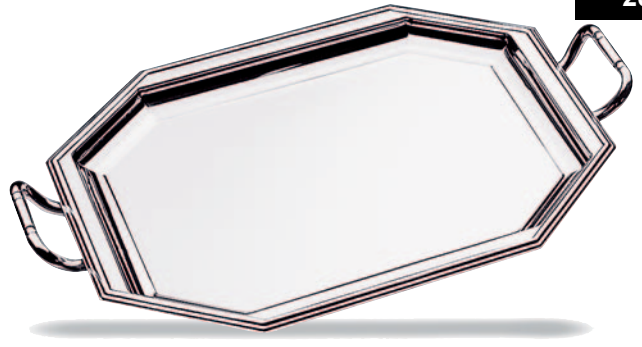

mm. 1,2 Vassoio con maniglie
Tray with handles
Plateau avec anses
Tablett mit Griffen
Bandeja con asas
cm. 40 x 31 15³/₄" x 12¹/₄"
cm. 50 x 39 19⁵/₈" x 15³/₈"

203



mm. 1,2 Vassoio
Tray
Plateau
Tablett
Bandeja
Ø cm. 25 Ø 9 ⁷/₈"
Ø cm. 31 Ø 12 ¹/₄"

199

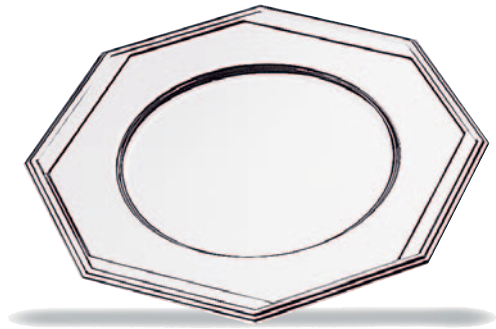

mm. 1,2 Sottopiatto
Charger
Assiette de bienvenue
Platzteller
Bajo plato
Ø cm. 31 Ø 12¹/₄"

716



mm. 0,8 Piattino per burro con coperchio e griglia
Butter dish with inserted grill and cover
Beurrer avec grill et couvercle
Butterkühler mit Einsatzsieb und Deckel
Plato para mantequilla con rejilla y tapa
Ø cm. 9 cl. 25 Ø 3¹/₂"
oz 8 ¹/₂

210

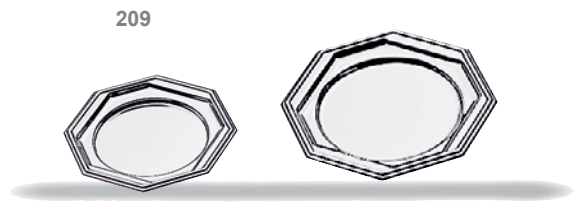

mm. 0,8 Sottobicchiere e sottobottiglia
Glass and bottle coaster
Dessous de verre et de bouteille
Glasuntersatz - Flaschenteller
Posavaso y Posabotella
209
Ø cm. 10,5 Ø 4¹/₈"
Ø cm. 12,5 Ø 4⁷/₈"

502



mm. 0,8 Completo oliera con spargisale
Cruet and salt cellar set
Service huile-vinaigre 4 pièces
Essig-/Ölgestell 4-Tlg.
Convoy vinagreras con saleros 4 pzs

H cm. 21 H 8 1/4"
cl. 22,5 (x 2) oz. 7 1/2 (x 2)
cl. 7,5 (x 2) oz. 2 1/2 (x 2)

522



mm. 0,8 Formaggera cl. 20 oz. 6 3/4
Parmesan cheese basin
Fromagère
Käsedose
Quesera-Azucarero

844



mm. 1,2 Cestino rettangolare
Rectangular basket
Corbeille rectangulaire
Obstschale rechteckig
Panera rectangular

cm. 30 x 24 11 3/4" x 9 1/2"
cl. 200 oz. 67 5/8

843



mm. 1,2 Cestino
Round Basket
Corbeille
Obstschale
Frutero

Ø cm. 25 Ø 9 7/8"
cl. 150 oz. 50 3/4

103



mm. 1,2 Sottopiatto Ø cm. 33 Ø 13"
 Charger Ø cm. 35 Ø 13 3/4"
 Assiette de bienvenue
 Platzteller
 Bajo plato

131



mm. 0,8 Sottopiatto RAFFAELLO Ø cm. 32,5 Ø 12 3/4"
 Charger »
 Assiette de bienvenue »
 Platzteller »
 Bajo plato »

294



mm. 1,2 Porta pasticcini con piedistallo Ø cm. 19 Ø 7 1/2"
 Petit-fours stand with base H cm. 14,5 H 5 3/4"
 Porte-petits-fours avec socle
 Petit Fours-Ständer Ø cm. 24 Ø 9 1/2"
 Porta dulces con pedestal H cm. 14,5 H 5 3/4"

7003A



mm. 1,2 Alzata portafrutta 2 piani Ø cm. 24 Ø 9 1/2"
 Fruit holder 2 layers Ø cm. 31 Ø 12 1/4"
 Serviteur 2 etages H cm. 24,5 H 9 5/8"
 Etagere 2 stufig
 Frutero 2 pisos

293



mm. 1,2 Porta pasticcini con piedistallo 2 Piani Ø cm. 12 Ø 4 3/4"
 Petit-fours stand with base 2 Layers Ø cm. 19 Ø 7 1/2"
 Porte-petits-fours avec socle 2 Etages H cm. 27 H 10 5/8"
 Mokkaetagere 2 Ebenen
 Porta dulces con pedestal 2 Pisos

7003B



mm. 1,2 Alzata portafrutta 3 piani Ø cm. 19 Ø 7 1/2"
 Fruit holder 3 layers Ø cm. 24 Ø 9 1/2"
 Serviteur 3 etages Ø cm. 31 Ø 12 1/4"
 Etagere 3 stufig H cm. 35,5 H 14"
 Frutero 3 pisos

204



mm. 1,2 Porta macaron
Macarons server
Porte macarons
Macaronsträger
Porta macaron
Ø cm. 15 Ø 5 7/8"
H cm. 11,5 H 4 1/2"
cl. 20 oz. 6 3/4

715



mm.0,8 Piattino per burro con coperchio e griglia Ø cm. 9 Ø 3 1/2"
Butter dish with inserted grill and cover cl. 20 oz. 6 3/4
Beurrer avec grille et couvercle
Butterdose mit Einsatzsieb und Deckel
Plato para mantequilla con rejilla y tapa

105



mm. 1,2 Sottobicchiere Ø cm. 10 Ø 4"
Glass coaster
Dessous de verre
Glasuntersatz
Posavasos

106



mm.1,2 Sottobottiglia Ø cm. 12 Ø 4 3/4"
Bottle coaster
Dessous de bouteille
Flaschenteller
Posabotella

208



mm. 1,2 Piattino per pane Ø cm. 14 Ø 5 1/2"
Bread tray
Plat pour pan
Brot Platte
Plato para pan

292



mm. 1,2 Servizio per zucchero con cristallo Ø cm. 33 Ø 13"
Sugar set with crystal cl. 15(x3) oz. 5(x3)
Service à sucre avec cristal
Zuckerständer mit Kristalleinsätzen
Servicio para azúcar con cristales

497



mm. 1,2 Completo oliera con spargisale 5 pz. H.cm.21 H. 8 1/4"
 Cruet and salt cellar set 5 pcs cl. 30 (x2) oz. 10 1/8 (x2)
 Service huile-vinaigre 5 pièces cl. 8 (x3) oz. 2 3/4 (x3)
 Essig-Ölgestell 5-Tlg.
 Vinagreras 5 pza

509



mm. 1,2 Completo oliera con spargisale 4 pz. H.cm.21 H. 8 1/4"
 Cruet and salt cellar set 4 pcs cl. 30 (x2) oz. 10 1/8 (x2)
 Service huile-vinaigre 4 pièces cl. 8 (x2) oz. 2 3/4 (x2)
 Essig-Ölgestell 4-Tlg.
 Vinagreras 4 pza

508



mm. 1,2 Oliera H.cm.21 H. 8 1/4"
 Cruet cl. 30 (x2) oz. 10 1/8 (x2)
 2 pièces huile-vinaigre
 Essig-Ölgestell 2 Tlg.
 Vinagreras 2 pza

510



mm. 1,2 Spargisale portastecchi con base H. cm.14 H. 5 1/2"
 Salt cellar w/toothpick container w/base cl. 8 (x3) oz. 2 3/4 (x3)
 Sel, poivre, porte cure-dents a/socle
 Salz-Pfeffer-Zahnstocherbehälter 3-tlg.
 Sal & Pimenta & palillero 3 pza

350



Cristallo per spargisale art. 510
 Salt and pepper container for art. 510
 Cristal pour art. 510
 Ersatzglass für Art. 510
 Cristal por saleros art. 510
 cl. 8
 oz. 2 3/4

Ampolla
 Cruet
 Huilliere
 Öl-/Essigflasche
 Vinagrera
 H cm. 18 - cl. 30
 H 7 1/8" - oz. 10 1/8

510ST



Portastecchi senza base cl. 8 oz. 2 3/4
 Toothpick container w/out base
 Porte cure-dents sans/socle
 Zahnstocherbehälter ohne Fuß
 Palillero sin pedestal

611



mm. 1,2 Formaggera
Parmesan cheese basin
Fromagère
Käsedose
Quesera - Azucarero
cl. 20 oz. 6 3/4

512

430491SS



Cristallo per spargisale art. 512-602
Crystal glass container for art. 512-602
Cristal avec capsule pour art. 512-602
Erzatzglass mit Kapsel für art. 512-602
Cristal por saleros art. 512-602
cl. 11 - oz. 3 3/4

mm. 1,2 Spargisale-portastecchi
Salt cellar with toothpick container
Sel + poivre + cure dents
Salz-Pfeffer-Zahnstocherbehälter
Saleros y pimenteros y pallillero
H. cm.14 - cl. 11(x2)
H. 5 1/2" - oz. 3 3/4 (x2)

602



mm. 1,2 Completo olera con spargisale
Cruet and salt cellar set
Service huile-vinaigre 4 pièces
Essig-Ölgestell 4-tlg.
Convoy vinagreras con saleros
H. cm 19 H. 7 1/2"
cl. 18(x2) oz. 6(x2)
cl. 11(x2) oz. 3 3/4(x2)

601

430602



mm. 1,2 Oliera
Cruet
2 pièces huile-vinaigre
Essig-Ölgestell
Vinagreras
H. cm 19 H. 7 1/2"
cl. 18(x2) oz. 6(x2)

603



mm. 1,2 Oliera portacondimenti
Cruet for aromatic condiments
Huilière pour aromatiques condiments
Gewürzmenage
Vinagreras para aromaticos
y condimentos
H. cm 14,5 H. 5 3/4"
cl. 11(x2) oz. 3 3/4(x2)

430491

304



304
mm 1,2 Portamarmellata a 3 scomparti
Jam pack holder 3 compt.
Porte-confiture 3 comp.
Marmeladegestell 3 Einsätze
Marmeladero 3 comp.
H. cm. 19 - H. 7 1/2"

604

mm. 1,2 Oliera a 3 pezzi
Cruet 3 pcs
Huilière 3 pcs
Menage 3-Tlg.
Vinagreras 3 pzas
H. cm. 19 -cl.18(x2)-cl. 11
H. 7 1/2" - oz.6(x2) oz.3 3/4

231



mm. 0,8	Piatto ovale da portata bordo rinforzato	cm. 25 x 17	9 7/8" x 6 3/4"
	Oval serving plate with reinforced edges	cm. 30 x 21	11 3/4" x 8 1/4"
	Plat oval de service bord renforcé	cm. 35 x 24	13 3/4" x 9 1/2"
	Bratenplatte oval	cm. 40 x 27	15 3/4" x 10 5/8"
	Fuente ovalada borde reforzado	cm. 45 x 32	17 3/4" x 12 5/8"
		cm. 50 x 35	19 5/8" x 13 3/4"
		cm. 60 x 41	23 5/8" x 16 1/8"

241



mm. 0,8	Piatto ovale da portata pesce bordo rinforzato	cm. 55 x 24
	Oval serving fish plate with reinforced edges	cm. 70 x 29
	Plat à poisson oval bord renforcé	
	Fischplatte, oval	21 5/8" x 9 1/2"
	Fuente pescado borde reforzado	27 1/2" x 11 3/8"

233



mm. 1,2	Piatto ovale da portata mod. pesante	cm. 30 x 22	11 3/4" x 8 5/8"
	Oval serving plate with reinforced edges heavy mod.	cm. 35 x 26	13 3/4" x 10 1/2"
	Plat oval de service bord renforcé Mod. pesant	cm. 40 x 28	15 3/4" x 11"
	Bratenplatte, oval, schweres Mod.	cm. 45 x 31	17 3/4" x 12 1/4"
	Fuente ovalada nuevo modelo	cm. 50 x 34	19 5/8" x 13 3/8"

243



mm. 1,2	Piatto ovale da portata pesce mod. pesante	cm. 55 x 25
	Oval serving fish plate heavy weight	cm. 70 x 27
	Plat à poisson modèle Pesant	
	Fischplatte, oval, schweres Mod.	21 5/8" x 9 7/8"
	Fuente ovalada pescado nuevo modelo	27 1/2" x 10 5/8"

251



mm. 0,8	Piatto rotondo da portata bordo rinforzato	Ø cm. 27	Ø 10 5/8"
	Round serving plate with reinforced edges	Ø cm. 30	Ø 11 3/4"
	Plat rond de service bord renforcé	Ø cm. 35	Ø 13 3/4"
	Bratenplatte, rund	Ø cm. 40	Ø 15 3/4"
	Bandeja redonda borde reforzado		

269



mm. 0,8	Copripiatto sovrapponibile	GALA	Ø cm.28	Ø 11"
	Stackable cover for round plate	»		
	Couvre-plat	»		
	Stapelbarer Teller cloche	»		
	Cubre platos	»		



190

NEW



mm. 1,2
STOCCOLMA
 Cestino ovale
 Oval basket
 Corbeille, ovale
 Brotschale, oval
 Cuenco ovalado

cm. 23,5 x 15,5 9¹/₄" x 6¹/₉"
 cl. 75 oz. 25²/₅

NEW

192



mm. 1,2
STOCCOLMA
 Cestino rotondo
 Round Basket
 Corbeille, ronde
 Brotschale, rund
 Cuenco redondo

H cm. 5,7 H 2¹/₄"
 Ø cm. 22 Ø 8⁵/₈"
 cl. 85 oz. 28³/₄

263



mm. 0,8 Piatto tondo per legumi a 3 sc. Ø cm. 27 Ø 10 5/8"
 3 sections vegetable dish
 Plat à légumes rond - 3 compt.
 Teller rund 3 Abteilungen
 Bandeja para legumbres 3 comp.

264



mm. 0,8 Coperchio per piatto tondo art. 263 Ø cm. 25 Ø 9 7/8"
 Lid for art. 263
 Couvercle pour plat rond art. 263
 Deckel für Teller 3 Abtlg.
 Tapa para bandeja redonda art. 263

266



mm. 0,8 Piatto ovale per legumi a 2 sc. cm. 30 x 21 11 3/4" x 8 1/4"
 2 section vegetable dish
 Plat à légumes oval - 2 comp.
 Teller oval, 2 Abteilungen
 Bandeja para legumbres 2 comp.

267



mm. 0,8 Coperchio per piatto ovale art. 266 cm. 27 x 18 10 5/8" x 7 1/8"
 Lid for art. 266
 Couvercle pour plat oval art. 266
 Deckel für Teller, 2 Abtlg.
 Tapa para bandeja ovalada art. 266

235



mm. 1,2 Vassoio per gratin cm. 35 x 20 13 3/4" x 7 1/8"
 Tray for "gratin" cm. 40 x 24 15 3/4" x 9 1/2"
 Plat à "gratin"
 Gratinplatte
 Bandeja gratinar
 15 3/4" x 9 1/2"

236



mm. 0,8 Coperchio per Art. 235 cm. 35 x 20 13 3/4" x 7 1/8"
 Lid for Art. 235 cm. 40 x 24 15 3/4" x 9 1/2"
 Couvercle pour Art. 235
 Deckel für Art. 235
 Tapa para Art. 235

253



mm. 0,8 Cloche per piatto rotondo
Cloche for round plate
Cloche pour plat rond
Tellercloche für Bratenplatte rund
Tapa para fuente redonda

Ø cm. 27	Ø 10 5/8"
Ø cm. 35	Ø 13 3/4"
Ø cm. 40	Ø 15 3/4"

245



mm. 0,8 Cloche per piatto ovale
Cloche for oval plate
Cloche pour plat oval de service
Tellercloche für Bratenplatte oval
Tapa para fuente ovalada

cm. 30	11 3/4"
cm. 35	13 3/4"
cm. 40	15 3/4"
cm. 45	17 3/4"
cm. 50	19 5/8"

211



mm. 0,6 Vassoio rettangolare per pasticceria
Rectangular tray for cakes
Plat à tarte rectangulaire
Gebäckplatte, rechteckig
Bandeja

cm. 26 x 19	10 1/4" x 7 1/2"
cm. 31 x 21	12 1/4" x 8 1/4"

238



mm. 1,2 Vassoio per gratin e gastronomia
Tray for "Gratin-gastronomy"
Plat à "Gratin et gastronomie"
Gratinplatte für Gastronomie
Bandeja para gratinar y gastronomia

cm. 25 x 18	9 7/8" x 7 1/8"
cm. 30 x 22	11 3/4" x 8 5/8"
cm. 35 x 25	13 3/4" x 9 7/8"
cm. 40 x 29	15 3/4" x 11 3/8"
cm. 45 x 31	17 3/4" x 12 1/4"

247



mm. 0,8 Cloche con pomolo per sottopiatto
Cloche with knob for under plate
Cloche pour sous-assiette
Tellercloche
Tapa para fuente redonda

Ø cm. 7,5	Ø 3"
Ø cm. 10	Ø 4"
Ø cm. 10,5	Ø 4 1/16"
Ø cm. 13	Ø 5 1/16"
Ø cm. 14	Ø 5 1/2"
Ø cm. 14,5	Ø 5 5/7"
Ø cm. 20	Ø 7 7/8"
Ø cm. 22	Ø 8 5/8"
Ø cm. 24	Ø 9 1/2"
Ø cm. 26	Ø 10 1/4"
Ø cm. 28	Ø 11"
Ø cm. 30	Ø 12 1/8"
Ø cm. 31	Ø 12 1/8"
Ø cm. 32	Ø 12 5/8"
Ø cm. 33	Ø 13"

268



mm. 0,8 Copripiatto sovrapponibile
Stackable cover for round plate
Couvre-plat
Stapelbarer Tellercloche
Cubre platos

Ø cm. 20	Ø 7 7/8"
Ø cm. 24	Ø 9 1/2"
Ø cm. 26	Ø 10 1/4"
Ø cm. 27	Ø 10 5/8"
Ø cm. 28	Ø 11"
Ø cm. 30	Ø 11 3/4"
Ø cm. 31	Ø 12 3/8"
Ø cm. 33	Ø 13"

732



mm. 1,2 Zuppiera nuovo modello Ø cm. 14 - lt. 0,6 Ø 5 1/2" - oz. 20 1/4
 Soup tureen new mod. Ø cm. 18 - lt. 1,2 Ø 7" - oz. 40 5/8
 Soupière nouveau modele Ø cm. 20 - lt. 1,8 Ø 7 7/8" - oz. 60 7/8
 Suppenterrine neues Mod. Ø cm. 22 - lt. 2,5 Ø 8 5/8" - oz. 84 1/2
 Sopera nuevo Modelo Ø cm. 24 - lt. 3,1 Ø 9 1/2" - oz. 104 7/8
 Ø cm. 26 - lt. 3,9 Ø 10 1/4" - oz. 131 7/8
 Ø cm. 28 - lt. 5,1 Ø 11" - gal. 1 1/4

782



mm. 1,2 Legumiera nuovo modello Ø cm. 14 - lt. 0,6 Ø 5 1/2" - oz. 20 1/4
 Vegetable dish new model Ø cm. 18 - lt. 1,2 Ø 7" - oz. 40 5/8
 Légumiere nouveau modele Ø cm. 20 - lt. 1,8 Ø 7 7/8" - oz. 60 7/8
 Lègumier neues Modell Ø cm. 22 - lt. 2,5 Ø 8 5/8" - oz. 84 1/2
 Legumbrera nuevo Modelo Ø cm. 24 - lt. 3,1 Ø 9 1/2" - oz. 104 7/8
 Ø cm. 26 - lt. 3,9 Ø 10 1/4" - oz. 131 7/8
 Ø cm. 28 - lt. 5,1 Ø 11" - gal. 1 1/4

736



mm. 1,2 Coperchio per art. 732 - 782 Ø cm. 14 Ø 5 1/2"
 Lid for art. 732 - 782 Ø cm. 18 Ø 7"
 Couvercle pour art. 732 - 782 Ø cm. 20 Ø 7 7/8"
 Deckel für art. 732 - 782 Ø cm. 22 Ø 8 5/8"
 Tapa para art. 732 - 782 Ø cm. 24 Ø 9 1/2"
 Ø cm. 26 Ø 10 1/4"
 Ø cm. 28 Ø 11"

701



10131140

mm. 1,2 Salsiera mod. "Aladino" cl. 10 oz. 3 3/8
 Gravy boat mod. "Aladino" cl. 15 oz. 5 1/8
 Saucière mod. "Aladino" cl. 30 oz. 10 1/8
 Sauciere mod. "Aladino"
 Salsera mod. "Aladino"
 Mestolino per salsa Lungn. cm. 18,7 Long. 7 3/8"
 Ladle for gravy boat
 Cuillère à sauce
 Saucenlöffel
 Cacillo para salsera

511



430511SS

mm. 0,8 Completo spargisale-portastecchi H cm. 14 H 5 1/2"
 Salt-cellar with toothpick container cl. 8 oz. 2 3/4
 Sel+poivre+porte cure-dents
 Salz+Pfeffer+Zahnstocherbehälter
 Saleros y pimentero y palillero

731



mm. 1,2 Zuppiera monoporzione demitasse Ø cm 12 Ø 4 3/4"
 Soup cup with base cl. 35 oz. 11 7/8
 Soupiere sur socle avec anses
 Suppentasse auf Fuss
 Taza para sopa con pedestal

772



mm. 0,8 Molla per ghiaccio
Ice tongs
Pince à glaçon
Eiszange
Pinzas hielo
Lungh. cm. 15,5
Length 6 1/8"

778



mm. 2,0 Molla per ghiaccio
Ice tongs
Pince à glaçon
Eiszange
Pinzas hielo
Lungh. cm. 18
Length 7 1/8"

382

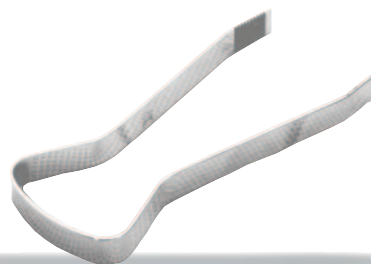

mm. 2,0 ERGONOMICA
Molla per ghiaccio
Ice tongs
Pince à glaçon
Eiszange
Pinzas hielo
Lungh. cm. 17
Length 6 5/8"

774



mm. 0,8 Molla per dolci
Pastry tongs
Pince à gateaux
Gebäckzange
Pinzas dulces
Lungh. cm. 19
Length 7 1/2"

777



mm. 0,8 Molla per spaghetti
Spaghetti/Pasta
tongs
Pince à spaghetti
Spaghettizange
Pinzas spaghetti
Lungh. cm. 21
Length 8 1/4"

775

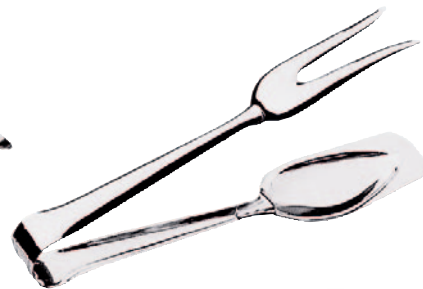

mm. 0,8 Molla per arrosto e verdure
Roasts and vegetables tongs
Pince à salade et à rôti
Servierzange
Pinzas asado y verduras
Lungh. cm. 21
Length 8 1/4"

779



mm. 0,8 Molla per lumache
Escargot tongs
Pince à escargots
Schneckenzange
Pinzas para caracoles
Lungh. cm. 16
Length 6 1/4"

771



mm. 0,8 Molla per zucchero
Sugar tongs
Pince à sucre
Zuckerzange
Pinzas azúcar
Lungh. cm. 14
Length 5 1/2"

752

741



mm. 0,8 Piattino per lumache Ø cm. 13,5-6pz. Ø 5 3/8" - 6pcs.
Escargot dish Ø cm. 18 - 12pz. Ø 7 1/8" - 12pcs.
Plat à escargots
Schneckenplatte
Plato caracoles

Molla per lumache Lungh. cm. 16 Length 6 1/4"
Tongs for snails
Pince à escargots
Schneckenzange
Pinzas para caracoles



mm. 0,8 Tegamino friggiuova Ø cm. 16 Ø 6 1/4"
Frying pan for eggs
Plat à oeuf
Eierpfanne
Plato huevos

904

911



mm. 1,2 Posacenere cm. 14 x 12 5 1/2" x 4 3/4"
Ash-tray
Cendrier
Ascher
Cenicero



mm. 0,6 Scodella lavadita Ø cm. 12 Ø 4 3/4"
Finger bowl cl. 30 oz. 10 1/8
Ecuelle
Fingerbowl
Lavadedos

956

528



mm. 1,2 Cloche copriburro o per antipasti Ø cm. 10,5 Ø 4 1/16"
Cloche for hors d'oeuvre or butter plate Ø cm. 13 Ø 5 1/16"
Cloche dome pour assiette
Cloche für Vorspeisen- oder Butterteller
Tapa para mantequera o para platos
por entremes



mm. 1,2 Formaggera ODEON cl. 20 oz. 6 3/4
Parmesan cheese basin »
Fromagère »
Käsedose »
Quesera-Azucarero »

998



Ø mm 8,0 Portabottiglia
Bottle stand
Porte-bouteille
Rotweinwiege
Portabotella

H cm. 23 H 9"
cm. 21 x 5,5 8 1/4" x 2 1/8"

711



mm. 0,6 Portauovo
Egg-cup
Coquetier
Eierbecher
Huevera

cm 15 x 9 5 7/8" x 3 1/2"

707



mm. 1,2 Portaburro
Butter dish
Beurrer
Butterdose mit Deckel
Mantequera
cm. 11 x 20
4 3/8" x 7 7/8"

799P



Ciotola quadra
Square bowl
Bol, carré
Universalschale auf Holz, quadr.
Cuenco cuadrado
cm. 6 x 6
2 3/8" x 2 3/8"

799W



TRE
"
"
"
"

799N



mm. 1,2 Ciotola per antipasto UNO
Snack bowl »
Bol à snacks »
Snackschale »
Cuenco por entremes »
Ø cm 9
Ø 3 1/2"

544

504



Ø cm. 19
H cm. 27
Ø 7 1/2"
H 10 5/8"

504

Ø mm. 6,0 Cestelli portacondimenti da tavola
Basket for aromatic condiments
Corbeilles pour condiments aromatiques
Tisch-Essig/Öl Flaschenhalter
Cestos para aromaticos y condimentos



cm. 17,5 x 16,5
H cm. 29,5
6 7/8" x 6 1/2"
H 11 3/5"

503



cm. 26 x 12
H cm. 28,5
10 1/4" x 4 3/4"
H 11 1/5"

356

mm. 1,2 Cestelli portacondimenti da buffet
Basket for aromatic condiments
Corbeilles pour condiments aromatiques
Buffet-Essig/Öl Flaschenhalter
Cestos para aromaticos y condimentos



355

cm. 12 x 6
H cm. 28,5

4 3/4" x 2 1/3"
H 11 1/5"

355

446

156

451

NEW



mm. 1,2	8 ¹ / ₂ Portatoast Toast rack Porte-toast Toastständer Portatostadas	cm. 21 x 7,5 8 1/4" x 3"	mm. 1,2	Portatoast Toast rack Porte-toast Toastständer Portatostadas	cm. 21 x 7,5 8 1/4" x 3"	mm. 1,2	Portatoast Toast rack Porte-toast Toastständer Portatostadas	cm. 21 x 7,5 8 1/4" x 3"
---------	---	-----------------------------	---------	--	-----------------------------	---------	--	-----------------------------

903

85303

901



Segnaposto Table number stand Numéro de table Tischnummern-Aufsteller Numero de mesa mm. 0,6	cm 11 x 9 4 3/8" x 3 1/2"	Segnaposto Table number stand Numéro de table Tischnummern-Aufsteller Numero de mesa mm. 3,0	H cm. 8 cm 8 x 8 H 3 1/8" 3 1/8" x 3 1/8"	Portanumero Table number stand Numéro de table Tischnummern-Ständer Numero de mesa mm. 0,6	cm. 9,5 x 5 Ø cm.10 H cm 10 3 3/4" x 2" Ø 4" H 4"
---	------------------------------	---	--	---	--

289

727



289

mm.1,2
Porta cono patatine GALA
Chips cone holder "
Porte pommes frites "
Eis-Kartoffenbehälter "
Porta cono patatas fritas "
Ø cm.6 - H cm. 10
Ø 2" - H 3 3/8"



726

mm.1,2
Coppa Martini
Martini Glass
Verre à Martini
Martini glas
Vaso para Martini
cl. 11 oz. 3 3/4
cl. 20 oz. 6 3/4



727

mm.1,2
Coppa per intermezzo
Intermezzo cup
Coupe à intermezzo
Sorbeteschale
Copa para intermezzo
cl. 4
oz. 1 3/8

152

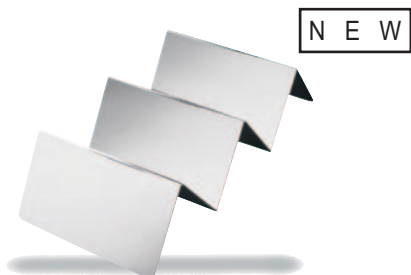

mm. 1,2 Porta tacos
Tacos Holder
Support pour tacos
Tacoshalter
Porta Tacos

cm 20 x 10 7 3/4" x 3 7/8"
H cm 5 H 2"

314



mm. 1,2 Vassoio concavo ERGONOMICA
Crescent tray »
Plateau concave »
Konkave Tablett »
Bandeja concavo »

cm 40 x 19 15 3/4" x 7 1/2"
cm 55 x 28 21 5/8" x 11"

232



mm. 1,2 Vassoio per self service
Cafeteria tray
Plateau pour self service
Tablett für self service
Bandeja para self service

cm. 40 x 30 15 3/4" x 11 7/8"

905



mm. 0,8 Portagrissini
Bread sticks holder
Porte gressin
Grissini-Halter
Porta bastoncillos de pan

Ø cm 10 Ø 3 7/8"
H cm. 17 H 6 5/8"

675



mm. 0,8 Portabottiglia antirollio per yacht
Yachting non-slip bottle holder
Cache eau minerale avec anneau antiderapant
Antiroll-Spezialflaschenhalter für Yachten
Portabotella antibalanco para yacht

Ø cm. 10
H cm. 17
Ø 3 7/8"
H 6 5/8"

496AC

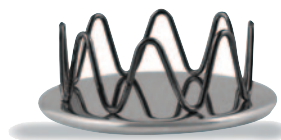

mm. 1,2 Salvagoccia bottiglia vino rosso Ø cm. 11,5 Ø 4 1/2"
Anti-drop wine bottle coaster
Dessous de bouteille de vin
anti-goutte
Tropfen einflaschenuntersetzer
Posabotella antigoteo por vino

280



mm. 1,2	Set per ceviche in acciaio inossidabile 18/10	607	607
	18/10 Stainless Steel ceviche set	Ø cm. 27	Ø 10 1/2"
	Set pour ceviche en acier inoxydable 18/10	H cm. 13,5	H 5 1/4"
	Cevicheset in Rostfreie Stahl 18/10	lt. 5	gal. 1 1/3
	Cevichera en acero inoxidable 18/10	58922	58922
		Ø cm. 22	Ø 8 1/2"
		H cm. 14	H 5 1/2"
		cl. 220	oz. 74 3/8

281



mm. 1,2	Set per ceviche in policarbonato	58928	58928
	Polycarbonate ceviche set	Ø cm. 28	Ø 11"
	Set pour ceviche en polycarbonate	H cm. 17,3	H 6 5/8"
	Cevicheset in Polikarbonat	lt. 6,03	oz. 202 1/2
	Cevichera en policarbonado	58922	58922
		Ø cm. 22	Ø 8 1/2"
		H cm. 14	H 5 1/2"
		cl. 220	oz. 74 3/8

994C



mm. 1,2	Portanumero piccolo	H cm. 7	H 2 3/4"
	Mini table number stand		
	Numbers etched to order		
	Mini marquer de table		
	Mini Tischnummernständer		
	Porta numero de mesa pequeño		

913



mm. 1,0	Porta badge in acciaio magnetico	cm. 8 x 4,5	3 1/7" x 1 3/4"
	Badge holder in magnetic steel		
	Porte-badge en acier magnétique		
	Badge-Halter in magnetischem Stahl		
	Porta tarjeta de acero magnético		

225



Cloche trasparente	Ø cm. 12	Ø 4 3/4"
Transparent cloche	Ø cm. 22	Ø 8 1/2"
Cloche transparente	Ø cm. 28	Ø 11"
Transparent Tellercloche		
Tapa transparente		

709



mm. 1,2	Portastuzzicadenti con base	Ø cm. 4	Ø 1 1/2"
	Toothpick container with base	H cm. 5,8	H 2 1/4"
	Porte-cure-dents avec socle	cl. 5	oz. 1 3/4
	Zahnstocherbehälter auf Fuss		
	Porta-palillos con base		

047



Colino da cocktail
Cocktail strainer
Passoire à cocktail
Cocktailsieb
Colador para coctelera

cm. 22 8 2/3"

049



Cavatappi
Cork screw / Bottle opener
Ouvre boîte - Ouvre-bouteilles
Korkenzieher
Abrebotellas

H cm. 19 H 7 1/2"

025



Grattugia
Grater
Râpe
Reibe
Rallador

cm. 23 9"

048

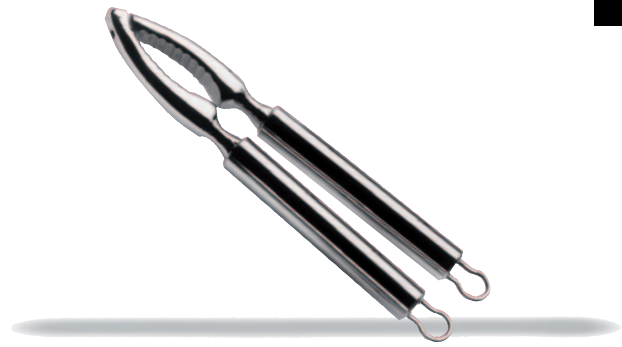

Schiaccianoci
Nutcracker
Casse noix
Nussknacker
Rompenueces

cm. 20 7 7/8"

473



ATTILA
Cavatappi
Cork screw / Bottle opener
Décapsuleur
Korkenheber
Abrebotellas

cm. 10 3 7/8"

mm. 1,2

10001108



Cucchiaino per caviale
Caviar spoon
Cuillère à caviar
Kaviarlöffel
Cucharita caviar

cm. 11,8 4 2/3"

447



JOKER
Macinapepe
Pepper mill
Moulin à poivre
Pfeffermühle
Molinillo de pimienta

Ø cm. 4 Ø 1 1/2"
H cm. 15 H 5 7/8"

464



ETNA
Macinasale
Salt mill
Moulin à sel
Salzmühle
Molinillo de sal

Ø cm. 4 Ø 1 1/2"
H cm. 15 H 5 7/8"

466



MANOLO
Macinapeperoncino
Chilli mill
Moulin à piment
Chilimühle
Molinillo de chile

Ø cm. 4 Ø 1 1/2"
H cm. 15 H 5 7/8"

462



PARDON
Tagliatartufi
Truffles slicer
Coupe truffes
Trüffel Hobel
Cortador de trufas

cm. 20 x 8 7 7/8" x 3 1/7"

104



mm. 1,2 EPOQUE
Sottopiatto e Sottobottiglia
Charger and Bottle coaster
Assiette de bienvenue et
Dessous de bouteille
Platz- und Flaschenteller
Bajo plato y Posabotella

Ø cm. 34 Ø 13 3/8"
Ø cm. 14,5 Ø 5 3/4"

133

671



mm. 1,0 Vasetto portafiori H. cm. 14 H. 5 1/2"
Flower vase
Vase à fleur
Blumenvase
Florero

757



mm. 1,2 ORCHIDEA
 Appoggia borse
 Bags support
 Soutier de sacs
 Beutelstand
 Apoya bolsas

cm. 30 x 40 11 7/8" x 15
 H cm. 30 3/4"
 H 11 7/8"

758



mm. 1,2 PEONIA
 Appoggia borse
 Bags support
 Soutier de sacs
 Beutelstand
 Apoya bolsas

cm. 37 x 31 14 5/8" x 12
 H cm. 33 1/4"
 H 13"

755



mm. 1,2 IRIS
 Appoggia borse
 Bags support
 Soutier de sacs
 Beutelstand
 Apoya bolsas

Ø cm. 35 Ø 13 3/4"
 H cm. 38 H 15"

756



mm. 1,2 BIANCOSPINO
 Appoggia borse
 Bags support
 Soutier de sacs
 Beutelstand
 Apoya bolsas

Ø cm. 37 Ø 14 5/8"
 H cm. 37 H 14 5/8"





Tea Time

94003

976S



976C



mm. 1,2 Servizio per zucchero
Sugar set
Service pour sucre
Zucker Menage
Juego azucar

cl. 15 (x3) oz. 5 1/8 (x3)
cl. 15 (x4) oz. 5 1/8 (x4)

mm. 1,2 Portasalatini impilabile
Stackable snack server
Support à snack empilable
Stapelbare Relish-Pickles-Gestell
Servicio por entremes impilable

Ø cm. 20 Ø 7 7/8"
cl. 15 (x3) oz. 5 1/8 (x3)

976C Ø cm. 20 Ø 7 7/8"
H cm 15 H 5 7/8"
cl. 15 (x3) oz. 5 1/8 (x3)

984

974

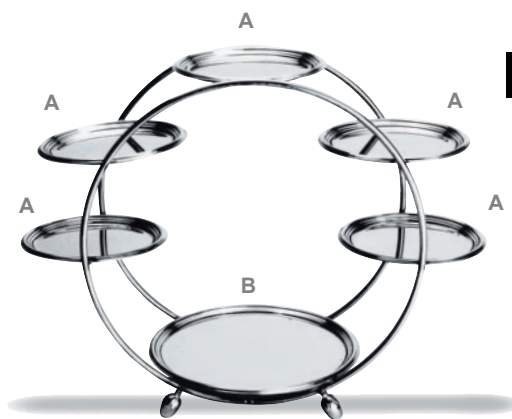
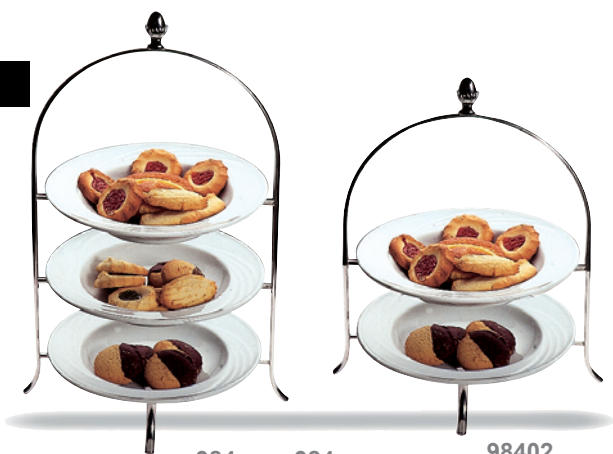

Alzata portapiatti
Afternoon tea stand
Présentoir à gateau
Dessert-Serviergestell
Soporte platos

984 Ø cm 22
H.cm.45
985 Ø cm 18
H.cm.33
989 Ø cm 30
H.cm.52

984 Ø 8 3/16"
H 17 1/4"
985 Ø 7 1/8"
H 13"
989 Ø 11 3/4"
H 20 1/2"

98402 Ø cm 22 Ø 8 3/16"
H cm.35 H 13 3/4"

mm. 1,2 Presentoir
2 misure
2 sizes
2 tailles
2 Größen
2 tamaños

A Ø cm.13 (x5) A Ø 5 1/8" (x5)
B Ø cm.19 B Ø 7 1/2"
A Ø cm.19 (x5) A Ø 7 1/2" (x5)
B Ø cm.27 B Ø 10 5/8"



257



Porta pasticcini c/pied.
Petit-fours stand with base
Porte-petits-fours a/socle
Petits Fours-Ständer
Porta dulces con pedestal

Ø cm. 14 Ø 5 1/2"
H cm. 8,7 H 3 1/2"
Ø cm. 20 Ø 7 7/8"
H cm. 13 H 5 1/8"
Ø cm. 28 Ø 11"
H cm. 14,5 H 5 3/4"

mm. 1,2

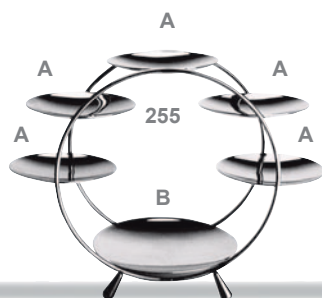

Presentoire
2 mesure
2 sizes
2 tailles
2 Größen
2 tamaños
mm. 1,2

25506
A Ø cm. 6 (x5)
B Ø cm. 7,5
H cm. 13
25508
A Ø cm. 7,5 (x5)
B Ø cm. 11
H cm. 17

25506
A Ø 2 2/5" (x5)
B Ø 3"
H 5 1/8"
25508
A Ø 3" (x5)
B Ø 4 1/3"
H 6 5/8"

258



Porta pasticcini c/pied.
Petit-fours stand w/base
Porte-petits-fours a/socle
Petits Fours-Ständer
Porta dulces c/pedestal

Ø cm. 14
Ø cm. 20
Ø cm. 28
H cm. 27
Ø 5 1/2"
Ø 7 7/8"
Ø 11"
H 10 5/8"

mm. 1,2

721



Coppa termica con cloche
Insulated cup with cloche
Coupe thermique avec cloche
Isolier-Eisfruchtbecher mit Deckel
Copa térmica con tapa

Ø cm. 8,5
cl. 15
Ø 3 3/4"
oz. 5 1/8

mm. 1,2

451



Portatoast
Toast rack
Porte-toast
Toastständer
Portatostadas

cm. 21 x 7,5
8 1/4" x 3"

mm. 1,2

935



Porta macaron
Macarons server
Porte macarons
Macaronsträger
Porta macaron

Ø cm 15
H cm 10
Ø 5 7/8"
H 4"

mm. 1,2

702



Mini burriera con coperchio
Small butter dish w/lid
Petit beurrier a/couvercle
Mini Butterdose m/Deckel
Platillo para mantequilla c/tapa

cm. 12 x 6
cl. 15
4 3/4" x 2 1/3"
oz. 5 1/8

mm. 1,2

526

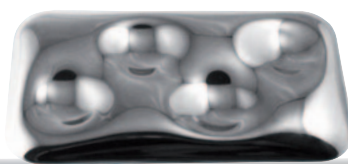

Vassoio rett. a 4 comp.
Rectang. tray 4 comp.
Plateau rect. ou 4 plac.
Tablett, rech. 4 Eins.
Bandeja rect. 4 posic.

mm. 1,2

cm. 23 x 13
9" x 5 1/8"

524



Set cremiera Koji 5pz c/vass.
Cream set Koji 5 pcs w/tray
Set à crème Koji 5 pcs a/plat.
Sahne Set 5-Tlg. Koji m/Tab.
Servicio leche Koji 5pzs. c/band.

mm. 1,2

cm. 12 x 12
cl. 25
4 3/4" x 4 3/4"
oz. 8 2/5

265



Vassoio per pasticceria
Patisserie tray
Plateau pour patisserie
Patisserie Tablett
Bandeja para pasteleria

cm. 24,5 x 17
cm. 30 x 21
cm. 34 x 24
9 5/8" x 6 3/4"
11 3/4" x 8 1/4"
13 3/8" x 9 1/2"

mm. 1,2

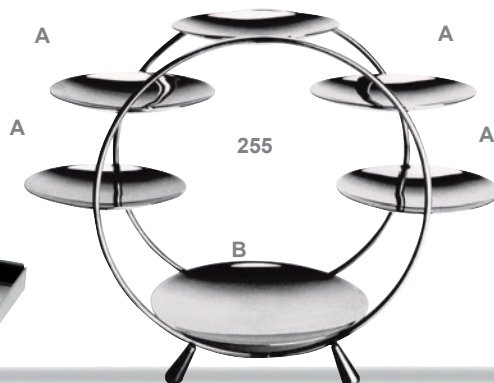

Presentoire
3 misure
3 sizes
3 tailles
3 Größen
3 tamaños
mm. 1,2

25514
A Ø cm.14 (x5)
B Ø cm.20
H cm. 30
25520
A Ø cm.20 (x5)
B Ø cm.24
H cm. 30
25524
A Ø cm.24 (x5)
B Ø cm.28
H cm. 41

25514
A Ø 5 1/2" (x5)
B Ø 7 7/8"
H 11 3/4"
25520
A Ø 7 7/8" (x5)
B Ø 9 1/2"
H 11 3/4"
25524
A Ø 9 1/2" (x5)
B Ø 11"
H 16 3/5"

205



Vassoio per pasticceria con piedistallo
Patisserie tray with foot
Plateau pour patisserie avec socle
Patisserie Tablett mit Fuss
Bandeja para pasteleria con pies

cm. 26 x 12
cm. 60 x 12
H cm. 13
10 1/4" x 4 3/4"
23 3/5" x 10 1/5"
H 5 1/9"

mm. 1,2

206

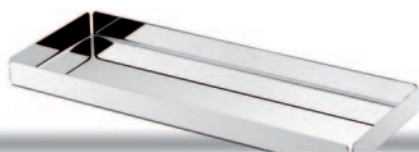

Vassoio per pasticceria
Patisserie tray
Plateau pour patisserie
Patisserie Tablett
Bandeja para pasteleria

cm. 26 x 12
cm. 60 x 12
10 1/4" x 4 3/4"
23 3/5" x 10 1/5"

mm. 1,2



Portabustine da zucchero
Sugar packet holder
Pot à sucre
Zuckerstangengefäß
Azucarera

mm. 1,2



516
cm. 10 x 7
H cm. 3
516
4" x 2 3/4"
H 1 1/8"
51610
cm. 10 x 5
H cm. 4,5
51610
4" x 2"
H 1 3/4"

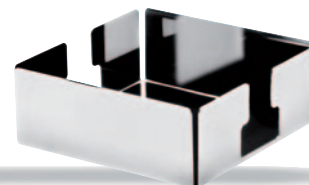

Portatovaglioli
Napkin holder
Distributeur de serviettes
Serviettenhalter
Portaservilletas

cm. 13 x 13
5 1/9" x 5 1/9"

mm. 1,2

704





Caffè

621



mm. 1,2	Caffettiera con piedistallo	Tazze	1	cl. 15	5 1/8 oz.
	Coffee pot with base	Cups	2	cl. 27	9 1/8 oz.
	Cafetière avec socle	Bols	4	cl. 37	12 1/2 oz.
	Kaffeekanne auf Fuss	Tassen	6	cl. 55	18 1/8 oz.
	Cafetera con pedestal	Tazas	8	cl. 85	28 1/4 oz.
			10	cl. 110	37 1/4 oz.
			12	cl. 150	50 1/4 oz.
		16	cl. 200	67 1/8 oz.	

622



mm. 1,2	Teiera con piedistallo	Tazze	2	cl. 35	11 7/8 oz.
	Tea pot with base	Cups	4	cl. 50	16 7/8 oz.
	Théière avec socle	Bols	6	cl. 70	23 1/8 oz.
	Teekanne auf Fuss	Tassen	8	cl. 95	32 1/8 oz.
	Tetera con pedestal	Tazas	10	cl. 120	40 7/8 oz.

623



mm. 1,2	Lattiera con piedistallo	Tazze	1	cl. 15	5 1/8 oz.
	Milk jug with base	Cups	2	cl. 27	9 1/8 oz.
	Pot à lait avec socle	Bols	4	cl. 37	12 1/2 oz.
	Milchkanne auf Fuss	Tassen	6	cl. 55	18 1/8 oz.
	Jarra lechera con pedestal	Tazas	8	cl. 85	28 1/4 oz.
			10	cl. 110	37 1/4 oz.
			12	cl. 150	50 1/4 oz.
		16	cl. 200	67 1/8 oz.	

624



mm. 1,2	Zuccheriera con piedistallo	Tazze	2	cl. 15	5 1/8 oz.
	Sugar bowl with base	Cups	4	cl. 20	6 3/4 oz.
	Sucrier avec socle	Bols	6	cl. 27	9 1/8 oz.
	Zuckerdose auf Fuss	Tassen	8	cl. 35	11 1/8 oz.
	Azucarero con pedestal	Tazas			



624P

646



mm. 1,2	Caffettiera termica con piedistallo	Tazze	4	cl. 30	10 1/8 oz.
	Insulated coffee pot with base	Cups	6	cl. 60	20 1/4 oz.
	Cafetière thermique avec socle	Bols	12	cl. 150	50 1/4 oz.
	Isolier-Kaffeekanne auf Fuß	Tassen			
	Cafetera térmica con pedestal	Tazas			

648



mm. 1,2	Caraffa termica c/fermaghiaccio e piedistallo			cl. 150
	Insulated water pitcher w/ice-trap and base			
	Carafe à eau avec attrape-glace et socle			
	Isolier-Wasserkrug auf Fuss			50 1/4 oz.
	Jarra agua c/tope y pedestal			

641



mm. 1,2	Caffettiera	Tazze	1 cl. 15	5 1/8 oz.
	Coffee pot	Cups	2 cl. 27	9 1/8 oz.
	Cafetière	Bols	4 cl. 37	12 1/2 oz.
	Kaffeekanne	Tassen	6 cl. 55	18 1/8 oz.
	Cafetera	Tazas	8 cl. 85	28 1/4 oz.
			10 cl. 110	37 1/4 oz.
			12 cl. 150	50 1/4 oz.
			16 cl. 200	67 1/8 oz.

642



mm. 1,2	Teiera	Tazze	1 cl. 20	6 1/4 oz.
	Tea pot	Cups	2 cl. 35	11 1/8 oz.
	Théière	Bols	4 cl. 50	16 1/8 oz.
	Teekanne	Tassen	6 cl. 70	23 1/8 oz.
	Tetera	Tazas	8 cl. 95	32 1/8 oz.
			10 cl. 120	40 1/8 oz.

643



mm. 1,2	Lattiera	Tazze	1/2 cl. 10	3 1/8 oz.
	Milk jug	Cups	1 cl. 15	5 1/8 oz.
	Pot à lait	Bols	2 cl. 27	9 1/8 oz.
	Milchkanne	Tassen	4 cl. 37	12 1/2 oz.
	Jarra lechera	Tazas	6 cl. 55	18 1/8 oz.
			8 cl. 85	28 1/4 oz.
			10 cl. 110	37 1/4 oz.
			12 cl. 150	50 1/4 oz.
			16 cl. 200	67 1/8 oz.

644



644P

mm. 1,2	Zuccheriera	Tazze	2 cl. 15	5 1/8 oz.
	Sugar bowl	Cups	4 cl. 20	6 1/4 oz.
	Sucrier	Bols	6 cl. 27	9 1/8 oz.
	Zuckerdose	Tassen	8 cl. 35	11 1/8 oz.
	Azucarero	Tazas		

647



mm. 1,2	Caraffa termica per acqua c/fermaghiaccio	cl. 150
	Insulated water pitcher w/ice-trap	
	Carafe à eau avec attrape-glace	
	Isolier-Wasserkrug	50 1/4 oz.
	Jarra agua c/tope	

645



mm. 1,2	Caffettiera termica	Tazze	4 cl. 30	10 1/8 oz.
	Insulated coffee pot	Cups	6 cl. 60	20 1/4 oz.
	Cafetière thermique	Bols	12 cl. 150	50 1/4 oz.
	Isolier-Kaffeekanne	Tassen		
	Cafetera térmica	Tazas		

940



mm. 1,2 Servizio per caffè macchiato
Café au lait set
Service pour café au lait
Café au lait-Set
Juego café au lait

939
H cm 18
cl. 90

940
H cm 18
cl. 97

939
H 7 1/8"
oz. 30 1/2

940
H 7 1/8"
oz. 32 7/8

940E
Inserto per art. 940
Insert for art. 940
Insért pour art. 940
Einsatz für Art. 940
Inserto por art. 940

940E



mm. 1,2 Servizio per caffè macchiato
5pcs Sugar, milk and coffee set
Service sucre, lait et café 5 pièces
Milch-Kaffee-Zucker Set 5-Tlg.
Juego leche, café y azucar 5 piezas

H cm 18 H 7 1/8"
cl. 30 (x5) oz. 10 1/8 (x5)

94005



94003



mm. 1,2 Servizio per zucchero 3 pezzi
Sugar set 3 pcs.
Service pour sucre 3 pièces
Zucker Menage 3-Tlg
Juego azucar 3 piezas

cl. 11 (x3) oz. 3 3/4 (x3)

94004



mm. 1,2 Servizio per zucchero 4 pezzi
Sugar set 4 pcs.
Service pour sucre 4 pièces
Sahne-/Zucker-Set 4-Tlg
Juego azucar 4 piezas

cl. 11 (x4) oz. 3 3/4 (x4)

649



mm. 1,2 Bricco
Jug
Cruche
Milchkännchen
Jarra

BOMBATA cl. 20

oz. 6 3/4

639



mm. 1,2 Bricco
Jug
Cruche
Milchkännchen
Jarra

BOMBATA cl. 20

oz. 6 3/4

631



mm. 1,2	Caffettiera	Tazze	2 cl. 24	8 1/8 oz.
	Coffee pot	Cups	4 cl. 34	11 1/2 oz.
	Cafetière	Bols	6 cl. 46	15 1/2 oz.
	Kaffeekanne	Tassen	8 cl. 63	21 1/8 oz.
	Cafetera	Tazas	10 cl. 100	33 1/8 oz.
			12 cl. 150	50 1/4 oz.
		16 cl. 200	67 1/8 oz.	

632



mm. 1,2	Teiera	Tazze	2 cl. 40	13 1/2 oz.
	Tea pot	Cups	4 cl. 50	16 1/8 oz.
	Théière	Bols	6 cl. 68	23 oz.
	Teekanne	Tassen	8 cl. 90	30 1/2 oz.
	Tetera	Tazas		

633



mm. 1,2	Lattiera	Tazze	1 cl. 10	3 1/8 oz.
	Milk jug	Cups	2 cl. 24	8 1/8 oz.
	Pot à lait	Bols	4 cl. 34	11 1/2 oz.
	Milchkanne	Tassen	6 cl. 46	15 1/2 oz.
	Jarra lechera	Tazas	8 cl. 63	21 1/4 oz.
			10 cl. 100	33 1/8 oz.
			12 cl. 150	50 1/4 oz.
			16 cl. 200	67 1/8 oz.

634



mm. 1,2	Zuccheriera	Tazze	4 cl. 15	5 1/8 oz.
	Sugar bowl	Cups	6 cl. 22	7 1/2 oz.
	Sucrier	Bols	8 cl. 28	9 1/2 oz.
	Zuckerdose	Tassen		
	Azucarero	Tazas		

635



mm. 1,2	Brocca per acqua con fermagliaccio	cl. 100
	Water pitcher with ice-trap	cl. 200
	Carafe à eau avec attrape-glace	33 1/5 oz.
	Eiswaserkrug	67 1/3 oz.
Jarra agua c/topo		

651



mm. 1,2

Caffettiera	Tazze	2	cl. 25	8 1/2 oz.
Coffee pot	Cups	4	cl. 37	12 1/2 oz.
Cafetière	Bols	6	cl. 52	17 1/8 oz.
Kaffeekanne	Tassen	8	cl. 70	23 1/8 oz.
Cafetera	Tazas	10	cl. 100	33 1/8 oz.
		12	cl. 150	50 1/4 oz.
		16	cl. 200	67 1/8 oz.

652



mm. 1,2

Teiera	Tazze	2	cl. 40	13 1/2 oz.
Tea pot	Cups	4	cl. 55	18 1/8 oz.
Théière	Bols	6	cl. 70	23 1/8 oz.
Teekanne	Tassen	8	cl. 97	32 1/4 oz.
Tetera	Tazas			

653



mm. 1,2

Lattiera	Tazze	1	cl. 10	3 1/8 oz.
Milk jug	Cups	2	cl. 25	8 1/2 oz.
Pot à lait	Bols	4	cl. 37	12 1/2 oz.
Milchkanne	Tassen	6	cl. 52	17 1/8 oz.
Jarra lechera	Tazas	8	cl. 70	23 1/8 oz.
		10	cl. 100	33 1/8 oz.
		12	cl. 150	50 1/4 oz.
		16	cl. 200	67 1/8 oz.

654



mm. 1,2

Zuccheriera	Tazze	2	cl. 13	4 1/8 oz.
Sugar bowl	Cups	4	cl. 18	6 1/8 oz.
Sucrier	Bols	6	cl. 22	7 1/2 oz.
Zuckerdose	Tassen	8	cl. 30	10 1/8 oz.
Azucarero	Tazas			

160



mm. 1,2

Caffettiera
Coffee pot
Cafetière
Kaffeekanne
Cafetera

Tazze 2 cl. 24
Cups 4 cl. 34
Bols 10 cl. 100
Tassen 12 cl. 150
Tazas

8 1/8 oz.
11 1/2 oz.
33 1/8 oz.
50 1/4 oz.

161



mm. 1,2

Teiera
Tea pot
Théière
Teekanne
Tetera

Tazze 4 cl. 50
Cups 6 cl. 68
Bols
Tassen
Tazas

16 1/8 oz.
23 oz.

162



mm. 1,2

Lattiera
Milk jug
Pot à lait
Milchkanne
Jarra lechera

Tazze 1 cl. 10
Cups 2 cl. 24
Bols 6 cl. 46
Tassen
Tazas

3 1/8 oz.
8 1/8 oz.
15 1/2 oz.

163



mm. 1,2

Zuccheriera
Sugar bowl
Sucrier
Zuckerdose
Azucarero

Tazze 6 cl. 22
Cups
Bols
Tassen
Tazas

7 1/2 oz.

189



mm. 1,2

Brocca per acqua con fermagliaccio
Water pitcher with ice-trap
Carafe à eau avec attrape-glace
Eiswaserkrug
Jarra agua c/tope

cl. 100
cl. 200

33 1/5 oz.
67 1/3 oz.



411



mm. 1,2
Caffetteria
Coffee pot
Cafetière
Kaffeekanne
Cafetera

Tazze	2	cl. 25	8 1/2 oz.
Cups	4	cl. 37	12 1/2 oz.
Bols	6	cl. 52	17 5/8 oz.
Tassen	8	cl. 70	23 5/8 oz.
Tazas	10	cl. 100	33 7/8 oz.
	12	cl. 150	50 3/4 oz.
	16	cl. 200	67 5/8 oz.

412



mm. 1,2
Teiera
Tea pot
Théière
Teekanne
Tetera

Tazze	4	cl. 55	18 5/8 oz.
Cups	6	cl. 70	23 5/8 oz.
Bols	8	cl. 97	32 1/4 oz.
Tassen			
Tazas			

413



mm. 1,2
Lattiera
Milk jug
Pot à lait
Milchkanne
Jarra lechera

Tazze	1	cl. 10	3 5/8 oz.
Cups	2	cl. 25	8 1/2 oz.
Bols	4	cl. 37	12 1/2 oz.
Tassen	6	cl. 52	17 5/8 oz.
Tazas	8	cl. 70	23 5/8 oz.
	10	cl. 100	33 7/8 oz.
	12	cl. 150	50 3/4 oz.
	16	cl. 200	67 5/8 oz.

414



mm. 1,2
Zuccheriera
Sugar bowl
Sucrier
Zuckerdose
Azucarero

Tazze	4	cl. 18	6 1/8 oz.
Cups	8	cl. 30	10 1/8 oz.
Bols			
Tassen			
Tazas			

361



mm. 1,2
Caffettiera
Coffee pot
Cafetière
Kaffeekanne
Cafetera

Tazze	1	cl. 10	3 7/8 oz.
Cups	4	cl. 34	11 1/2 oz.
Bols	6	cl. 50	16 7/8 oz.
Tassen	8	cl. 75	25 3/8 oz.
Tazas	10	cl. 97	32 1/5 oz.
	16	cl. 200	67 3/8 oz.

362



mm. 1,2
Teiera
Tea pot
Théière
Teekanne
Tetera

Tazze	2	cl. 35	11 7/8 oz.
Cups	4	cl. 50	16 7/8 oz.
Bols	6	cl. 75	25 3/8 oz.
Tassen	8	cl. 97	32 1/5 oz.
Tazas			

363



mm. 1,2
Lattiera
Milk jug
Pot à lait
Milchkanne
Jarra lechera

Tazze	1	cl. 10	3 7/8 oz.
Cups	4	cl. 34	11 1/2 oz.
Bols	6	cl. 52	17 3/8 oz.
Tassen	8	cl. 75	25 3/8 oz.
Tazas	16	cl. 200	67 3/8 oz.

364



mm. 1,2
Zuccheriera porta bustine
Sugar packets holder
Sucrier à sachets
Zuckerdose/Zuckerstangengefäß
Azucarera

364T	cl. 22	7 1/2 oz.
364A	cl. 22	7 1/2 oz.
364B	cl. 10	3 3/8 oz.

366



mm. 1,2
Caffettiera termica
Insulated coffee pot
Cafetière thermique
Isolier-Kaffeekanne
Cafetera térmica

Tazze	6	cl. 50
Cups	8	cl. 75
Bols		
Tassen		16 7/8 oz.
Tazas		25 3/8 oz.

367



mm. 1,2
Teiera termica
Insulated tea pot
Théière thermique
Isolier-Teekanne
Tetera térmica

Tazze	4	cl. 50
Cups	6	cl. 75
Bols		
Tassen		16 7/8 oz.
Tazas		25 3/8 oz.



516



mm. 1,2 Portabustine da zucchero
Sugar packet holder
Pot à sucre
Zuckerstangengefäß
Azucarera

cm. 10 x 7 4" x 2 3/4"
H cm. 3 H 1 1/8"

206



mm. 1,2 Vassoio per pasticceria
Pâtisserie tray
Plateau pour pâtisserie
Pâtisserie Tablett
Bandeja para pasteleria

cm. 26 x 12 10 1/4" x 4 3/4"
cm. 60 x 12 23 3/5" x 10 1/5"

136



mm. 1,2 Vassoio CAFE' VIENNA cm. 26 x 19 10 1/4" x 7 1/2"
Tray »
Plateau »
Kaffeetablett »
Bandeja »

704

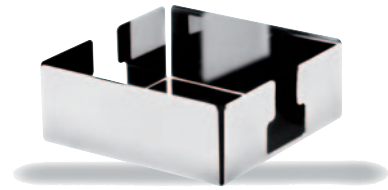

mm. 1,2 Portatovaglioli
Napkin holder
Distributeur de serviettes
Serviettenhalter
Portaservilletas

cm. 13 x 13 5 1/9" x 5 1/9"

902



mm. 1,2 Portabastoncini da zucchero
Sugar bags holder
Pot à sucre
Zuckerstangengefäß
Azucarera

Ø cm 7 H 3 1/4"
H cm 8 Ø 2 3/4"
cl. 37 oz. 12 1/2

700



mm. 1,2 Zuccheriera
Sugar container
Sucriere
Zuckerdose
Azucarero

Ø cm 10 Ø 4"
cl.35 oz 11 1/8

594



mm. 1,2 Cremlera con piedistallo UNO cl.16 oz. 5³/₈
 Cream jug with base »
 Crémier avec socle »
 Sahnegießer/Milchkännchen »
 Jarrita lechera con pedestal »

595



mm. 1,2 Zuccheriera con piedistallo UNO cl. 24 oz. 8¹/₈
 Sugar bowl with base »
 Sucrier avec socle »
 Zuckerdose auf Fuss »
 Azucarero con pedestal »

499



mm. 1,2 MINIMA cm.15 x 11 5¹/₈" x 4³/₈"
 Portabustine da zucchero 4 sc. H.cm.14 H. 5¹/₂"
 Sugar packets holder 4 compt.
 Pot à sucre 4 comp.
 Zuckerstangengefäß 4 Eins.
 Azucarera 4 comp.

706



mm. 1,2 Porta salviette lavamani cm. 15 x 9 5⁷/₈" x 3¹/₂"
 Tray for hand towels
 Plateau porte serviettes
 Tablett für Stoffservietten
 Bandeja portaservilletas

703



10201144
 Lungh. cm. 16,5
 Length 6¹/₂"

mm.1,2 Set per latte macchiato Ø cm. 10 Ø 3⁷/₈"
 Latte Macchiato Set cl. 36 oz. 12³/₈
 Service pour Latte Macchiato
 Latte Macchiato-Set
 Servicio para café con leche

720



mm. 1,2 Portaburro e marmellata cm. 17,5 x 7,5 6⁷/₈" x 3"
 Butter and jam dish
 Beurre et confiture
 Butter-Marmeladen-Platte
 Porta mantequilla y mermelada

Bar



661

941

665



Portacucchiaini per bar Ø cm. 9 Ø 3 1/4"
Coffee spoons stand
Pot à cuillères pour bar
Löffelbecher
Porta-cucharitas para bar
mm. 0,8

Secchiello per spumante Ø cm. 18 Ø 7 1/4"
Sparkling wine cooler H cm. 18,5 H 7 1/8"
Seau à champagne lt. 4 gal. 1
Wein-und Sektkühler
Cubo para champany
mm. 1,2

Secchiello per ghiaccio Ø cm. 13,5 Ø 5 1/8"
Ice-bucket with knobs H cm. 13 H 5 1/8"
Seau à glaçons cl. 150 oz. 50 1/4
Eisgefäß
Cubitera hielo
mm. 0,8

708

545



mm. 1,2 Piattino portamonete
Cash tray
Plat à addition
Zahlteller
Bandeja porta monedas

cm. 11 x 15 4 1/8" x 5 1/8"

mm. 1,2 Dosatore
Jigger
Doseur
Barmaß
Medida

cl. 2 e 4 oz. 1
oz. 1 1/8

Agitatore cl. 25 oz. 8 1/2
Shaker cl. 50 oz. 16 1/8
Shaker cl. 75 oz. 25 1/8
Shaker
Coctelera

729

551



mm. 1,2 Coppa per punch Ø cm. 38
Punch bowl lt. 15
Bol à punch
Punchbowl Ø 15"
Cazo ponche 4 gal.

Mestolo coppa per punch
Punch bowl ladle
Cuiller à punch
Bowlenlöffel
Cazo ponche

mm. 0,8

Agitatore Boston con bicchiere
Boston shaker
Boston shaker à cocktail et verre
Boston Shaker
Coctelera Boston

cl. 75 oz. 25 1/8

Colori disponibili a pag. 344
Available colors at page 344
Couleurs disponibles
à page 344
Sehen Sie erhaltlichen Farben
an Seite 344
Ver colores à pagina 344

972

973



mm. 1,2
972-972P
 PALACE
 Secchiello per ghiaccio
 Ice bucket
 Seau à glaçons
 Eisgefäß
 Cubitera hielo

Ø cm 15 Ø 5 1/8"
 H cm 18 H 7 1/8"
 cl.150 oz. 50 3/4

mm. 1,2
973-973P
 PALACE
 Secchiello per spumante
 Sparkling wine cooler
 Seau à champagne
 Wein- und Sektkühler
 Cubo para champany

Ø cm 20,5 Ø 8 1/8"
 H cm 24,5 H 9 5/8"
 lt. 5,0 gal. 1 1/3

666F

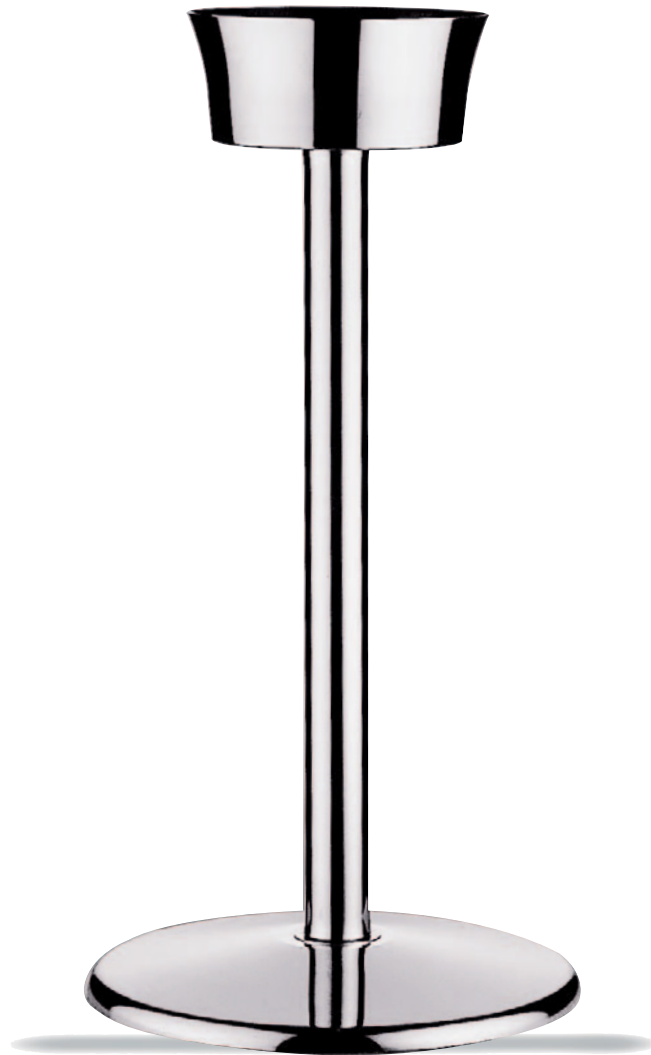

mm. 1,2
PALACE
 Colonna portasecchiello spumante
 Wine cooler stand w/weighted base
 Pied pour seau à champagne
 Weinkühlerständer
 Columna porta cubo champany

H cm. 67,5 H 26 5/8"

370



mm. 1,2 IMMAGINA
 Secchiello per spumante
 Sparkling wine cooler
 Seau à champagne
 Wein- und Sektkühler
 Cubo para champany

cm 27 x 20,5 10 3/8" x 8"
 H cm 21,5 H 8 1/2"
 lt. 6,5 gal. 1 3/4

371



mm. 1,2 IMMAGINA
 Secchiello per ghiaccio
 Ice bucket
 Seau à glaçons
 Eisgefäß
 Cubitera para hielo

cm 16,6 x 10 6 1/2" x 4"
 H cm 14,2 H 8 1/2"
 cl. 180 oz. 60 7/8

666H



mm. 1,2 IMMAGINA
 Colonna portasecchiello spumante
 Wine cooler stand
 Pied pour seau à champagne
 Weinkühlerständer
 Columna porta cubo champany

H cm. 61,5 H 24 1/5"

670



670 mm. 1,2
 Secchiello per ghiaccio
 Ice bucket with grill
 Seau à glaçons
 Eisgefäß
 Cubitera hielo
 Ø cm. 14 - H cm. 13 - cl. 150
 Ø 5 1/2" - H 5 1/8" - oz. 50 3/4



662 mm. 1,2
 Rinfrescavino bianco da 1 bottiglia
 White wine cooler for 1 bottle
 Seau à vin blanc
 Weissweinkühler für 1 Flasche
 Cubo para refrescar 1 botella de vino blanco
 Ø cm. 16 - H cm. 20 - lt. 3
 Ø 6 1/4" - H 7 7/8" - oz. 101 1/2



663 mm. 1,2
 Rinfrescavino spumante da 1 bottiglia
 Sparkling wine cooler for 1 bottle
 Seau à Champagne 1 bouteille
 Champagnerkühler für 1 Flasche
 Cubo para refrescar 1 botella de vino spum.
 Ø cm. 18 - H cm. 21 - lt. 4,5
 Ø 7 1/8" - H 8 1/4" - gal. 1 1/4



664

664 mm. 1,2
 Rinfrescavino spumante da 2/3 bottiglie o Magnum
 Sparkling wine cooler for 2/3 bottles or Magnum
 Seau à champagne 2/3 bouteilles ou Magnum
 Champagnerkühler für 2/3 Flaschen oder Magnum
 Cubo para refrescar 2/3 botellas de vino spumante
 Ø cm. 22,5 - H cm. 23 - lt. 8,5
 Ø 8 7/8" - H 9" - gal. 2 1/4

666

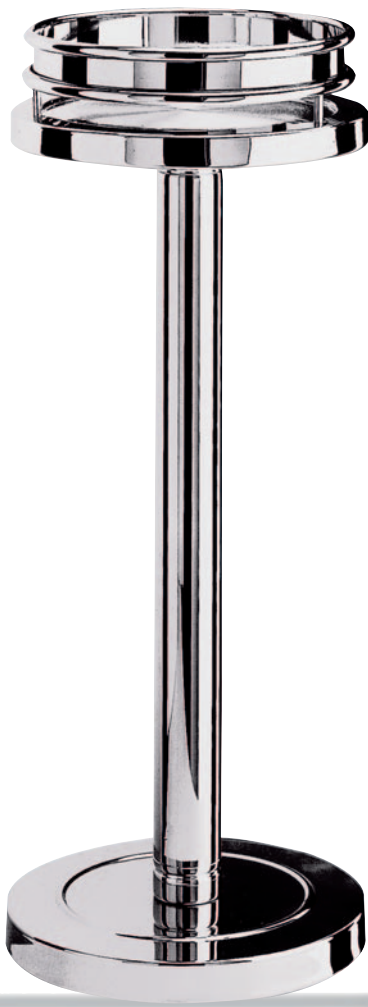

mm. 1,2
 Colonna portasecchiello spumante H cm. 65 H 25 5/8"
 Wine cooler stand
 Pied pour seau à champagne
 Weinkühlerständer
 Columna porta cubo champany

67704



mm. 0,8
 Portaghiaccio termico con coperchio
 Insulated ice-bucket with lid
 Seau à glaçon thermique avec couvercle
 Isolier-Eisgefäß
 Cubitera hielo con tapa
 lt. 3/4
 lt. 4
 oz. 25 3/8
 gal. 1

676



mm. 0,8
 Glacette termica per 1 bottiglia
 Insulated glacette for 1 bottle
 Glacette thermique pour 1 bouteille
 Getränke Kühler 1 Flasche
 Cubo térmico para 1 botella
 Ø Int. cm. 10,3
 Ø Est cm. 14,5
 H cm. 21,5
 cl. 150
 Int. Ø 4"
 Out. Ø 5 5/7"
 H 8 3/5"
 oz. 50 3/4

681

678



681 mm.1,2
MICHELANGELO
 Rinfrescavino spumante da 2/3 bottiglie o Magnum
 Sparkling wine cooler for 2/3 bottles or Magnum
 Seau à champagne 2/3 bouteilles ou Magnum
 Champagnerkühler für 2/3 Flaschen oder Magnum
 Cubo para refrescar 2/3 botellas de vino spumante
 Ø cm.22,5 - H cm.23 - lt. 8,5
 Ø 8 7/8" - H 9" - gal. 2 1/4

680 mm.1,2
MICHELANGELO
 Rinfrescavino spumante da 1 bottiglia
 Sparkling wine cooler for 1 bottle
 Seau à champagne 1 bouteille
 Champagnerkühler für 1 Flasche
 Cubo para refrescar 1 botella de vino spum.
 Ø cm.18 - H cm.21 - lt. 4,5
 Ø 7 1/8" - H 8 1/4" - gal. 1 1/4

679 mm.1,2
MICHELANGELO
 Rinfrescavino bianco da 1 bottiglia
 White wine cooler for 1 bottle
 Seau à vin blanc
 Weissweinkühler für 1 Flasche
 Cubo para refrescar 1 botella de vino blanco
 Ø cm.16 - H cm.20 - lt. 3
 Ø 6 1/4" - H 7 7/8" - oz. 10 1/2

678 mm.1,2
MICHELANGELO
 Secchiello per ghiaccio
 Ice bucket with grill
 Seau à glaçons
 Eisgefäß
 Cubitera hielo
 Ø cm.14 - H cm.13 - cl. 150
 Ø 5 1/2" - H 5 1/8" - oz. 50 3/4

672

666A



mm. 1,2 Portaggiaccio termico con anello e molla
 Insulated ice-bucket with handle and tongs for ice
 Seau à glaçon thermique avec anse et pinçe
 Isolier-Eisgefäß und Eiszange
 Cubitera hielo con asa y pinzas hielo
 lt. 3/4 oz. 25 3/8

660



mm. 0,8 Servizio per champagne
 Insulated Champagne set
 Service pour champagne
 Champagnergetränk Kühler
 Servicio para champagne
 Ø cm. 26
 H cm. 22
 cl. 150
 Ø 10 1/4"
 H 8 2/3"
 oz. 50 3/4



mm. 1,2 GALA
 Colonna portasecchiello spumante
 Wine cooler stand
 Pied pour seau à champagne
 Weinkühlerständer
 Columna porta cubo champany
 H cm. 60
 H 23 3/8"

67301



67304

mm. 1,2 GIOTTO
Portaggiaccio termico con coperchio
Insulated ice-bucket with lid
Seau à glaçons thermique
avec couvercle
Isolier-Eisgefäß
Cubitera hielo con tapa

Ø cm 14 Ø 5 1/2"
H cm 13 H 5"
cl.72 oz. 24 1/3

Ø cm 24 Ø 9 1/2"
H cm 22 H 8 5/8"
lt. 4,0 gal. 1

669



668

mm. 1,2 GIOTTO
Secchiello spumante e ghiaccio
Sparkling wine cooler / Ice bucket
Seau à champagne et à glaçons
Wein- Sektkühler / Eisgefäß
Cubo para champany y para hielo

Ø cm 24 Ø 9 1/2"
H cm 23 H 9"
lt. 5,0 gal. 1 1/3

Ø cm 14,5 Ø 5 2/3"
H cm 13 H 5 1/9"
lt. 1,4 oz. 47 1/3

666E



mm. 1,2 GIOTTO
Colonna portasecchiello spumante
Wine cooler stand
Pied pour seau à champagne
Weinkühlerstand
Columna porta cubo champany

H cm. 67,5 H 26 5/8"

NEW

BAR

159



mm. 1,2 STOCOLMA
 Secchiello per spumante
 Sparkling wine cooler
 Seau à champagne
 Wein- und Sektkühler
 Cubo para champany

Ø cm.22,5
 H cm.23
 lt. 8,5

Ø 8 7/8"
 H 9"
 gal. 2 1/4

158



mm. 1,2 STOCOLMA
 Secchiello per ghiaccio
 Ice bucket
 Seau à glaçons
 Eisgefäß
 Cubitera para hielo

Ø cm.14
 H cm.13
 cl. 150

Ø 5 1/2"
 H 5 1/8"
 oz. 50 3/4

666S



mm. 1,2 STOCOLMA
 Colonna portasecchiello spumante
 Wine cooler stand
 Pied pour seau à champagne
 Weinkühlerständer
 Columna porta cubo champany

H cm. 60 H 23 7/8"



NEW

BAR

NEW

948



mm. 1,2 LESS IS MORE
Rinfrescavino spumante da 3 bottiglie o 2 Magnum
Sparkling wine cooler for 3 bottles or 2 Magnum
Seau à champagne 3 bouteilles ou 2 Magnum
Champagnerkühler für 3 Flaschen oder 2 Magnum
Cubo para refrescar 3 botellas de vino spumante

cm. 35 x 15
H cm. 18
lt. 9
13 3/4" x 5 7/8"
H 7 1/8"
gal. 2 1/2

430



mm. 1,2 FASHION
Rinfrescavino spumante da 2 bottiglie o Magnum
Sparkling wine cooler for 2 bottles or Magnum
Seau à champagne 2 bouteilles ou Magnum
Champagnerkühler für 2 Flaschen oder Magnum
Cubo para refrescar 2 botellas de vino spumante

H cm. 21
cm. 21 x 21
lt. 9
H 8 1/4"
8 1/4" x 8 1/4"
gal. 2 1/2

666M



mm. 1,2 LESS IS MORE
Colonna portasecchiello spumante
Wine cooler stand
Pied pour seau à champagne
Weinkühlerständer
Columna porta cubo champany

H cm. 62
cm. 38 x 25
H 24 2/5"
15" x 9 7/8"

666L

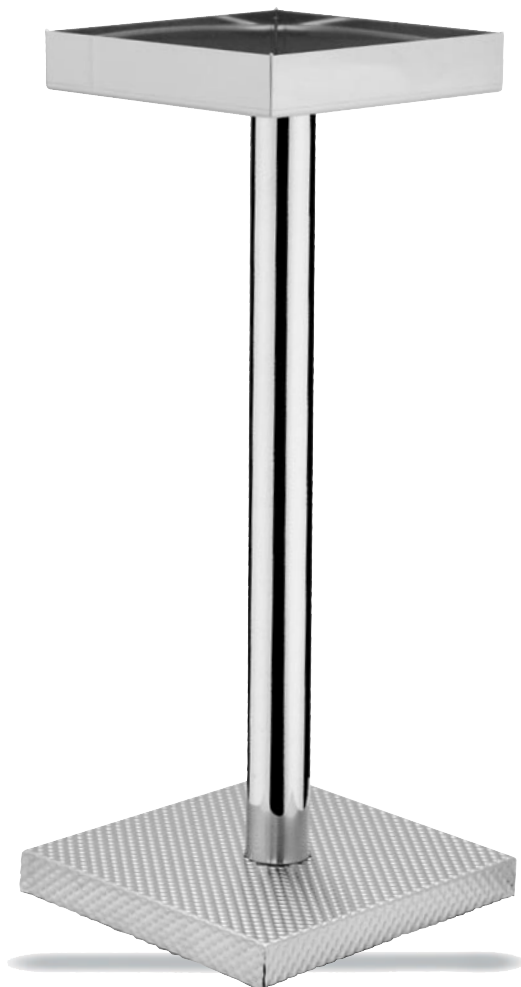

mm. 1,2 FASHION
Colonna portasecchiello spumante
Wine cooler stand
Pied pour seau à champagne
Weinkühlerständer
Columna porta cubo champany

H cm. 61,5
H 24 1/5"



597



mm. 1,2 UNO
 Secchiello per ghiaccio
 Ice bucket
 Seau à glaçons
 Eisgefäß
 Cubitera hielo

Ø cm. 16,8 Ø 6 5/8"
 H cm. 11 H 4 3/8"
 cl. 150 oz. 50 3/4

598



mm. 1,2 UNO
 Secchiello per spumante
 Sparkling wine cooler
 Seau à champagne
 Wein- und Sektkühler
 Cubo para champany

Ø cm. 29 Ø 11 3/8"
 H cm. 18,5 H 7 1/4"
 lt. 8 gal. 2

666W

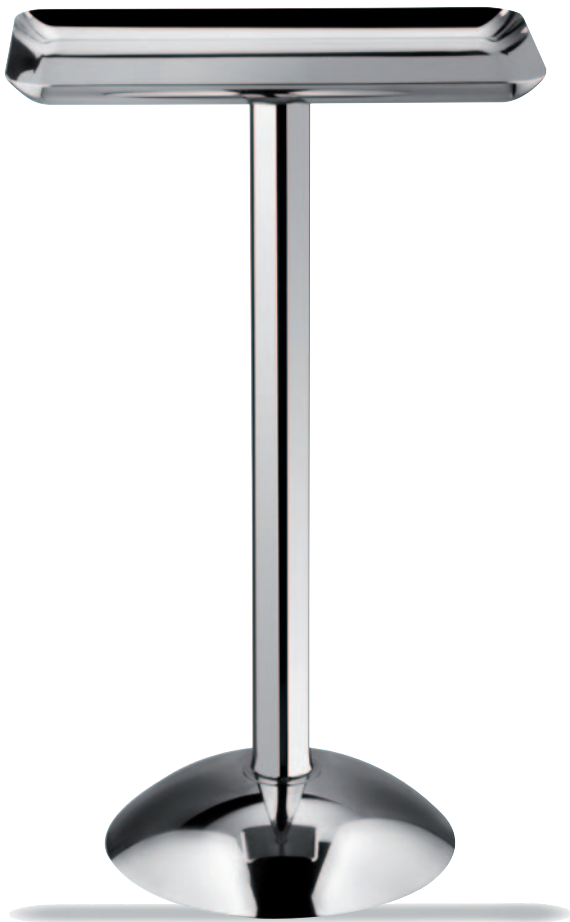

mm. 1,2 Gueridon d'appoggio rettangolare H cm. 62 H 24 2/5"
 Rectangular gueridon cm. 38 x 25 15" x 9 7/8"
 But de canapé rectangulaire
 Gueridon, rechteckig
 Gueridon rectangular

666Z



mm. 1,2 Gueridon d'appoggio ovale H cm. 62 H 24 2/5"
 Oval gueridon cm. 46 x 31 18 1/8" x 12 1/4"
 But de canapé oval
 Gueridon, oval
 Gueridon oval

599



mm. 1,2 UNO
 Secchiello per spumante
 Sparkling wine cooler
 Seau à champagne
 Wein- und Sektkühler
 Cubo para champany

Ø cm. 29 Ø 11 3/8"
 H cm. 18,5 H 7 1/4"
 lt. 8 gal. 2

589



Ciotola tonda
 Round bowl
 Bol ronde
 Früchtekorb rund
 Cuenco redondo

Ø cm. 28 Ø 11"
 H cm. 17,3 H 6 5/8"
 lt. 6,03 qt. 6 1/3

599

58928

7 colori disponibili - pag. 312 - 313
 7 colors available - pages 312 - 313
 7 couleurs disponibles - pag. 312 - 313
 7 verschiedenen Farben verfügbar - Seiten 312 - 313
 7 colores disponibles - pag. 312 - 313

589 - Ø cm. 28
 Ø 11"



666C

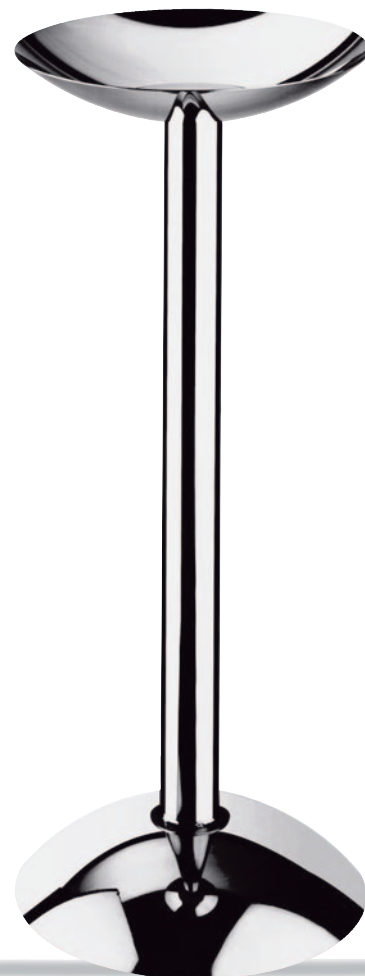

mm. 1,2 UNO
 Colonna portasecchiello spumante
 Wine cooler stand
 Pied pour seau à champagne
 Weinkühlerständer
 Columna porta cubo champany
 H cm. 67,5 H 26 5/8"

598

59870

Logo traforato a richiesta
 Fretworked logo on demand
 Logo ajourée sur demande
 Firmenzeichen gelocht auf Verlangen
 Logo perforado en demanda

589 - Ø cm. 64
 Ø 25 1/4"

589 - Ø cm. 28
 Ø 11"



598
 mm. 1,2 Secchiello Ø cm. 29 Ø 11 3/8"
 Basket H cm. 18,5 H 7 1/4"
 Corbeille lt. 8 gal. 2
 Früchtekorb
 Cesta

59870
 mm. 1,2 Big Champagnera Ø cm. 67,5 Ø 26 3/8"
 Champagne bowl H cm. 43 H 17"
 Bol a champagne lt. 80 gal. 21
 Champagner Bowl
 Cesta para champany

666K



NEW

mm. 1,2 Colonna porta big champagnera H cm. 51 H 20"
Champagne bowl stand
Pied pour bol a champagne
Champagner Bowlständer
Columna porta cesta champany

A



Ambra
Amber
Amber
Amber
Ambar



G



Granato
Garnet
Grenat
Granat
Granate

M



Ametista
Amethyst
Amethyste
Amethyst
Amatista

W



Trasparente
Transparent
Glace
Transparent
Vidrio

Z



Zaffiro
Saphyre
Saphir
Saphir
Zafiro

S



Smeraldo
Emerald
Emeraude
Smaragd
Esmeralda

O



Onice
Onyx
Onyx
Onyx
Onice

909



mm. 1,2 Secchiello per ghiaccio forato
Ice bucket fretworked handles
Seau à glaçons anses ajourée
Eisgefäß mit Griffen
Cubitera hielo asa perforada

cm. 22 x 20 8 3/4" x 7 7/8"
H cm. 11,5 H 4 5/8"
lt. 1,2 oz. 40 1/2

912



mm. 1,2 Secchiello per spumante forato
Sparkling wine cooler fretw. handles
Seau à champagne anses ajourée
Wein- und Sektkühler mit Griffen
Cubo para champany asa perforada

cm. 39 x 36 15 3/8" x 14 1/4"
H cm. 17,5 H 7"
lt. 7 gal. 1 4/5

730



mm. 1,2 Spumantiera 12 bottiglie champagne
Giant champagne bucket for 12 bottles
Seau à champagne géante pour 12 bouteilles
Champagner Bowl für 12 Flaschen
Cubo de champagne gigante para 12 botellas

cm. 75 x 65 29 1/2" x 25 5/8"
H cm. 19 H 7 1/2"
lt. 15 gal. 3 7/8

899



mm. 1,2 Secchiello per ghiaccio
Ice bucket
Seau à glaçons
Eisgefäß
Cubitera hielo

cm. 22 x 20 8 3/4" x 7 7/8"
H cm. 11,5 H 4 5/8"
lt. 1,2 oz. 40 1/2

910



mm. 1,2 Secchiello per spumante
Sparkling wine cooler
Seau à champagne
Wein- und Sektkühler
Cubo para champany

cm. 39 x 36 15 3/8" x 14 1/4"
H cm. 17,5 H 7"
lt. 7 gal. 1 4/5

686



mm. 1,2 Champagnera 5 bott. c/pied. Ø cm. 40 Ø 15 3/4"
 Giant Champagne bucket 5 bot. H cm. 38,5 H 15 1/6"
 Seau à champagne p/5 bott. lt. 15 gal. 4
 Champagner Bowl 5 Fläsche
 Cubo de champagne p/5 bot.

685



mm. 1,2 Champagnera 5 bott. s/pied. Ø cm. 40 Ø 15 3/4"
 Giant Champagne bucket 5 bot. H cm. 21,8 H 8 3/5"
 Seau à champagne p/5 bott. lt. 15 gal. 4
 Champagner Bowl 5 Fläsche
 Cubo de champagne p/5 bot.

666I



mm. 1,2 Colonna portabottiglie spumante H cm. 78 H 30 5/7"
 Wine cooler stand
 Pied pour seau à champagne
 Weinkühlerständer
 Columna porta cubo champany

674



mm. 1,2 Spumantiera termica 5 bott. s/pied. Ø cm. 40 Ø 15 3/4"
 Giant insulated Champagne bucket 5b. H cm. 21,8 H 8 3/5"
 Seau à champagne thermique p/5 bou. lt. 15 gal. 4
 Isolier Champagner Bowl 5 Fläsche
 Cubo térmico para champagne p/5 bot.

698

NEW



mm. 1,2 Raccogli tappi in sughero cm. 12 x 6 4 3/4" x 2 1/5"
 Corks holder cl. 15 oz. 5 1/8
 Porte-bouchons
 Korkenhalter
 Porta corchos

380



382
Lungh. cm. 17,5
Length 6⁷/₈"
mm. 1,5

mm. 1,2 ERGONOMICA
Secchiello e molla per ghiaccio
Ice bucket and ice tongs
Seau à glaçons et pince à glaçons
Eisgefäß und Eiszange
Cubitera hielo y pinzas hielo

cl. 200
oz. 67 ⁵/₈

381



mm. 1,2 ERGONOMICA
Secchiello per spumante
Sparkling wine cooler
Seau à champagne
Wein-und Sektkühler
Cubo para champany

lt. 4,5
gal. 1¹/₄

683



mm. 1,2 Secchio per ghiaccio
Ice bucket with grill
Seau à glaçons
Eisgefäß
Cubitera hielo

Ø cm.14 Ø 5¹/₂"
H.cm.13 H. 5⁵/₈"
cl. 150 oz. 50³/₄

684



mm. 1,2 Secchio per spumante
Sparkling wine cooler
Seau à champagne
Wein-und Sektkühler
Cubo para champany

Ø cm.23 Ø 9"
H cm.22,5 H 8⁷/₈"
lt. 8,5 gal. 2¹/₄

941



mm. 1,2 Portacannucce
Straw holder
Porta pailles
Strohalm Halter
Porta-palillas

Ø cm. 9 Ø 3 ¹/₄"

10001150



mm. 1,2 Golf club mixer spoon
Golf club mixer spoon
Golf crosse pour cocktail
Golf Schleger für Long drink
Golf club cucharita coctél

cm. 16,5 6 ¹/₂"

438



mm. 1,2

OVO
Secchiello per spumante
Sparkling wine cooler
Seau à champagne
Wein- und Sektkühler
Cubo para champany

Ø cm. 19 Ø 7 1/2"
H cm. 22 H 8 5/8"
lt. 4,5 gal. 1 1/4

439



mm. 1,2

OVETTO
Secchiello per ghiaccio
Ice-bucket
Seau à glaçons
Eisgefäß
Cubitera hielo

Ø cm. 11 Ø 4 3/8"
H cm. 13 H 5 1/8"
cl. 100 oz. 33 7/8

689



mm. 1,2

Secchiello per spumante
Sparkling wine cooler
Seau à champagne
Wein- und Sektkühler
Cubo para champany

Ø cm. 19 Ø 7 1/2"
H cm. 20 H 7 3/4"
lt. 2,5 oz. 84 1/2

688



mm. 1,2

Secchiello per ghiaccio
Ice-bucket
Seau à glaçons
Eisgefäß
Cubitera hielo

Ø cm. 11 Ø 4 3/8"
H cm. 12,5 H 4 7/8"
cl. 55 oz. 18 5/8

658



Cubetto luminoso confez. 72 pezzi cm. 2,5 x 2,5 1" x 1"
LED ice cube 72 pcs. box H cm. 2,5 H 1"
Glaçons lumineux 72 pièces
Eiswürfel LED 72 Stücke
Cubito hielo LED 72 piezas

Idoneo al contatto con gli alimenti.

Suitable for contact with food

Materiale certificato:
LFGB - German Food, Commodities and Animal Feed Code of Law
DIN 10955 - 2004
ISO 11885:2007
BfR Recommendations on Food Contact Materials - part V & VI 2010 & 2010
Regolamento CEE (EU) 10/2011
Regolamento CEE (EC) 1907/2006
Regolamento CEE (EC) 1935/2004

Certified material:
LFGB - German Food, Commodities and Animal Feed Code of Law
DIN 10955 - 2004
ISO 11885:2007
BfR Recommendations on Food Contact Materials - part V & VI 2010 & 2010
Regulation CEE (EU) 10/2011
Regulation CEE (EC) 1907/2006
Regulation CEE (EC) 1935/2004

Durata delle batterie: 12 ore

Battery life: 12 hours

Front Cooking



FRONT COOKING

- Design e performance tecniche combinati alla perfezione
 - Adatte a tutte le fonti di calore e cottura
 - Manici ergonomici
 - Progettate in collaborazione con i più importanti produttori di cucine professionali per far rendere al meglio fuochi ed induzione
-
- Perfect combination of technical performance and design.
 - Suitable for all hobs.
 - Ergonomic handles.
 - Projected in cooperation with the most important manufacturers of professional kitchens, in order to perform hobs and induction at their best.
-
- Design et performance techniques combinées à la perfection
 - Aptes à toutes les font de chaleur et de cuisson
 - Poignées ergonomiques
 - Conçues en collaboration avec les principaux producteurs de cuisines professionnelles afin de rendre les feux et l'induction plus performants.
-
- Perfekte Kombination aus technische Leistung und Design.
 - Für alle Kochfelder geeignet.
 - Ergonomische Griffe.
 - Projektiert in Zusammenarbeit mit den wichtigsten Hersteller von Profiküchen, um Kochfelder und Induktion optimal zur Geltung zu bringen.
-
- Perfecta combinación de prestaciones técnicas y Design.
 - Apto para todas las placas.
 - Asas ergonómicas.
 - Proyectado en cooperación con los más importantes fabricantes de cocinas profesionales, con el fin de realizar las mejores cocinas e inducción.

MEPRA
S.p.A.

Apartments

APARTMENTS

- Design differenti per ogni tipo di stile
- Alte performance su tutti i piani di cottura
- Manici ergonomici ad alta resistenza al calore
- Vasto assortimento di misure
- Different Design for any kind of style.
- High performance on every hobs.
- Heat resistant ergonomic handles.
- Wide assortment of sizes.
- Différents designs pour chaque style
- Hautes performances sur tous les fonts de cuisson
- Poignées ergonomiques à haute résistance à la chaleur
- Large assortiment de tailles.
- Unterschiedliches Design für jeden Stil.
- Höchste Leistung auf allen Kochfeldern.
- Hitzebeständig ergonomisch Griffe.
- Breites Sortiment an Größen.
- Design diferente para cualquier tipo de estilo.
- Alto rendimiento en todas las placas.
- Mangos ergonómicos, resistentes al calor.
- Amplia variedad de tallas.



MEPRA
S.p.A.





Acciaio Inossidabile 18/10, cuore in alluminio, esterno in acciaio per induzione
 Superficie esterna ed interna lucidate a specchio
 Maniglie con rivetti in acciaio inossidabile 18/10, a tenuta rinforzata
 Il calore si distribuisce uniformemente su tutta la superficie della pentola
 Maggiore controllo della temperatura di cottura
 Notevole risparmio di energia e tempo
 Minor alterazione delle vitamine e proteine durante la cottura

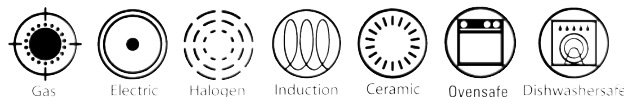

18/10 Stainless Steel, aluminum core, Induction Steel outside
 Mirror polished surfaces, outside and inside
 Handles with strongly fixed 18/10 Stainless Steel rivets,
 The heat is distributed evenly over the surface of the pot
 Greater control of cooking temperature
 Considerable saving of energy and time
 Minor alteration of vitamins and proteins during cooking



Strato interno - Inner layer

Acciaio Inossidabile 18/10 - Il materiale in assoluto più igienico e più facile da pulire
 Stainless Steel 18/10 - The material even more hygienic easier to clean

Strato centrale - Middle layer

Cuore in alluminio - Il materiale leggero, non soggetto a corrosione ed atossico
 Aluminum core - The lightweight, non-corrosive and non-toxic

Strato esterno - Outer layer

Acciaio speciale per induzione
 Special steel for induction



1831

Risottiera e tegame per arrosti e brasati in **Trimetallo** con interno in acciaio inossidabile 18/10 senza rivestimento
Tri-ply Low casserole for risotto and stews.

Ø cm. 24 - Lt. 3,0
 Ø cm. 28 - Lt. 4,0

Ø 9 1/2" - Qt. 3 1/6
 Ø 11" - Qt. 4 1/5



1821

Sauteuse per condimenti e salse in **Trimetallo** con interno in acciaio inossidabile 18/10 senza rivestimento
Tri-ply Casserole for serving sauces, soups and side dishes.

Ø cm. 18 - Lt. 2,0
 Ø cm. 20 - Lt. 3,0
 Ø cm. 22 - Lt. 3,5
 Ø cm. 24 - Lt. 5,0

Ø 7" - Qt. 2 1/9
 Ø 7 1/8" - Qt. 3 1/6
 Ø 8 2/3" - Qt. 3 2/3
 Ø 9 1/2" - Qt. 5 1/3



1801

Pentola in **Trimetallo** con interno in acciaio inossidabile 18/10 senza rivestimento
Tri-ply Deep pot

Ø cm. 20 - Lt. 3,5
 Ø cm. 22 - Lt. 5,0
 Ø cm. 24 - Lt. 6,5

Ø 7 7/8" - Qt. 3 2/3
 Ø 8 2/3" - Qt. 5 1/3
 Ø 9 1/2" - Qt. 6 1/8



1811

Mini casserole per soufflé, condimenti e salse in **Trimetallo** con interno in acciaio inossidabile 18/10 senza rivestimento
Tri-ply Mini casseroles for soufflé, condiments and sauces

Ø cm. 9 - Lt. 0,25
 Ø 3 1/2" - Qt. 1/11
 Ø cm. 14 - Lt. 1,0
 Ø 5 1/2" - Qt. 1
 Ø cm. 16 - Lt. 2,0
 Ø 6 1/3" - Qt. 2 1/9



1821

Mini casserole per soufflé, condimenti e salse in **Trimetallo** con interno in acciaio inossidabile 18/10 senza rivestimento
Tri-ply Mini casseroles for soufflé, condiments and sauces

Ø cm. 12 - Lt. 0,6
 Ø 4 2/3" - Qt. 1/11



1841
Padella in **Trimetallo**
Tri-ply Frying pan
Poêle à frire
Bratpfanne
Sartén

Ø cm. 22	Ø 8 ² / ₃ "
Ø cm. 26	Ø 10 ¹ / ₄ "
Ø cm. 30	Ø 11 ³ / ₄ "

Acciaio Inossidabile 18/10, cuore in alluminio, esterno in acciaio per induzione
 Superficie esterna ed interna lucidate a specchio
 Maniglie con rivetti in acciaio inossidabile 18/10, a tenuta rinforzata
 Il calore si distribuisce uniformemente su tutta la superficie della pentola
 Maggiore controllo della temperatura di cottura
 Notevole risparmio di energia e tempo
 Minor alterazione delle vitamine e proteine durante la cottura

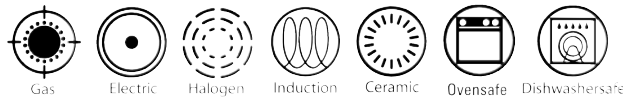

18/10 Stainless Steel, aluminum core, Induction Steel outside
 Mirror polished surfaces, outside and inside
 Handles with strongly fixed 18/10 Stainless Steel rivets,
 The heat is distributed evenly over the surface of the pot
 Greater control of cooking temperature
 Considerable saving of energy and time
 Minor alteration of vitamins and proteins during cooking

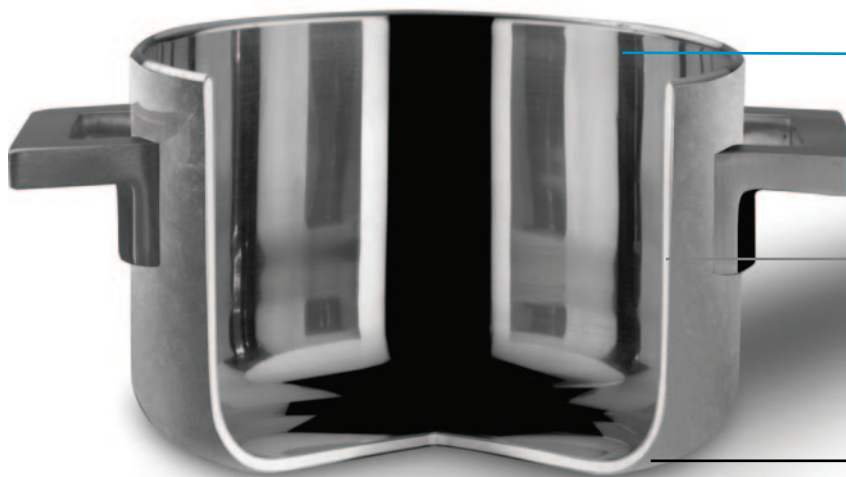

Strato interno - Inner layer

Acciaio Inossidabile 18/10 - Il materiale in assoluto più igienico e più facile da pulire
 Stainless Steel 18/10 - The material even more hygienic easier to clean

Strato centrale - Middle layer

Cuore in alluminio - Il materiale leggero, non soggetto a corrosione ed atossico
 Aluminum core - The lightweight, non-corrosive and non-toxic

Strato esterno - Outer layer

Acciaio speciale per induzione
 Special steel for induction



2831
 Risottiera e tegame per arrosti e brasati in **Trimetallo** con interno in acciaio inossidabile 18/10 senza rivestimento
Tri-ply Low casserole for risotto and stews.

Ø cm. 24 - Lt. 3,0 Ø 9 1/2" - Qt. 3 1/6
 Ø cm. 28 - Lt. 4,0 Ø 11" - Qt. 4 1/5



2821
 Sauteuse per condimenti e salse in **Trimetallo** con interno in acciaio inossidabile 18/10 senza rivestimento
Tri-ply Casserole for serving sauces, soups and side dishes.

Ø cm. 18 - Lt. 2,0 Ø 7" - Qt. 2 1/9
 Ø cm. 20 - Lt. 3,0 Ø 7 7/8" - Qt. 3 1/6
 Ø cm. 22 - Lt. 3,5 Ø 8 2/3" - Qt. 3 2/3
 Ø cm. 24 - Lt. 5,0 Ø 9 1/2" - Qt. 5 1/3



2801
 Pentola in **Trimetallo** con interno in acciaio inossidabile 18/10 senza rivestimento
Tri-ply Deep pot

Ø cm. 20 - Lt. 3,5 Ø 7 7/8" - Qt. 3 2/3
 Ø cm. 22 - Lt. 5,0 Ø 8 2/3" - Qt. 5 1/3
 Ø cm. 24 - Lt. 6,5 Ø 9 1/2" - Qt. 6 1/8



2811
 Mini casseruole per soufflé, condimenti e salse in **Trimetallo** con interno in acciaio inossidabile 18/10 senza rivestimento
Tri-ply Mini casseroles for soufflé, condiments and sauces

Ø cm. 9 - Lt. 0,25 Ø 3 1/2" - Qt. 1/11
 Ø cm. 14 - Lt. 1,0 Ø 5 1/2" - Qt. 1
 Ø cm. 16 - Lt. 2,0 Ø 6 1/3" - Qt. 2 1/9



2821
 Ø cm. 12 - Lt. 0,6
 Ø 4 2/3" - Qt. 1/11



2841
Padella in **Trimetallo**
Tri-ply Frying pan
Poêle à frire
Bratpfanne
Sartén

Ø cm. 22	Ø 8 ² / ₃ "
Ø cm. 26	Ø 10 ¹ / ₄ "
Ø cm. 30	Ø 11 ³ / ₄ "

Acciaio Inossidabile 18/10, cuore in alluminio, esterno in acciaio per induzione
 Superficie esterna ed interna lucidate a specchio
 Maniglie con rivetti in acciaio inossidabile 18/10, a tenuta rinforzata
 Il calore si distribuisce uniformemente su tutta la superficie della pentola
 Maggiore controllo della temperatura di cottura
 Notevole risparmio di energia e tempo
 Minor alterazione delle vitamine e proteine durante la cottura

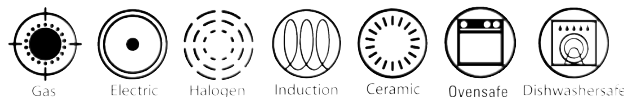

18/10 Stainless Steel, aluminum core, Induction Steel outside
 Mirror polished surfaces, outside and inside
 Handles with strongly fixed 18/10 Stainless Steel rivets,
 The heat is distributed evenly over the surface of the pot
 Greater control of cooking temperature
 Considerable saving of energy and time
 Minor alteration of vitamins and proteins during cooking



Strato interno - Inner layer

Acciaio Inossidabile 18/10 - Il materiale in assoluto più igienico e più facile da pulire
 Stainless Steel 18/10 - The material even more hygienic easier to clean

Strato centrale - Middle layer

Cuore in alluminio - Il materiale leggero, non soggetto a corrosione ed atossico
 Aluminum core - The lightweight, non-corrosive and non-toxic

Strato esterno - Outer layer

Acciaio speciale per induzione
 Special steel for induction



18310

Risottiera e tegame per arrosti e brasati in **Trimetallo** con interno in acciaio inossidabile 18/10 senza rivestimento
Tri-ply Low casserole for risotto and stews.

Ø cm. 24 - Lt. 3,0
 Ø cm. 28 - Lt. 4,0

Ø 9 1/2" - Qt. 3 1/6
 Ø 11" - Qt. 4 1/5



18210

Sauteuse per condimenti e salse in **Trimetallo** con interno in acciaio inossidabile 18/10 senza rivestimento
Tri-ply Casserole for serving sauces, soups and side dishes.

Ø cm. 18 - Lt. 2,0
 Ø cm. 20 - Lt. 3,0
 Ø cm. 22 - Lt. 3,5
 Ø cm. 24 - Lt. 5,0

Ø 7" - Qt. 2 1/9
 Ø 7 1/8" - Qt. 3 1/6
 Ø 8 2/3" - Qt. 3 2/3
 Ø 9 1/2" - Qt. 5 1/3



18010

Pentola in **Trimetallo** con interno in acciaio inossidabile 18/10 senza rivestimento
Tri-ply Deep pot

Ø cm. 20 - Lt. 3,5
 Ø cm. 22 - Lt. 5,0
 Ø cm. 24 - Lt. 6,5

Ø 7 7/8" - Qt. 3 2/3
 Ø 8 2/3" - Qt. 5 1/3
 Ø 9 1/2" - Qt. 6 1/3



18110

Mini casseruole per soufflé, condimenti e salse in **Trimetallo** con interno in acciaio inossidabile 18/10 senza rivestimento
Tri-ply Mini casseroles for soufflé, condiments and sauces

Ø cm. 9 - Lt. 0,25
 Ø 3 1/2" - Qt. 1/11
 Ø cm. 14 - Lt. 1,0
 Ø 5 1/2" - Qt. 1
 Ø cm. 16 - Lt. 2,0
 Ø 6 1/3" - Qt. 2 1/9



18210

Mini casseruole per soufflé, condimenti e salse in **Trimetallo** con interno in acciaio inossidabile 18/10 senza rivestimento
Tri-ply Mini casseroles for soufflé, condiments and sauces

Ø cm. 12 - Lt. 0,6
 Ø 4 2/3" - Qt. 1/11



18410
Padella in **Trimetallo**
Tri-ply Frying pan
Poêle à frire
Bratpfanne
Sartén

Ø cm. 22	Ø 8 ² / ₃ "
Ø cm. 26	Ø 10 ¹ / ₄ "
Ø cm. 30	Ø 11 ³ / ₄ "





Rame, cuore in alluminio, interno in acciaio inossidabile 18/10 - Superficie esterna ed interna lucidate a specchio - Maniglie con rivetti in acciaio inossidabile 18/10, a tenuta rinforzata

Il calore si distribuisce uniformemente su tutta la superficie della pentola - Maggiore controllo della temperatura di cottura - Notevole risparmio di energia e tempo - Minor alterazione delle vitamine e proteine durante la cottura

Copper, aluminum core, 18/10 Stainless Steel inside - Mirror polished surfaces, outside and inside - Handles with strongly fixed 18/10 Stainless Steel rivets.

The heat is distributed evenly over the surface of the pot - Greater control of cooking temperature - Considerable saving of energy and time - Minor alteration of vitamins and proteins during cooking.

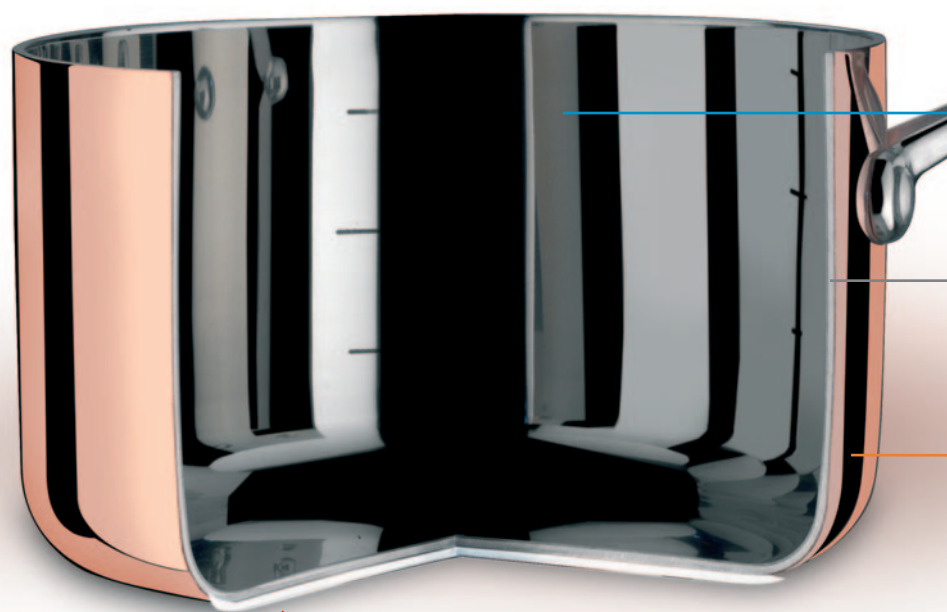
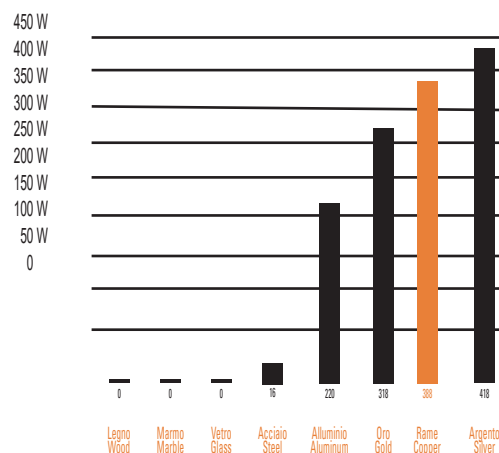

Strato interno - Inner layer

Acciaio Inossidabile 18/10 - Il materiale in assoluto più igienico e più facile da pulire
Stainless Steel 18/10 - The material even more hygienic easier to clean

Strato centrale - Middle layer

Cuore in alluminio - Il materiale leggero, non soggetto a corrosione ed atossico
Aluminum core - The lightweight, non-corrosive and non-toxic

Strato esterno - Outer layer

Rame - Il materiale a più alta conduttività dopo l'argento
Copper - The material with higher conductivity after silver

Fondo speciale - Special bottom
Adatto all'induzione - Suitable for inductions stoves too.

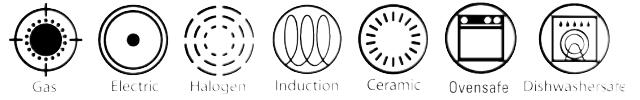

1231

Risottiera e tegame per arrosti e brasati in **Trimetallo** con interno in acciaio inossidabile 18/10 senza rivestimento.
Low casserole for risotto and stews. **Tri-ply** with 18/10 inside, aluminum and copper.
Ø cm. 28 - Lt. 4,5 Ø 11" - Qt. 4 1/2



1211

Sauteuse per condimenti e salse in **Trimetallo** con interno in acciaio inossidabile 18/10 senza rivestimento.
Tri-ply saucepan with 18/10 inside, aluminum and copper.
Ø cm. 16 - Lt. 1,9 Ø 6 1/3" - Qt. 1



1241

Padella in **Trimetallo** con interno in acciaio inossidabile 18/10 senza rivestimento
Tri-ply frying pan with 18/10 inside, aluminum and copper.
Ø cm. 26 - Lt. 2,9 Ø 10 1/4" - Qt. 2 1/8



1201

Pentola in **Trimetallo** con interno in acciaio inossidabile 18/10 senza rivestimento
Tri-ply deep pot with 18/10 inside, aluminum and copper.
Ø cm. 20 - Lt. 4,0 Ø 7 7/8" - Qt. 4 1/5
Ø cm. 24 - Lt. 7,7 Ø 9 1/2" - Qt. 8 1/8



1221

Casseruola per soufflé, condimenti e salse in **Trimetallo** con interno in acciaio inossidabile 18/10 senza rivestimento
Tri-ply Saucepan for soufflé, seasonings and sauces with 18/10 inside, aluminum and copper.
Ø cm. 20 - Lt. 2,9 Ø 7 7/8" - Qt. 3
Ø cm. 24 - Lt. 3,5 Ø 9 1/2" - Qt. 3 2/3



2179
Padella antiaderente
Non-stick frying pan
Poêle à frire anti-adhérent
Antihaft Bratpfanne
Sartén antiadherente

Ø cm. 20	Ø 7 ¹ / ₈ "
Ø cm. 24	Ø 9 ¹ / ₂ "
Ø cm. 28	Ø 11"
Ø cm. 32	Ø 12 ¹ / ₅ "



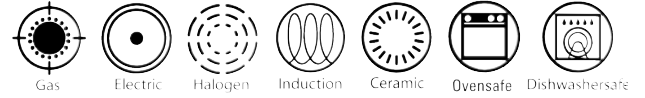

Strato interno - Inner layer

Rivestimento triplo strato antiaderente di ultima generazione, antimacchia. Rivestimento resistente agli utensili metallici non taglienti.

The last generation triple non-stick layer is so strong, that allow you to cook with non-sharp metal utensils.

Strato esterno - Outer layer

Triplo fondo incapsulato per cottura ad induzione

Sandwiched thermoradiant bottom for induction cooking

Acciaio Inossidabile 18/10 - Fondo termodiffusore incapsulato (Acciaio Inossidabile 18/10 - Alluminio - Acciaio per induzione). Bordo antigoccia rinforzato - Lavabile in lavastoviglie senza che ne venga compromessa l'antiaderenza. Le eccezionali proprietà antiaderenti permettono una cucina completamente priva di grassi, per uno stile di vita attivo e salutare. Rispetto della natura e del pianeta, grazie alla totale assenza di PFOA.

18/10 Stainless Steel - Sandwiched thermoradiant bottom (18/10 Stainless Steel - Aluminum - Steel for Induction). Reinforced non-drip edge. The non-stick coating is not compromised during the washing cycle. The outstanding non-stick properties also allow a fully fatfree cuisine, for an active and healthy life. Thanks to the total absence of PFOA, the collection respects the nature.



2180
Bistecchiera ad alto spessore per alte temperature con rivestimento antiaderente, PFOA Free, per induzione, antimacchia, antigraffio.

High gauge steak pan for high heat with "Eterna" non-stick coating, PFOA free, stain resistant and scratch resistant.
cm. 28 x 28 11" x 11"



2131
Risottiera e tegame per arrostiti e brasati con coperchio per alte temperature con rivestimento antiaderente, PFOA Free, per induzione, antimacchia, antigraffio.

Low casserole for risotto and stews with "Eterna" non-stick coating, PFOA free, stain resistant and scratch resistant.
Ø cm. 32 - Lt. 5,0 Ø 12 3/5" - Qt. 5 1/7



2178
Wok saltapasta con coperchio per alte temperature con rivestimento antiaderente, PFOA Free, per induzione, antimacchia, antigraffio.

Wok with lid for high heat with "Eterna" non-stick coating, PFOA Free, for induction, stain resistant and scratch resistant.
Ø cm. 28 - Lt. 3,0 Ø 11 1/4" - Qt. 3 1/2

GOURMET



Gas



Electric



Halogen



Induction



Ceramic



Ovensafe



Dishwashersafe



1501
Pentola alta con coperchio
Deep pot with lid

Ø cm. 20 - Lt. 4,2 Ø 7 7/8" - Qt. 4 2/7
Ø cm. 22 - Lt. 4,8 Ø 8 2/3" - Qt. 5
Ø cm. 24 - Lt. 5,4 Ø 9 1/2" - Qt. 5 2/3



1511
Casseruola 1 manico con coperchio
Deep casserole 1 handle with lid

Ø cm. 16 - Lt. 1,5 Ø 6 1/3" - Qt. 1 2/5



1521
Casseruola fonda 2 manici con coperchio
Deep casserole 2 handles with lid

Ø cm. 20 - Lt. 2,9 Ø 7 7/8" - Qt. 3
Ø cm. 22 - Lt. 3,3 Ø 8 2/3" - Qt. 3 1/2
Ø cm. 24 - Lt. 3,8 Ø 9 1/2" - Qt. 4



1531
Tegame 2 manici con coperchio
Frying pan 2 handles with lid

Ø cm. 26 - Lt. 3,3 Ø 10 1/4" - Qt. 3 1/2
Ø cm. 30 - Lt. 5,6 Ø 11 4/5" - Qt. 5 7/8



1500/08

Batteria da cucina 8 pezzi
8 pcs. Kitchen set
Composta da - Composed by:

1 Pentola alta - Deep pot	Ø cm. 20	Ø 7 7/8"
1 Casseruola 1 manico	Ø cm. 16	Ø 6 1/3"
1 Deep casserole 1 handle		
1 Casseruola 2 manici	Ø cm. 20	Ø 7 7/8"
1 Deep casserole 2 handles		
1 Tegame 2 manici	Ø cm. 26	Ø 10 1/4"
1 Frying pan 2 handles		
2 Coperchi - Lids	Ø cm. 20	Ø 7 7/8"
1 Coperchio - Lid	Ø cm. 16	Ø 6 1/3"
1 Coperchio - Lid	Ø cm. 26	Ø 10 1/4"



1500/14

Batteria da cucina 14 pezzi
14 pcs. Kitchen set
Composta da - Composed by:

1 Pentola alta - Deep pot	Ø cm. 20	Ø 7 7/8"
1 Casseruola 1 manico	Ø cm. 16	Ø 6 1/3"
1 Deep casserole 1 handle		
1 Casseruola 2 manici	Ø cm. 20	Ø 7 7/8"
1 Deep casserole 2 handles		
1 Tegame 2 manici	Ø cm. 26	Ø 10 1/4"
1 Frying pan 2 handles		
1 Spghettiera	Ø cm. 22	Ø 8 2/3"
1 Pasta pot (3pcs)		
1 Cuociverdura	Ø cm. 22	Ø 8 2/3"
1 Vegetable steamer (3pcs)		
1 Coperchio - Lid	Ø cm. 16	Ø 6 1/3"
2 Coperchi - Lids	Ø cm. 20	Ø 7 7/8"
1 Coperchio - Lid	Ø cm. 26	Ø 10 1/4"





1579
Padella antiaderente
Non-stick frying pan
Poêle à frire anti-adhérent
Antihaft Bratpfanne
Sartén antiadherente
Ø cm. 22 Ø 8 ¹/₃"
Ø cm. 26 Ø 10 ¹/₄"
Ø cm. 30 Ø 11 ¹/₅"

GOURMET

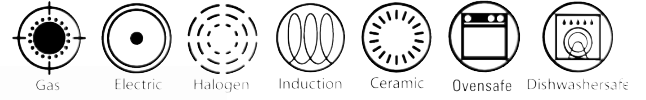

1578
Wok antiaderente con coperchio
Non-stick wok with lid

Ø cm. 30 - Lt. 5,0 Ø 11 3/4" - Qt. 5 1/4



1581
Bollilatte
Milk boiler

cm. 12 - Lt. 1,2

Ø 4 3/4" - Qt. 1 1/2



1591
Inserto cuocipasta 2 scomparti
Pasta pot insert 2 compt.

Per pentola Ø cm. 24
For pot Ø 9 1/2"



883
Colapasta
Colander

cm. 33 13"



1571
Cuocipasta con coperchio
Pasta pot with lid

Ø cm. 22 - Lt. 6,6

Ø 8 2/3" - Qt. 7



1572
Cuociverdura con coperchio
Vegetable steamer with lid

Ø cm. 22 - Lt. 4,3

Ø 8 2/3" - Qt. 4 1/2

Spa & Wellness



- Infrangibile
- Adatto alla lavastoviglie
- Adatto al forno a microonde
- Ideale per:
 - Discoteche
 - Yacht e navi da crociera
 - Cliniche
 - Case di riposo per anziani
 - Asili
- Ideale per tutti i luoghi dove i clienti possono accedere a piedi nudi:
 - Piscine
 - Spiagge
 - Prati
 - Centri di benessere
 - Impianti sportivi
 - Tonalità diverse disponibili a richiesta
- Possono essere personalizzati con logo, anche a più colori

- Unbreakable
- Dishwasher Safe
- Microwave Safe
- Ideal for:
 - Night Clubs
 - Yachts and Cruise Ships
 - Hospitals and Medical Clinics
 - Rest Homes
 - Schools
 - Perfect for Barefoot Environments:
 - Swimming Pools
 - Beaches
 - Lawns
 - Wellness Centers
 - Fitness Centers
 - Available in additional colors.
- Imprinting and logos available. Multicolor printing available.

- Incassable
- Utilisable au laves-vaisselles
- Utilisable au Four à micro-ondes
- Idéal pour :
 - Discothèques
 - Yacht et bateaux de croisière
 - Cliniques
 - Maisons de repos
 - Crèches
- Idéal pour tous les lieux où les clients peuvent accéder à pied nus :
 - Piscines
 - Plages
 - Jardin
 - Centre de bien-être

- Installations sportives
- Tonalités différentes disponibles sur demande
Ils peuvent être personnalisés avec logo, multicouleurs, gravées ou lazer

- Unzerbrechlich
- Spülmaschinenfest
- Microwellenfest
- Daher bestens geeignet zum Gebrauch:
- in Cocktailbars & Night Clubs
- für Yachten und Kreuzfahrtschiffe
- in Kliniken und Heimen
- in Badezimmern
- für Schulen und Kindergärten

Auch aufgrund der Bruchsicherheit perfekt einzusetzen an Orten, die barfuß betreten werden:

- Schwimmbäder und Poolbereiche
- Strände und Strandbars
- Rasenflächen
- Wellnesscenter
- Fitnesscenter
- Alle Produkte sind auch in zusätzlichen, weiteren Farben erhältlich.
- Alle Produkte können auch mit Logos und Beschriftung individualisiert werden.
- Dabei ist auch mehrfarbiger Druck möglich.

- Irrompible
- Apto para lavavajillas
- Apto para microondas
- Ideal para:
- Discotecas
- Yates y barcos de crucero
- Clinicas
- Residencias de ancianos
- Asilos
Ideal para todos los lugares donde los clientes pueden ir descalzos:
- Piscinas
- Playas
- Praderas
- Centros de bienestar
- Centros deportivos
- Tonos diversos disponibles por encargo
- Se pueden personalizar con logo, incluso en varios colores.



588



Bicchiere
Glass
Gobelet
Glas
Vaso

H cm 10
cl. 33
H 3 7/8"
oz. 11 1/8

591



Bicchiere
Glass
Gobelet
Glas
Vaso

H cm 13
cl. 45
H 5"
oz 15 1/4

554



Fondo
Bowl
Bol
Obstschale oval
Cuenco

Ø cm. 18 Ø 7"

553

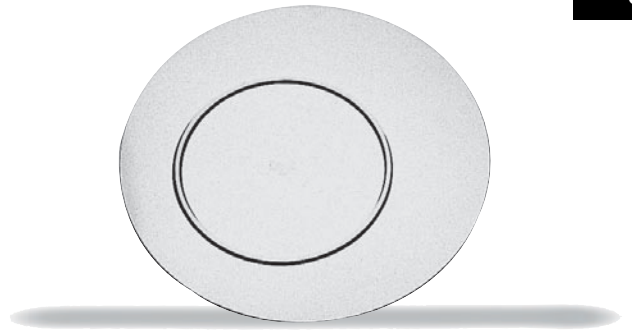

Piano
Tray
Plateau
Tablett oval
Bandeja

Ø cm. 27 Ø 10 1/2"

555



Piano per buffet
Tray for buffet
Plateau pour buffet
Buffettablett
Bandeja para buffet

Ø cm. 27 Ø 10 1/2"

536



Coppa per gelato
Ice cream cup
Coupe à glace
Eisbecher
Copa helado

H cm 12 H 4 3/4"
cl. 27 oz 9 1/8

535



Coppa Martini
Martini glass
Coupe à Martini
Martini glas
Vaso para Martini

H cm. 19 H 7 1/2"
cl 27 oz 9 1/8

534



Bicchiere per birra
Beer glass
Gobelet pour birre
Bierbecher
Vaso para cerveza

H cm. 17,5 H 6 7/8"
cl 45 oz 15 1/8

533



Bicchiere per vino
Beverage glass
Gobelet pour vin
Weinbecher
Vaso para vino

H cm. 24,5 H 9 1/3"
cl 45 oz 15 1/8

527



Bicchiere da whisky cl. 15
Whisky glass
Gobelet pour whisky oz. 5 1/8
Whisky Becher
Vaso para whisky

Bicchiere da liquore cl. 9
Liquor glass
Gobelet pour alcool oz. 3
Schnapsbecher
Vaso para alcohol

543



Bicchiere per champagne
Champagne glass
Gobelet pour champagne
Champagnerglas
Vaso para champany

H cm. 22,7 H 9"
cl. 15 oz. 5 1/8

589



Ciotola tonda
Round bowl
Bol ronde
Früchtekorb, rund
Cuenco redondo

Ø cm. 12 Ø 4 3/4"
H cm. 7,4 H 2 7/8"
cl. 40 oz. 13 1/2

605



Set impilabile di 3 coppette tonde
Stackable set of 3 round bowls
Set empilable de 3 bols ronde
Stapelbarer Relish-Pickles-Gestell, rund
Set impilable de 3 cuencos redondos

cl. 40 (x 3) oz. 13 1/2 (x 3)

589



Ciotola tonda
Round bowl
Bol ronde
Früchtekorb rund
Cuenco redondo

Ø cm. 22 Ø 8 1/2"
H cm. 14 H 5 1/2"
cl. 220 oz. 74 3/8

589+599



589



Ciotola tonda
Round bowl
Bol ronde
Früchtekorb rund
Cuenco redondo

Ø cm. 28 Ø 11"
H cm. 17,3 H 6 5/8"
lt. 6,03 oz. 202 1/2

550



Mug

H cm 10
cl. 33 H 3 7/8"
oz. 11 1/8

552



Piattino per mug e bicchieri (Art. 550,588,591) Ø cm. 13,2 Ø 5 1/4"
Mug coaster (Art. 550,588,591)
Dessous de verre (Art. 550,588,591)
Gläseruntersatz (Art. 550,588,591)
Posavasos por mug (Art. 550,588,591)

592



Tazzina da caffè con piattino
Express coffee cup and saucer
Tasse de moka avec soucoupe
Mokka Tasse mit Untertasse
Taza de moka con platillo

cl 9 oz. 3

593



Tazza da tè con piattino
Tea cup and saucer
Tasse de thé avec soucoupe
Tee Tasse mit Untertasse
Taza de tè con platillo

cl 15 oz 5 1/8

590



Ciotola quadra
Square bowl
Bol carrè
Obstschale viereckig
Cuenco cuadrado

cm. 10 x 10 3 7/8" x 3 7/8"
cl. 27 oz. 9 1/8

606



Set impilabile di 3 coppette quadre
Stackable set of 3 square bowls
Set empilable de 3 bols carrè
Stapelbarer Relish-Pickles-Gestell,
quadratisch
Set impilable de 3 cuencos cuadrados

cl. 27 (x 3) oz. 9 1/8 (x 3)



A Ambra
Amber
Ambre
Amber
Ambar



G Granato
Garnet
Grenat
Granat
Granate



Q Quarzo
Quartz
Quartz
Quarz
Cuarzo



S Smeraldo
Emerald
Émeraude
Smaragd
Esmeralda



V Olivina
Olivine
Olivine
Olivia
Olivino



Z Zaffiro
Sapphyre
Saphir
Saphir
Zafiro

Tutti gli articoli da pagina 342 a pagina 345 sono disponibili in 8 colori, tranne il nero. Gli articoli 533, 534, 535, 536 e 543 sono disponibili solo in 3 colori: bianco, nero e trasparente.

All the items from page 342 to page 345 are available in 8 colors, black excluded. The items 533, 534, 535, 536 and 543 are available in 3 colors only: white, black and transparent.

Tous les articles de la page 342 à la page 345 sont disponibles en 8 couleurs, noir exclu. Les articles 533, 534, 535, 536 et 543 sont uniquement disponibles en 3 couleurs: porcelain, noir et transparent.



M Ametista
Amethyst
Amethyst
Amethyst
Amatista

Alle Polikarbonat-Produkte von Seite 342 bis Seite 345 sind in 8 Farben erhältlich, außer Schwarz. Die Artikel 533, 534, 535, 536 und 543 sind nur in 3 Farben erhältlich: Weiß, Schwarz und Transparent.

Todos los artículos desde la página 342 hasta la página 345 están disponibles en 8 colores, excepto el negro. Los artículos 533, 534, 535, 536 y 543 solo están disponibles en 3 colores: porcelana, negro y transparente.



W Trasparente
Transparent
Glace
Transparent
Vidrio



B Berillo
Beryl
Beryl
Beryl
Berilo



O Onice
Onyx
Onyx
Onyx
Onice



P Porcellana
White
Porcelain
Weiss
Porcelana



N Nero
Black
Noir
Schwarz
Negro



R Rosso
Red
Rouge
Rot
Rojo



886



Secchiello per ghiaccio
Ice bucket
Seau à glaçons
Eisgefäß
Cubitera hielo

Ø cm. 15 Ø 5 7/8"
H cm. 15 H 5 7/8"
cl. 150 oz. 50 3/4

888



Secchiello per spumante
Sparkling wine cooler
Seau à vin/glace
Wein- und Sektkühler
Cubo para champany

Ø cm. 22 Ø 8 7/8"
H cm. 22 H 8 7/8"
lt. 5 gal. 1 1/4

891



Bicchiere
Glass
Gobelet
Glas
Vaso

H cm. 13 H 5"
cl. 33 11 1/8 oz

892



Bicchiere
Glass
Gobelet
Glas
Vaso

H cm. 10 H 4"
cl. 25 8 7/8 oz

517

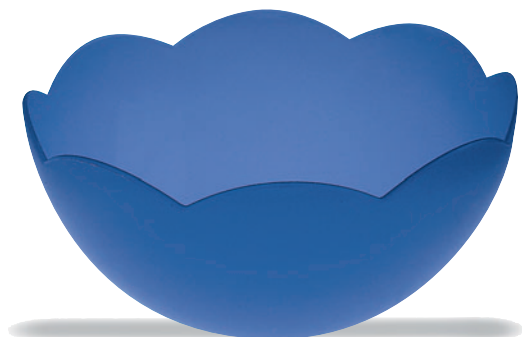

Ciotola
Bowl
Bol
Obstschale
Cuenco

Ø cm. 10 Ø 3 7/8"
cl. 30 oz. 10 1/8
Ø cm. 15 Ø 5 7/8"
cl. 60 oz. 20 1/4
Ø cm. 22 Ø 8 7/8"
cl. 200 oz. 67 7/8
Ø cm. 28 Ø 11"
lt 4 gal. 1

099

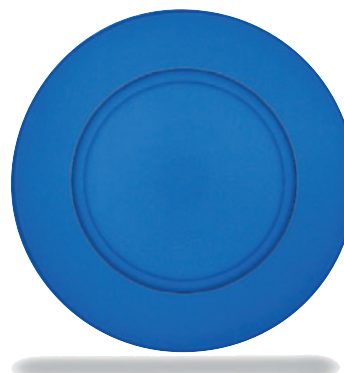

Sottopiatto
Charger
Assiette de bienvenue
Platzteller
Bajo plato

CARAMELLA Ø cm. 32 Ø 12 7/8"
" "
" "
" "

892



W Ghiaccio
Ice
Glace
Eis
Hielo



O Arancio
Orange
Orange
Orange
Naranja



G Limone
Lemon
Jaune
Zitrone
Amarillo



E Verde acido
Acid green
Vert acide
Azid Grün
Pistacho



B Anice
Anis
Bleu
Blau
Azul



U Luce di Wood
Wood light
Lumière de Wood
Schwarzlicht
Luz de Wood

Solo art. 891 - 892
Only for art. 891 - 892
Seulement pour art. 891 - 892
Nur für Art. 891 - 892
Solo para art. 891 - 892

Tutti gli articoli di pagina 348 sono disponibili in 5 colori

All the items of page 348 are available in 5 colors

Toutes les articles de page 348 sont disponibles en 5 couleurs

Alle Produkte von Seite 348 sind in 5 Farben bzw. Ausführungen erhältlich

Todos los artículos de pagina 348 son disponibles en 5 colores

Trolleys



- Carrelli multifunzionali
Vasta gamma di accessori disponibili
- Molteplici finiture
- Ruote speciali a grandezza maggiorata, fascia in gomma antistatica e antitraccia
- Angolari rinforzati
- Logo a richiesta

- Multifunctional trolleys
A complete range of optional accessories
- Numerous customization choices
- The oversized wheels are anti-static, won't leave marks.
- Reinforced legs
- Company logo on demand

- Chariots multifonctions
Complète dotation d'accessoires disponibles
- Variété de finitions
- Roulettes surdimensionnées spéciales, avec bande en caoutchouc synthétique conducteur antitraçage
- Arêtes renforcées
- Logo à la demande

- Multifunktioneller Trolley
Grosse Auswahl von optionalem Zubehör
- Grosse Auswahl von Oberflächen- Variationen und Lack-Farben
- Besonders grossdimensionierte Rollen mit antistatischen Gummireifen, die keinen Abrieb hinterlassen
- Spezialverstärkte Beine
- Ihr Firmen-Logo auf Wunsch als Option

- Carros multifunción
Vasta gama de accesorios opcionales
- Múltiples acabados
- Ruedas especiales de mayor tamaño, con cinta de goma antistática y antihuellas
- Angulares reforzados
- Logo a solicitud

MEPRÁ
S.p.A.

TROLLEYS

LONDON



Gueridon

H cm 80
cm 80 x 40

H 31 1/2"
31 1/2" x 15 3/4"

DELUXE

031



032



Massello con angolari in acciaio inossidabile 18/10
Solid wood with 18/10 Stainless Steel legs
Massif avec arêtes en inox 18/10
Massivholz, Beine mit Edelstahl Rostfrei 18/10 Profi-
len verblendet
Tablero con angulares en acero inox 18/10

VIP

036



037



Massello con angolari in massello
Trolley and solid wood legs
Panneaux massif
Trolley und Beine komplett aus Massivholz
Tablero macizo con angulares macizos

COLORI

		031 036	032 037	
		Noce Walnut Noyer Walnuss Nuez	Wengè	

TROLLEYS

HAVANA



H cm 87
cm 50 x 50

H 34 ¹/₄"
19 ³/₄" x 19 ³/₄"

DELUXE

121



122



Massello con angolari in acciaio inossidabile 18/10
Solid wood with 18/10 Stainless Steel legs
Massif avec angle en inox 18/10
Massivholz, Beine mit Edelstahl Rostfrei 18/10
Profilen verblendet
Tablero con angulares en acero inox 18/10

VIP

126



127



Massello con angolari in massello
Trolley and solid wood legs
Panneaux massif avec angles et hanches massif
Trolley und Beine komplett aus Massivholz
Tablero macizo con angulares macizos

COLORI

		121 126	122 127	
		Noce Walnut Noyer Walnuss Nuez	Wengè	

TROLLEYS

NIZZA



H cm 87 H 34 1/4"
cm 50 x 50 19 3/4" x 19 3/4"

DELUXE

091



092



Massello con angolari e maniglioni in acciaio inossidabile 18/10
Solid wood with 18/10 Stainless Steel handles and legs
Massif avec arêtes et hanches en inox 18/10
Massivholz, Beine mit Edelstahl Rostfrei 18/10 Profilen
verblendet, Griffe 18/10
Tablero con angulares y asas en acero inox 18/10

COLORI

Questo carrello comprende un inserto avvitato sul piano ed il relativo secchiello per champagne, art. 599 + art. 589 (colore a vostra scelta).

This trolley includes a screwed insert onto the top and the relative champagne cooler, art. 599 + art. 589 (color to your choice).

Ce chariot comprend un supplément vissé sur l'étagère et le relatif seau à champagne, art. 599 + art. 589 (couleur à votre choix).

Dieser Trolley einschl. fixiertem Halter für Weinkühler, art. 599 einschl. Weinkühler mit Einsatz, art. 589 (Farben zu Ihrer Wunsch).

Esto carro comprende un legajo atornillado sobre el plan y el relativo cubo por champán, art. 599 + art. 589 (color a vuestra elección).

		091	092	
		Noce Walnut Noyer Walnuss Nuez	Wengè	

TROLLEYS

LAS VEGAS



H cm 83 H 32 3/4"
cm 104 x 57 41" x 22 1/2"

DELUXE

051



052



Massello con angolari e maniglioni in acciaio inossidabile 18/10
Solid wood with 18/10 Stainless Steel handles and legs
Massif avec arêtes et hanches en inox 18/10
Massivholz, Beine mit Edelstahl Rostfrei 18/10 Profilen
verblendet, Griffe 18/10
Tablero con angulares y asas en acero inox 18/10

VIP

056



057



Massello con angolari e maniglioni in massello
Trolley and solid wood handles and legs
Panneaux massif avec angles et hanches massif
Trolley und Beine komplett aus Massivholz
Tablero macizo con angulares y asas macizas

COLORI

		051 056	052 057	
		Noce Walnut Noyer Walnuss Nuez	Wengè	

TROLLEYS

DALLAS



H cm 83 H 32 3/4"
cm 104 x 57 41" x 22 1/2"

DELUXE

041



042



Massello con angolari e maniglioni in acciaio inossidabile 18/10
Solid wood with 18/10 Stainless Steel handles and legs
Massif avec arêtes et hanches en inox 18/10
Massivholz, Beine mit Edelstahl Rostfrei 18/10 Profilen
verblendet, Griffe 18/10
Tablero con angulares y asas en acero inox 18/10

VIP

046



047



Massello con angolari e maniglioni in massello
Trolley and solid wood handles and legs
Panneaux massif avec angles et hanches massif
Trolley und Beine komplett aus Massivholz
Tablero macizo con angulares y asas macizas

COLORI

		041 046	042 047	
		Noce Walnut Noyer Walnuss Nuez	Wengè	

TROLLEYS

MIAMI



H cm 82
cm 80 x 91

H 32 1/4"
31 1/2" x 35 7/8"

DELUXE

106

107



Massello con angolari in acciaio inossidabile 18/10
Solid wood with 18/10 Stainless Steel legs
Massif avec angle en inox 18/10
Massivholz, Beine mit Edelstahl Rostfrei 18/10
Profilen verblendet
Tablero con angulares en acero inox 18/10

VIP

COLORI

101

102



Massello con angolari in massello
Trolley and solid wood legs
Panneaux massif avec angles et hanches massif
Trolley und Beine komplett aus Massivholz
Tablero macizo con angulares macizos

		101 106	102 107	
		Noce Walnut Noyer Walnuss Nuez	Wengè	

TROLLEYS



MANIGLIA

Maniglione a scomparsa, regolabile in altezza, per la corretta postura della schiena durante la movimentazione.

HANDLE

The foldaway handle can be ergonomically adjusted to the height of the user during transport.

POIGNÉE

Poignée disparible, réglable en hauteur, pour la posture correcte du dos pendant le mouvements.

SCHIEBEGRIFF

Der einklappbare Schiebegriff kann ergonomisch exakt auf die passende Höhe des Fahrers eingestellt werden, die er zum jeweiligen Transport benötigt.

AGARRADOR

Agarrador abatible, ajustable en altura, para una correcta postura de la espalda durante el uso.



HOT BOX

Contenitore Hot Box elettrico a 4 scomparti, con termostato regolabile fino a 90° C. Diametro massimo dei piatti inseribili: 31 cm.

HOT BOX

Electric Hot Box compartment, 4 compartments with adjustable thermostat up to 194° F. Maximum inner dimension:: 12 1/4".

HOT BOX

Récipient Hot Box électrique aux 4 compartiments, avec thermostat réglable jusqu'à 90° C. Maximum diamètre des plats insertables: 31 cms.

HOT BOX

Elektrisch betriebene HOT BOX mit 4 Abteilungen, mit jeweils Nutzfläche bis zu 31 cm Durchmesser. Die HOT BOX ist ausgestattet mit einem regelbaren Thermostat bis zu 90° C.

HOT BOX

Contenedor eléctrico de 4 compartimentos, con termostato ajustable a 90° C. Diámetro máximo de los platos insertables: 31 cm.



PIANO SUPERIORE ESTENSIBILE

Piano superiore estensibile "a tavolino", massima estensione cm. 92 x 80

EXTENDABLE UPPER SURFACE

Upper surface can be extended up to 36 1/4" x 31 1/2"

PLAT SUPÉRIEUR EXTENSIBLE

Plat supérieur extensible, meilleure étendue cm. 92 x 80.

AUSKLAPPBARE TISCHFLÄCHE

Die Tischfläche kann durch Ausklappen vergrößert werden auf das Mass von 92 x 80 cm.

PLANO SUPERIOR EXTENSIBLE

Plano superior extensible, medida total extendida 92 x 80 cm.

TROLLEYS



SCOMPARTI
Scomparti portabottiglie e bicchieri.

COMPARTMENTS
Compartments for wine bottles, glasses and stemware are also available.

COMPARTIMENTS
Compartiments portebouteilles et verres.

FÄCHER
Fächer für Weinflaschen, Becher und Stielgläser sind ebenfalls erhältlich.

COMPARTIMENTOS
Compartimentos para botellas y vasos.



CARATTERISTICHE
Alta resistenza, massima maneggevolezza, ruote maggiorate ed antistatiche.

FEATURES
Durable oversized casters feature maximum maneuverability with non-tracking and non-conductive rubber wheels.

CARACTÉRISTIQUES
Haute résistance, meilleure maniabilité, roues augmentées et antistatiques.

BESONDERHEITEN
Die groß-dimensionierten, robusten Rollen aus antistatischem Gummi-Material erlauben eine hochgrade Beweglichkeit, selbst bei der Überwindung schwierigster Hindernisse und unterschiedlichsten Bödenbelägen.

CARACTERÍSTICAS
Alta resistencia, máxima manejabilidad, ruedas grandes y antiestáticas.

HOT BOX
Contentitore Hot Box elettrico a 4 scomparti, con termostato regolabile fino a 90° C. Diametro massimo dei piatti inseribili: 31 cm.

HOT BOX
Electric Hot Box compartment, 4 compartments with adjustable thermostat up to 194° F. Maximum inner dimension:: 12 1/4".

HOT BOX
Récipient Hot Box électrique aux 4 compartiments, avec thermostat réglable jusqu'à 90° C. Maximum diamètre des plats insertables: 31 cms.

HOT BOX
Elektrisch betriebene HOT BOX mit 4 Abteilungen, mit jeweils Nutzfläche bis zu 31 cm Durchmesser. Die HOT BOX ist ausgestattet mit einem regelbaren Thermostat bis zu 90° C.

HOT BOX
Contenedor eléctrico de 4 compartimentos, con termostato ajustable a 90° C. Diámetro máximo de los platos insertables: 31 cm.

110



DELUXE - VIP



H cm 5,5

H 2 1/4"

Tutte le versioni Deluxe e Vip hanno la struttura in massello e il piano superiore in massello listellare. Colori optional: faggio, ciliegio, rovere e mogano.

All the wood components for the Deluxe and Vip versions are made from solid wood and the workspace top is made from heavy duty solid Block Wood Available colors: Beachwood, Cherry, Oak and Mahogany

Toutes les versions Deluxe et Vip ont la structure en massif et le plan supérieur en massif. Couleurs facultatif: Hêtre, Cerise, Chêne et Acajou.

Alle Ausführungen für die Deluxe- und VIP-Versionen sind hergestellt aus massivem Holz und die oberen Arbeitsbereiche aus strapazierfähigem, solidem Blockholz
Verfügbare Farben: Buche, Kirsche, Eiche und Mahagoni

Todas las versiones "Deluxe" y "Vip" tienen la estructura en tablero macizo y el plano superior en tablero macizo listelar
Colores disponibles: Haya, Cerezo, Roble y Caoba

RICAMBI



cm 15,5 x 7,5
H cm 2

6" x 2 7/8"
H 1"

Piastre eutettiche senza evaporatore, disponibili per tutte le cupole: congelate a -21°C, durano fino a tre ore.

Eutectic cooling plates without evaporator are available for all of the roll-top covers. Refrigerated to -5,8°F, they will keep cool for approximately 3 hours.

Bacs eutectiques sans évaporateur, sont disponibles pour toutes les lavallières: réfrigérée à -21° C, ils durent jusqu'à trois heures.

Eutektische Kühlplatten ohne Verdampfer, für alle Roll-top Aufsatz erhältlich: vor dem Gebrauch, im Gefrierschrank mit -21°C abkühlen; damit verfügen Sie über 3 Stunden Kühlleistung.

Planchas eutecticas sin vaporizador, disponibles para todas las cúpulas: congeláis a -21°C, duran hasta tres horas.

800



H cm 29
cm 11 x 11

H 11 3/8"
4 1/2" x 4 1/2"

Campionario colore per sala esposizione
Colori disponibili: noce, wengè, bianco, nero e oro.

Color Displayer for show room
Available colors: walnut, wenge, gold, black and white.

Couleur Displayer pour show room
Couleurs disponibles: Noyer, Wenge, Blanc, Noir et Or.

Farben Displayer für Show-Room
Erhältliche Farben: Walnuss, Wenge, Weiss, Schwarz und Gold.

Color Displayer para sala de exposiciones
Colores disponibles: Nogal, Wenge, Blanco, Negro y Oro.

ACCESSORI

219

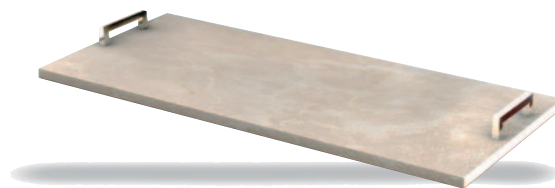

cm 83 x 36
H cm 2

32 3/4" x 14 1/4"
H 1"

Piano in marmo granito, perfettamente levigato e lucidato.

Perfectly ground and polished granite marble top surface.

Plan en marbre granulé, parfaitement lissé et poli.

Polierte Granit-Marmor-Platte mit perfekt glatt geschliffener Oberfläche.

Plano en mármol granito, perfectamente pulido.

TROLLEYS

PARIS

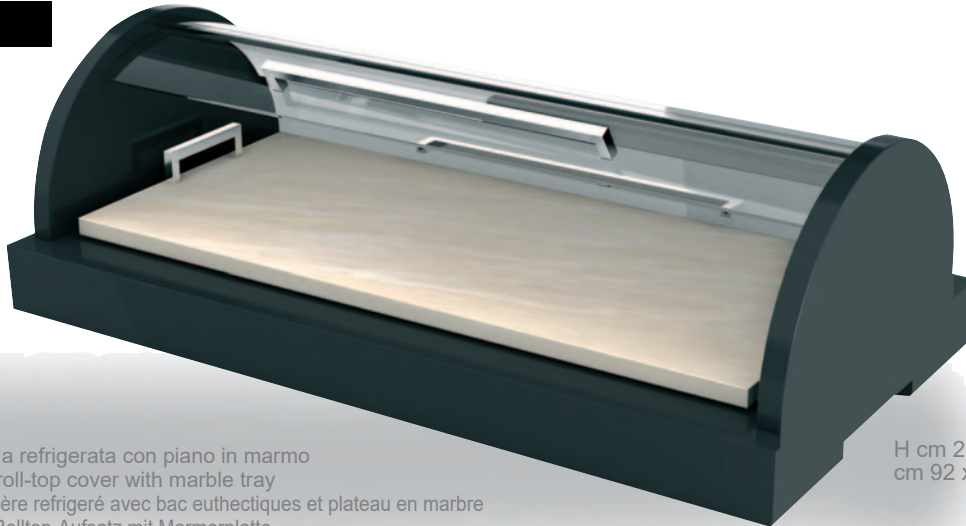

Cupola refrigerata con piano in marmo
Cool roll-top cover with marble tray
Lavallière réfrigéré avec bac eutectiques et plateau en marbre
Kühl-Rolltop-Aufsatz mit Marmorplatte
Cúpula refrigerada con plano en mármol

H cm 26,5
cm 92 x 47

H 10 1/2"
36 1/2" x 18 1/2"

DELUXE

161

162

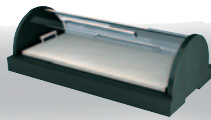
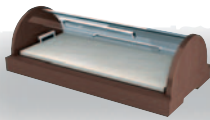

Massello
Solid wood
Massif
Massivholz
Tablero macizo

225

COLORI



- 2 Piastre eutettiche senza evaporatore sono già inserite nella cupola refrigerata
- 2 Eutectic cooling plates without evaporator are already inserted into the roll-top cover
- 2 Bacs eutectiques sans évaporateur sont déjà insérés dans la lavallière
- 2 Bereits eingelegte Kühlaccus gehören mit zum Lieferumfang
- 2 Planchas eutecticas sin vaporizador son ya insertadas en la cúpula refrigerada

		161	162	
		Noce Walnut Noyer Walnuss Nuez	Wengè	

TROLLEYS

WIEN

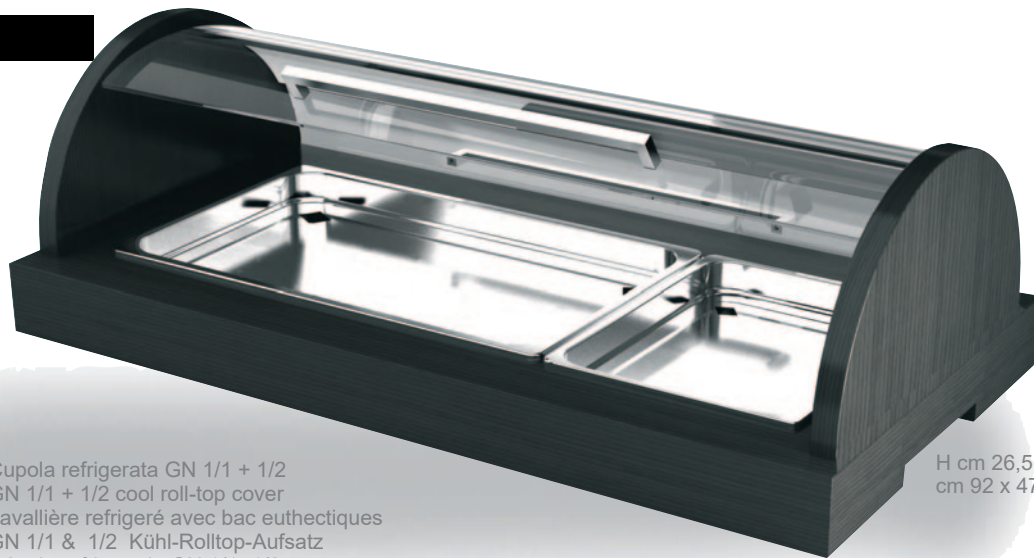

Cupola refrigerata GN 1/1 + 1/2
GN 1/1 + 1/2 cool roll-top cover
Lavallière réfrigéré avec bac eutectiques
GN 1/1 & 1/2 Kühl-Rolltop-Aufsatz
Cúpula refrigerada GN 1/1 -1/2

H cm 26,5
cm 92 x 47

H 10 1/2"
36 1/4" x 18 1/2"

DELUXE

141

142

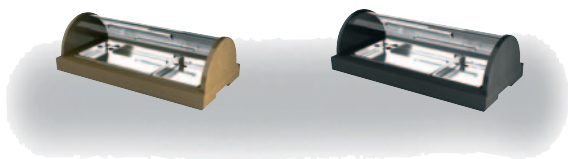

Massello
Solid wood
Massif
Massivholz
Tablero macizo

225

COLORI



- 2 Piastre eutettiche senza evaporatore sono già inserite nella cupola refrigerata
- 2 Eutectic cooling plates without evaporator are already inserted into the roll-top cover
- 2 Bacs eutectiques sans évaporateur sont déjà insérés dans la lavallière
- 2 Bereits eingelegte Kühlaccus gehören mit zum Lieferumfang
- 2 Planchas eutecticas sin vaporizador son ya insertadas en la cúpula refrigerada

		141	142	
		Noce Walnut Noyer Walnuss Nuez	Wengè	

TROLLEYS

TEVERE



H cm 80 H 31 1/2"
cm 80 x 40 31 1/2" x 15 3/4"

302



Pannello nobilitato in essenza
Laminated panel
Panneaux noble
Lackierte Paneele
Tablero lacado

309



Pannello nobilitato in essenza
Laminated panel
Panneaux noble
Lackierte Paneele
Tablero lacado

COLORI

302		309
Wengè		Castagno chiaro Light chestnut Châtain clair Heile Kastanie Castaño claro

TROLLEYS

MISSISSIPPI



H cm 85
cm 98 x 57

H 33 1/2"
38 3/8" x 22 3/8"

332



Pannello nobilitato in essenza
Laminated panel
Panneaux noble
Lackierte Paneele
Tablero lacado

339



Pannello nobilitato in essenza
Laminated panel
Panneaux noble
Lackierte Paneele
Tablero lacado

COLORI

332		339
Wengè		Castagno chiaro Light chestnut Châtain clair Heile Kastanie Castaño claro

TROLLEYS

RENO



H cm 85 H 33 1/2"
cm 50 x 50 19 3/4" x 19 3/4"

322



Pannello nobilitato in essenza
Laminated panel
Panneaux noble
Lackierte Paneele
Tablero lacado

329



Pannello nobilitato in essenza
Laminated panel
Panneaux noble
Lackierte Paneele
Tablero lacado

COLORI

322		329
Wengè		Castagno chiaro Light chestnut Châtain clair Heile Kastanie Castaño claro

Alta resistenza al graffio per il normale utilizzo

High resistance to scratch for normal use
 Hautes résistance aux griffures
 Kratzfest bei normalem Gebrauch.
 Alta resistencia a las rayas resultantes del uso normal

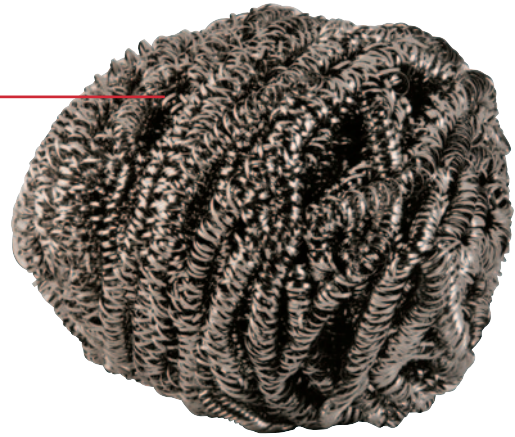

Idrorepellente non cambia colore a contatto con liquidi e cibi

Hydro repellent, it doesn't change colour when in contact with liquids or foods.
 Matière ne subissant aucunes agressions exterieurs, liquide et autres.....
 Wasserfest, keine Farbveränderung bei Kontakt mit Flüssigkeiten oder Esswaren.
 Repelente al agua, no cambia de color al entrar en contacto con líquidos y alimentos.



**Ruote speciali a grandezza maggiorata, fascia in gomma antistatica e antitraccia.
 Ruote e struttura potenziate ad alta portata**

The oversized wheels are antistatic, won't leave marks.
 Wheels and enhanced high-range structure.
 Roulettes surdimensionnées spéciales, avec bande en caoutchouc synthétique conducteur antitrace.
 Roues et roulements adaptées en fonction du poids de la table roulante.
 Besonders grossdimensionierte Rollen mit antistatischen Gummireifen, die keinen Abrieb hinterlassen.
 Die Rollen und das Gefüge verstärkte sind, um grössere Fähigkeit zu tragen.
 Ruedas especiales de mayor tamaño, con cinta de goma antistatica y antihuellas.
 Ruedas y estructura mejoradas de alta capacidad.

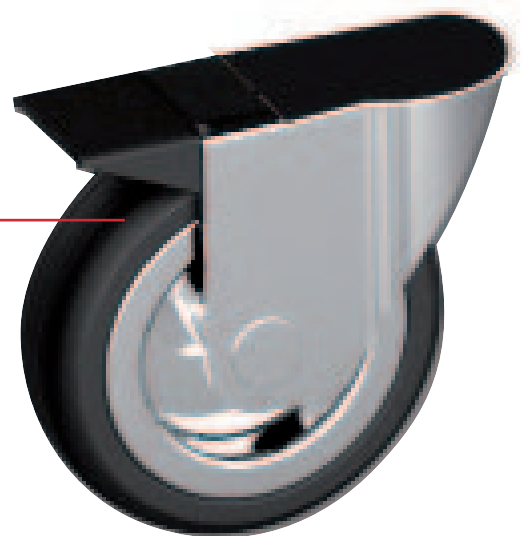



Ambiente Environment



Da molti anni MEPRA ha a cuore la salute dell'ambiente e dei lavoratori e l'uso sostenibile delle risorse ambientali, spesso anticipando di decenni le normative europee sul lavoro e sull'ambiente, investendo e puntando su impianti sempre più sicuri, alla ricerca di materiali e prodotti ausiliari sempre meno pericolosi, a garanzia della sicurezza e della salute del personale addetto e della comunità all'interno della quale l'azienda opera. Nei primi anni '80 del secolo scorso, gli impianti di lavaggio dei manufatti intermedi e finiti che utilizzavano solventi clorurati, vengono interamente rimpiazzati da impianti automatici che utilizzano sgrassanti a base acquosa (tunnel di lavaggio a tappeto). Nello stesso periodo gli impianti di pulitura e lucidatura della posateria manuali, vengono sostituiti da macchinari automatici a ciclo continuo, dotati di impianti di aspirazione e di abbattimento polveri. Negli anni '90, MEPRA, sempre più attenta alle tematiche ecologiche, trasforma i suoi impianti di lavaggio con soluzioni sgrassanti a base acquosa, che utilizzano e scaricano l'acqua per il lavaggio dei pezzi, in impianti che riciclano interamente le acque di lavaggio, filtrandole e re-immettendole nel ciclo senza alcuno scarico negli impianti fognari. Nel 1999 MEPRA con spirito innovativo si proietta verso il futuro, dotandosi di un sistema energetico altamente tecnologico; viene infatti installato un impianto di COGENERAZIONE. Viene utilizzato il metano come combustibile pulito, si genera elettricità per l'uso interno, si recupera il calore sprigionato dalla produzione elettrica, per il riscaldamento dei cicli produttivi che assorbono calore ed inoltre per il riscaldamento ambientale durante l'inverno, in modo da diminuire drasticamente l'inquinamento atmosferico prodotto dai gas serra. MEPRA rifiuta categoricamente ogni forma di sfruttamento del lavoro minorile ed investe ogni giorno per offrire alle nuove generazioni un futuro migliore, collaborando con le università e le scuole secondarie della comunità locale per formare i manager e i tecnici del futuro e per sostenere il mantenimento e l'accrescimento della cultura del lavoro, dei valori e delle competenze professionali che rappresentano una delle caratteristiche peculiari del distretto industriale all'interno del quale l'azienda opera.

Since many years MEPRA cares about the health of workers and the environment and sustainable use of environmental resources, often decades ahead of European regulations on labor and environment. Mepra invests and focus on safer and safer equipments, looking for materials and auxiliary products less and less dangerous, to guarantee safety and health of the workers as well as the community within which it operates. In the early 80s of last century, the washing equipment, previously based on chlorinated solvents, are entirely replaced by automatic systems that use water-based washing tunnels. In the same period the hand operated cutlery cleaning and polishing machineries, are replaced by continuous loop automatic machines, equipped with suction pumps and dust abatement equipment. In the '90s, MEPRA, more and more careful about the environment, converts washing systems previously using water-based degreasing solutions that were filtered and discharged into the sewers, into equipments that recycle the wastewaters by filtering and re-pumping them in the washing cycle without any waste in sewage plants. MEPRA in 1999 with an innovative spirit is projected into the future, adopting a high-tech energy system, a cogeneration system is in fact installed. It uses natural gas as clean fuel, electricity can be generated for internal use, it re-uses the heat generated from electricity production in production cycles and also for heating the plant during the winter, in order to drastically reduce carbon emissions. MEPRA categorically rejects all forms of child labor and invest every day to offer the new generations a better future, working with universities and secondary schools in the local community to train managers and technicians of the future and to carry-on work culture, values and skills that represent one of the characteristics of the industrial district in which the company operates.



CERTIFICATO DI SISTEMA DI GESTIONE

Certificato n.
10000371372-MSC-ACCREDIA-ITA

Data Prima Emissione:
28 agosto 2020

Validità:
28 agosto 2023 - 27 agosto 2026

Si certifica che il sistema di gestione di
Mepra S.p.A.
Via Virgilio Montini, 176 - 25067 Lumezzane (BS) - Italia

È conforme allo Standard:
ISO 9001:2015

Questa certificazione è valida per il seguente campo applicativo:
Progettazione, produzione e commercializzazione di: posateria, pentolame, vasellame ed oggettistica in acciaio inox per la tavola e la cucina per uso domestico, Hotel, Ristoranti e Catering (IAF 17)

Luogo e Data:
Vimercate (MB), 11 agosto 2023



10000371372-MSC-ACCREDIA-ITA
10000371372-MSC-ACCREDIA-ITA
10000371372-MSC-ACCREDIA-ITA
10000371372-MSC-ACCREDIA-ITA

Per l'Organismo di Certificazione:
DNV - Business Assurance
Via Energy Park, 14 - 20871 Vimercate (MB) - Italy

Claudia Baroncini

Claudia Baroncini
Management Representative

Il mancato rispetto delle condizioni stabilite nel regolamento di certificazione potrebbe invalidare il certificato.



MANAGEMENT SYSTEM CERTIFICATE

Certificate no.
10000371372-MSC-ACCREDIA-ITA

Initial certification date:
28 August 2020

Valid:
28 August 2023 - 27 August 2026

This is to certify that the management system of
Mepra S.p.A.
Via Virgilio Montini, 176 - 25066 Lumezzane (BS) - Italy

has been found to conform to the Quality Management System standard:
ISO 9001:2015

This certificate is valid for the following scope:
Design, production and commercialization of: flatware, cookware, serverware and items in stainless steel for the table and kitchen for domestic use, Hotels, Restaurants and Catering (IAF 17)

Place and date:
Vimercate (MB), 11 August 2023



10000371372-MSC-ACCREDIA-ITA
10000371372-MSC-ACCREDIA-ITA
10000371372-MSC-ACCREDIA-ITA
10000371372-MSC-ACCREDIA-ITA

For the issuing office:
DNV - Business Assurance
Via Energy Park, 14 - 20871 Vimercate (MB) - Italy

Claudia Baroncini

Claudia Baroncini
Management Representative

Lack of fulfillment of conditions as set out in the Certification Agreement may render this Certificate invalid.
ACCREDITED UNIT: DNV Business Assurance Italy S.r.l. - Via Energy Park, 14 - 20871 Vimercate (MB) - Italy - TEL: +39 03 99 905 - www.dnv.it

Abbiamo a cuore l'ambiente e il futuro del genere umano
Sin dal 1947 Mepra si trova ai piedi delle Prealpi Italiane. Siamo cresciuti e viviamo ogni giorno in simbiosi con le nostre montagne, abbiamo a cuore i nostri alberi, le nostre acque e l'aria che noi e i nostri figli respiriamo.

Nella lotta al cambiamento climatico ogni voce conta, anche la più piccola, in ogni angolo del mondo, e sentiamo la responsabilità di fare la nostra parte per assicurare un futuro migliore al pianeta.

Riduzione delle Emissioni di CO2

Con l'obiettivo di ridurre drasticamente le emissioni di CO2 Mepra si è impegnata ad installare un impianto fotovoltaico per produrre oltre 160.000 KWh all'anno e ridurre di conseguenza le emissioni di CO2 di 84.000 Kg. Il fabbisogno energetico residuo, nei mesi invernali, viene prodotto, per la maggior parte, con un sistema di cogenerazione. Questo impianto produce elettricità e, allo stesso tempo, il calore necessario per il riscaldamento dei locali aziendali, con un significativo risparmio energetico.

Riciclo

La maggior parte dell'acciaio utilizzato da Mepra nel processo produttivo proviene da fonti riciclate

Tutto lo scarto di produzione viene riciclato per produrre nuova materia prima

Gestione e recupero dei rifiuti

Mepra è da anni impegnata nella raccolta differenziata, non solo degli imballaggi, ma di tutti i rifiuti prodotti in azienda.

Conservazione delle risorse idriche

Dai primi anni '90 Mepra utilizza, all'interno del suo ciclo produttivo, un sistema di recupero dell'acqua di lavaggio e dei detergenti che vengono filtrati e re-immessi nel ciclo idrico senza alcuno scarico negli impianti fognari.

Utilizzo di sostanze non inquinanti:

Già dai primi anni '80, gli impianti di lavaggio dei manufatti intermedi e finiti che utilizzavano solventi clorurati, sono stati interamente rimpiazzati da impianti automatici che utilizzano sgrassanti a base acquosa (tunnel di lavaggio a tappeto).

Depurazione dell'aria

Nello stesso periodo gli impianti manuali di pulitura e lucidatura della posateria, sono stati sostituiti da macchinari automatici a ciclo continuo, dotati di impianti di aspirazione e di abbattimento polveri.

We have the future of the environment and the human species at heart

Since 1947 Mepra has been located at the foothill of the Italian pre Alps. We grew with and live in symbiosis with our mountains, day in day out, we care for our trees, our waters and the air we and our children breathe. In the fight against climate change every voice counts, even the faintest one, in every corner of the earth, and we feel the responsibility to play our part to ensure a better future for our planet.

Reduction of CO2 emissions

In the quest of drastically reducing CO2 emissions, Mepra has been working hard on the installation of a photovoltaic plant to produce more than 160.000 KWh per year, thus reducing CO2 emissions by 84.000 Kg.

The residual energy requirement in the winter months is produced for the most part by a cogeneration system that at the same time produces electricity and the necessary heat to heat up the offices, resulting in a significant energy saving.

Recycling

The majority of the steel used by Mepra in the production process comes from recycled sources. All the production waste is recycled to produce new raw material.

Waste management and recovery

For years Mepra has been practicing differentiated waste collection, not only with packaging, but all waste produced by the company.

Conservation of water resources

Since the early '90s Mepra uses a system that recovers the washing water and detergents used in production, by filtering them and re-introducing them in the water cycle without any discharge into the sewage system.

Use of non-polluting substances

Since the beginning of the 80's the washing machinery of the intermediate or finished products that used chlorinated solvents have entirely been replaced by automated machinery that use water-based degreasers.

Air purification

Always in the 80's the cleaning and polishing machinery used for cutlery have been replaced by automated loop machines equipped with dust suction and elimination systems.

B O B

BOB

AIUTA IL NOSTRO PIANETA
RIDUCI LA PLASTICA

Abbiamo creato una nuova linea di bottiglie riutilizzabili per garantire un futuro ai nostri oceani.

Per questo motivo il nome 'BOB = Blue Ocean Bottle', un progetto che ci aiuterà a ridurre l'utilizzo della plastica eliminando il consumo di bottiglie quotidiane.

BOB non è una semplice bottiglia termica, è l'esempio perfetto di utilità e eleganza fusi insieme.

We have created a new line of reusable bottles to grant a future to our oceans.

Hence the name "BOB = Blue Ocean Bottle", a project that will help us reduce the use of plastic by eliminating the consumption of daily plastic bottles. BOB is not a simple thermal bottle, it is the perfect example of utility and elegance fused together.

Perchè scegliere BOB? Why BOB?



Aiuta la salvaguardia dei nostri oceani.
Helps safeguard of our oceans.



Ferma il single use delle bottiglie di plastica.
Stops the single use of plastic bottles.



Diminuisce i batteri ingeriti che si annidano nelle bottiglie di plastica.
Reduces the ingested bacteria lurking in plastic bottles.



Durabilità nel tempo.
Longevity over time



Grazie al suo molteplici utilizzo, è un ottima scelta per risparmiare denaro.
Can be used multiple times and is an excellent way to save money.



BLUE OCEAN BOTTLE

BOB è una bottiglia termica di capacità 0,5 litri. Grazie alla doppia camera in acciaio inossidabile, mantiene la temperatura della bevanda calda 12h e fredda fino a 24h.

BOB è in grado di contenere qualsiasi bevanda, dall'acqua ai succhi di frutta, senza rischio di corrosioni o alterazioni.

BOB is a thermal bottle with 0.5 liter capacity . Thanks to its double stainless steel chamber, it keeps the hot temperature for 12 hours and the cold one for up to 24 hours.

BOB is able to hold any drink, from water to fruit juices, without the risk of corrosion or alterations.



Chiusura Termica

Thermal Closure

Bilaminato acciaio e rame

Bi-laminated steel and copper

Camera sotto vuoto

Vacuum room

Corpo esterno di protezione

External protection body

Triplo fondo

Triple bottom



COLORI DISPONIBILI
 AVAILABLE COLORS
 COULEURS DISPONIBLE
 VERFÜGBARE FARBEN
 COLORES DISPONIBLE:

W
 Bianco
 White
 Blanc
 Weiss
 Blanco



O7
 Arancio
 Orange
 Orange
 Orange
 Naranja



S7
 Rosso
 Red
 Rouge
 Rot
 Rojo



693

BOB
 Bottiglia termica
 Insulated bottle
 Bouteille thermique
 Isolier Flasche
 Botella térmica

lt. 0,5
 oz. 16 7/8

H7
 Lilla
 Lilac
 Lilas
 Lila
 Lila



Q7
 Oliva
 Olive
 green
 Olive
 Olivegrün
 Oliva



D7
 Lavanda
 Lavendal
 Lavande
 Lavendal
 Lavanda



O
 Oro
 Gold
 Or
 Gold
 Oro



B
 Rame
 Copper
 Cuivre
 Kupfer
 Cobre



N
 Nero
 Black
 Noir
 Schwarz
 Negro



You can save the oceans too, one bottle at a time!





INDICE

INDEX

INDEX

ALPHABETISCHES REGISTER

INDICE

NUMERI

RESTAURANT
HOTEL

Indice

A B	Pag
Agitatore	301
Agitatore Boston	301
Allacciatovaglioli	130 259
Alzata dolci	173 177 216 217 220 221 227 266 288
Alzata pane	234 235 289
Alzata pesce crudo	158 159 160 223 231
Alzata portafrutta	158 159 216 217 220 231 266
Alzata portapiatti	221 287
Alzata torta	173 177 216 230 266
Ampolla	219 239 242 268
Antipastiera	248 258
Appoggia borse	284
Appoggia chop sticks	82
Appoggia posate	84 102 173 177 195 209
Apribottiglie	282
Apriostriche	160
Base per buffet	196 197
Bicchiere	154 178 202 206 340 341 346
Big champagnera	310
Bistecchiera	333
Bollilatte	337
Bottiglia termica	368 <> 371
Braciere con griglia	242 244
Bricco	147 293
Brocca per acqua	294 0
Bugia	227 0

C	Pag
Caffettiera	220 291 292 294 295 296
Caffettiera termica	291 292 296
Candelabro	221 227
Caraffa per bibite	199 291 292 294
Caraffa termica	291 292
Carrello portavivande	348 <> 362
Casseruola	322 324 326 331 334
Cavatappi	282
Centrotavola	155 158 159 161 189 202
Cestino	125 126 128 129 130 135 146 149 150 151 152 153 155 172 174 176 177 182 186 193 195 202 218 234 235 237 259 262 263 265 280 342 346
Cestino portabonbon	180 182 265
Cestino portacondimenti	135 262 277 280
Cestino portafrutta	135 146 149 150 151 152 153 155 234 237 262 265 308 309 342 346
Cestino portapane	135 146 149 150 151 186 193 195 218 234 235 237 259 262 265 280 342
Cestino portatovaglioli	193 234 289 298
Cesto porta agrumi	135 146 149 150 151 152 153 155 234 237 262 265 308 309 342 346
Chafing dish	208 210
Champagnera	152 223 233 310 314 315
Chillcup	219 238
Chop sticks	82
Ciambella termica	249 251
Ciotola in acciaio	146 216 237 277
Ciotola in legno	277
Ciotola in policarbonato	135 309 310 340 342 343
Ciotola in polipropilene	346
Cloche	221 223 224 236 251 273 276 281
Coffee Urn	209
Colapasta	337
Colino da cocktail	282
Colonna porta big champagnera	311
Colonna portasecchiello	126 128 135 153 222 232 233 302 303 304 305 306 307 309 315
Colonna portasigari	154
Coltelli	14 <> 72 86 88 104 118 160 243
Contenitore per bibite	199 209
Coperchio	224 272 274
Coperchio per legumiera e zuppiera	224 274
Coperchio per piatto ovale	272
Coppa burro	219 238
Coppa caviale	219 238
Coppa cocktail e scampi	219 238
Coppa con piede	146 147 216 218 223 237 301
Coppa con vassoio	178 180 182 219 225 238
Coppa crema/potage	274
Coppa intermezzo	100 278
Coppa in vetro	218 249
Coppa lavadita	146 276
Coppa Martini	278 341
Coppa multiservizio	218
Coppa per champagne	223 227 301
Coppa per gelato e/o macedonia	147 180 182 225 237 238 280 288 341
Coppa per pinzimonio	218 249
Coppa per punch	223 227 301
Coppa vichyssoise	219 238 274
Coppetta amouse bouche	102 178
Copripiatto	270 273
Cremiera	154 248 288 299

C	Pag
Cubetto luminoso LED	317
Cucchiaino da cocktail	14 <> 72 102 206
Cucchiaino per cappuccino	104 299
Cucchiaino per caviale	282
Cucchiaino sale	102 206
Cucchiaino agitatore	14 <> 72 104 106 299 316
Cucchiaino monoporzione	102 206
Cucchiaino multifunzione	96 163
Cucchiaino per bibita	14 <> 72 104 106 299 316
Cucchiaino per insalata	14 <> 72 106 119 209 210
Cucchiaino per miele	98
Cucchiaino per parmigiano	14 <> 72
Cucchiaino per risotto	104 106 119 209 210
Cucchiaino per salsa	14 <> 72 119 210 274
Cucchiaino servire	14 <> 72 104 106 119 209 210
Culla porta champagne	211
Cuocipasta	337
Cuociverdura	337

DEF	Pag
Distributore di latte	209
Distributore di succo di frutta	209
Dosatore sale e pepe	154
Dosatore	301
Espositore per buffet	202
Finger food	102 106 133 162 <> 167 172 176 185 195 202 206 212 94 104
Forchetta aragosta	94 104
Forchetta monoporzione	102 172 176 206
Forchetta per insalata	14 <> 72 106 119 209 210
Forchetta per lumache	104
Forchetta servire	14 <> 72 104 106 119 209 210
Forchetta servire pesce	14 <> 72 106 119
Forchettina ostriche	14 <> 72
Forchettina cocktail	102 172 176 206
Forchettone	14 <> 72 104 106 119 209 210
Formaggiera	133 219 239 259 260 262 263 265 269 276
Fruttiera	155 158 159 161 189

GHIL	Pag
Glacette termica	304
Golf club mixer spoon	104 316
Grattugia	282
Gueridon d'appoggio	308
Happy spoon	106
Infusiera	199
Inserto per cuocipasta	337
Insalatiera	146 216 237 249 342 346
Inserto per finger food	133 165
Lasagnera	249 258
Lattiera	220 291 292 294 295 296
Legumiera	224 274
Legumiera escoffier	274

MNO	Pag
Macine	283
Mestolo	14 <> 72 106 210 301
Micro forchetta	102 172 176
Micro presentoire	163 288
Mini barriera	144 225 239 264 267 277 288
Mini casseruola	322 324 326
Mini cestello	177
Mini forchetta	102 206
Mini presentoire	163 288
Mini spoon	102 206
Mini vaporiera	166
Mini vassoio	164 181 182 183 202 220
Misurino cocktail	301
Molla fonda per servire	212
Molla per aperitivi	212 293
Molla per asparagi	147 212 275
Molla per arrosto e verdure	147 212 275
Molla per dolci	212 275
Molla per Finger Food	212
Molla per frutta	212 275
Molla per ghiaccio	212 275 316
Molla per ghiaccio e limone	212
Molla per lumache	104 275 276
Molla per pane	212
Molla per pasticceria	212
Molla per servire	212 275
Molla per spaghetti	147 212 275
Molla per zucchero	212 275 293
Molla per zucchero ed aperitivi	212 293
Molla piana per servire	212
Mug	343
Numero da tavola	185 223 237 278 281
Oliera	133 225 239 259 260 262 263 265 268 269

PQR	Pag
Padella	323 325 327 331 332 336
Pala per torta	14 <> 72 106 118 209 210
Pentola	322 324 326 331 334
Petit marmite	208

Indice

PQR	Pag
Piano	130 149 150 151 189 202 206 340
Piastra ad induzione ed elettrica	208
Piastra eutettica	358 359
Piattino	171 176 238 343
Piattino per burro	264 267
Piattino per lumache	276
Piattino per mug	343
Piattino per pane	149 267
Piattino per pasticceria	179 181 182
Piattino porta monete	176 301
Piattino sottocoppa	238
Piatto concavo	193 235
Piatto da presentazione	134 146 149 151 165 186 194 257 263 264 266 283 346
Piatto da torta	218 230
Piatto ovale	144 146 270 272
Piatto per buffet	340
Piatto per legumi	146 272
Piatto per ostriche	158 159 161
Piatto pesce	144 270
Piatto quadrato	150 202 248
Piatto rotondo	144 146 206 251 270 272 340
Piatto termico	251
Pietra ollare	242
Pinza aragosta	104
Pinza per antipasti e dolci	212 275 293
Pinza per dolci	212 275
Pinza per servire	147 212 275
Pinza per torta	212 275
Pinza per verdure	147 212 275
Pirofile e porcellane	249 258
Poggia pane	178
Porta badge	281
Porta bastoncini di zucchero	298
Porta bicchieri	259
Porta bottiglie	277 279
Porta burro e marmellata	277 299
Porta bustine da zucchero	193 220 234 289 296 298 299
Porta cannucce	316
Porta condimenti	135 262 277 280
Porta cono gelato	165 242
Porta crackers	178
Porta cucchiaini	301
Porta gioie	170 176
Porta grissini	151 178 186 193 195 279
Porta macarons	219 267 288
Porta marmellata	225 269 299
Porta menù	223 237
Porta noccioli	133 236
Porta numero	185 223 237 278 281
Porta pane porta grissini	151 178 185 186 193 195 279
Porta pasticcini	216 217 227 266 288
Porta patatine fritte	165 242 278
Porta piatti	221 259 287
Porta salatini	219 287 342 343
Porta salse	280
Porta salviettine	299
Porta sapone	299
Porta sigari	154
Porta sorpresa	170 176
Porta spazzolini	301
Porta spezie	258
Porta stuzzicadenti	185 195 219 225 234 239 268 269 274 280
Porta tacos	279
Porta toast	278 288
Porta tovaglioli	192 193 234 258 289 298
Porta uovo	144 277
Porta vivande	208 210
Portaghiaccio termico	232 304 305 306
Posacenere	151 154 276
Posate	14 <-> 72 86 88 96 98 102 104 106 118 119 160 163 176 206 209 210 243 274 282 299 301
Presentoire	163 221 227 287 288 289
Quarta posata	90 <-> 93 163 175
Rechaud	208 210
Rinfresca macedonia	223
Rinfrescatore per yogurt	210 223
Rinfrescavino bianco	304 305 307
Risottiera	258 320 324 326 331 333

S	Pag
Salino	219 269
Salsiera	144 274
Salvagoccia	279
Saucière	144 178
Sauteuse	246
Schiaccianoci	282
Scodella lavadita	146 276
Secchiello per ghiaccio	146 152 153 222 232 301 302 303 304 305 306 308 314 316 317 346
Secchiello per ghiaccio termico	232 304 305 306
Secchiello per spumante	126 146 152 153 186 222 232 301 302 303 304 305 306 307 308 309 310 314 316 317 342 346

S	Pag
Segnaposto	278
Servizio per antipasto	219
Servizio per caffè	224 293
Servizio per caviale	238
Servizio per champagne	305
Servizio per latte macchiato	299
Servizio per olio e aceto	262 277 280
Servizio per pinzimonio	249
Servizio per zucchero	225 267 287 293
Set impilabile	342 343
Set per aperitivi	133
Set per ceviche	281
Set sale e pepe	154 225 239 268 269 274
Sottobicchiere	257 264 267
Sottobottiglia	185 186 195 257 264 267 283
Sottopiatto	134 146 149 151 165 186 194 257 263 264 266 283 346
Spaghiettiera	337
Spargipepe	154
Spargisale	154 219 225 239 268 269 274
Spumantiera	152 233 310 314 315
Street cover	138 140
Supporto	248 249
Supporto per informazioni	223 237

T V W Z	Pag
Taglia tartufi	283
Tazza	343
Tegame	320 324 326 331 333 334
Tegamino friggiuova	147 276
Teiera	220 291 292 294 295 296
Teiera termica	296
Tiffin' box	252
Tovaglietta americana	134 138 140 185 194
Trolley	348 <-> 363
Tubo per ghiaccio	199
Tumbler	178
Vaporiera	166
Vasetto portafiori	283
Vaso	171 176 346
Vassoietto	181 182 183 220
Vassoio	123 133 134 144 150 158 159 161 164 165 175 177 179 180 181 182 185 186 189 192 194 195 202 206 209 215 218 228 229 230 234 235 236 254 257 260 262 263 264 272 273 279 280 288 289 298
Vassoio concavo	279
Vassoio conto	151
Vassoio gn	185 186 194 215 228
Vassoio in carbonio	122 123
Vassoio ovale	150 159 164 189 218 230 263 273
Vassoio per carrelli	186 235 254
Vassoio petit four	179 180 181 182 183
Vassoio portabicchieri impilabile	235
Vassoio prima colazione	133
Vassoio quadrato	134 150 158 164 165 185 195 202 229 257 262
Vassoio rettangolare	123 133 134 144 150 158 164 185 186 189 192 194 195 202 206 209 215 218 228 229 230 234 235 236 254 257 260 262 263 264 272 273 279 280 288 289 298
Vassoio rotondo	159 161 175 177 215 218 229 230 236 257 260 264
Versatore per profumo	225
Vetrina (cupola) refrigerata	358 359
Wok	333 337
Zuccheriera	147 154 220 291 292 294 295 296 298 299
Zuppiera	208 224 274
Zuppiera monoporzione	274

Index

A B

	Pag
Accessories	82 <> 107
Afternoon tea stand	221 287
Amenities tray	133 134 135 165 186 234 289 299
Appetizer bowl	133 178
Appetizer set	133
Asparagus tongs	147 212 275
Bags support	284 285
Bar spoon	104 106 299 316
Basket for aromatic condiments	260 277 280
Beverage server	199 291 292 293 294
Beverage server, insulated	291 292
Big wine party tub	152 223 233 310 314 315
Boston shaker	301
Bottle cooler	304
Bottle, insulated	368 <> 371
Bottle opener	282
Bottle stand/coaster	185 186 195 254 262 264 283
Bowl	146 149 150 151 177 178 182 202 216 218 225 235 237 259 277 309 340 342 343 346 309 310 342
Bowl, small	102 146 178 180 216 218 237 277 342 343 346
Bread basket	135 146 149 150 151 186 193 195 218 234 235 237 259 262 265 280 342
Bread plate	149 267
Bread stand	192 234 289
Bread/Pastry tongs	212
Breakfast tray	133
Buffet rack	202 340
Buffet showcase, cooled	358 359
Butter cup and dish	219 238 264 267 277 299

C

Caf� au lait set	224 293 299
Cake server	14 <> 72 106 118 209 210
Cake stand	173 177 216 217 220 221 227 266 288
Candlestick	221 227
Carbon fiber tray	122 123
Carving fork	16 <> 72 104 119
Cash tray	176 301
Caviar cup	219 238
Caviar set	238
Caviar spoon	282
Casserole	322 324 326 331 334
Centerpiece	155 158 159 161 189 202
Ceviche set	281
Chafing dish	208 210
Champagne bowl	152 223 233 310 314 315
Champagne bowl stand	126 128 135 153 222 232 233 302 303 304 305 306 307 309 315
Champagne bucket	126 146 152 153 186 222 232 301 302 303 304 305 306 307 308 309 310 314 316 317 342 346
Champagne holder	211
Charger	134 146 149 151 165 186 194 257 263 264 266 283 346
Chillcup	219 238
Chilli mill	283
Chips cone holder	165 240 278
Chopsticks	82
Chopsticks rest	82
Cigar ash tray	151 154 276
Cloche	221 223 224 236 251 273 276 281
Cloche for wedding cake stand	224 236 281
Cocktail measuring cup double	301
Cocktail strainer	282
Coffee cup	343
Coffee dispenser solid alcohol heating	209
Coffee pot	220 291 292 294 295 296
Coffee pot, insulated	291 292 296
Coffee urn	209
Colander	337
Cookware	318 <> 337
Cooled juice pitcher	291 292 294
Cork screwer	282
Cover	270 273
Cover for oval meat dish	270
Cover for soup tureen and vegetable dish	270 272 273
Creamer	154 248 288 299
Cruet	219 239 242 268
Cruet set	135 225 239 259 260 261 262 263 265 268 269
Cup and tray	178 180 182 219 225 238
Cup with feet	146 147 216 218 223 237 301

DEF

Deep serving tongs	275
Dish cover	270 273
Dome cover for dish	221 223 224 236 251 273 276 281
Egg cup	144 277
Electric heating unit	208
Escargot fork	104
Escargot plate	276

DEF

Escargot tongs	104 275 276
Eutectic pads	357 358
Finger bowl	146 276
Finger food	102 106 133 162 <> 167 172 176 185 195 202 206 212
Finger food insert	133 164
Finger food tongs	212
Fish dish	144 270
Fish serving fork	14 <> 72 106 119
Fish serving knife	14 <> 72 106 119
Flat serving tongs	212
Flatware	14 <> 72 86 88 96 98 102 104 106 118 119 163 206 209 210 243 282
Flower vase	283
Food pan	204 206
French fry holder	165 241 278
Front cooking & Apartments	318 <> 337
Fruit basket	151 155 158 159 189 202
Fruit bowl	135 146 149 150 151 152 153 155 234 237 262 265 308 309 342 346
Fruit salad bowl	146 216 237 340 342
Fruit stand	158 159 216 217 220 231 266
Fruit tongs	212 275
Frying pan	323 325 327 331 332 336
Frying pan for eggs	147 276

GHIJKL

Giant champagne bucket	310
Glass	154 178 202 206 340 341 346
Glass coaster	257 264 267
Golf club mixer spoon	104 316
Grated cheese pot	133 219 239 259 260 262 263 265 269 276
Grater	282
Gravy boat	140 268
Grill	333
Gueridon	308
Happy spoon	106
Herbs mill	283
Holder	223 237 248 249
Honey spoon	98
Hors d'oeuvre tray	248 258
Hors d'oeuvre and pastry pliers	275 276
Ice and lemon tongs	212
Ice bucket	146 152 153 222 232 301 302 303 304 305 306 308 314 316 317 346
Ice bucket, insulated	232 304 305 306
Ice cream cup	147 180 182 225 237 238 280 288 341
Ice tea spoon	14 <> 72 77 106 295 312
Ice tongs	212 275 316
Intermezzo cup	100 278
Infuser jug	199
Infuser jug insert	199
Induction cooker	208
Jam and honey holder	225 269
Jar	176
Jug	147 291 292 293
Juice dispenser	209
Kitchen set	334
Knife rest	84 102 173 177 195 209
Knives	14 <> 72 86 88 104 118 160 243

Ladle	14 <> 72 106 210 301
LED Ice cubes	317
Lobster cracker	104
Lobster pick	94

MNO

Meat dish	144 270
Micro fork	102 172 176
Micro and Mini presentoire	163 288
Milk boiler	337
Milk dispenser	209
Milk pot	220 291 292 294 295 296
Mini basket	177
Mini butter dish	144 225 239 277 288
Mini casserole	322 324 326
Mini fork	102 206
Mini spoon	102 206
Mini steamer	166
Mini table stand	281
Mini tray	164 181 182 183 202 220
Mixing glass	301
Monoportion fork	102 172 176 206
Monoportion spoon	102 172 176 177 206
Mug	343
Multifunctional spoon	96 163
Multipurpose bowl	218
Napkin holder	192 193 234 258 289 298
Napkin ring	130 259
Nut-cracker	282
Oil and vinegar set	262 277 280
Oil pourer	133 225 239 259 260 262 263 265 268 269

Index

M N O

Olive seeds jar	133 236
Oval meat dish	144 146 270 272
Oval dish/china	249 258
Oyster fork	14 <> 72
Oyster plate	158 159 161

P Q R

Parmesan cheese basin	133 219 239 259 260 262 263 265 269 276
Parmesan spoon	14 <> 72
Party forks	102 172 176 206
Party spoon	14 <> 72
Pasta pot	337
Pasta pot insert	337
Pastry pliers	212 275
Pastry stand	173 177 216 217 220 221 227 266 288
Patè holder	144 225 239 288
Pepper grinder	283
Pepper shaker	154 225 239 268 269 274
Perfume drops dispenser	225
Petit four stand	173 177 216 217 220 221 231 266 287
Petit marmite	208
Pie pliers	212 275
Pinzimonio set	249
Plate cover, round	271 271 272 273
Plate, crescent	193 235
Plates	144 146 149 171 176 179 181 182 193 218 230 235 238 248 264 267 270 272 276 301 343
Pliers	104 147 212 275 276 293 316
Polycarbonate drinkware	338 <> 341
Porcelain insert	249 258
Presentoire	163 221 227 287 288 289
Punch bowl	223 227 301
Quarta Posata	90 <> 93 163 175
Relish dish	219 287 342 343
Riser	196 197
Room service system	251

S

Salad bowl	146 216 237 309 342 346
Salt and pepper set	154 225 239 268 269 274
Salt cellar	219 269
Salt grinder	283
Salt shaker	154 225 239 268 269 274
Salt spoon	102 206
Salt/Pepper dispenser	154 225 239 268 269 274
Sauce boat	144 274
Sauce bowl	280
Sauce spoon	14 <> 72 106
Saucepan	322 324 326 331 334
Saucer	171 176 238 264 267 343
Sauteuse	246
Seafood stand	158 159 160 223 231
Serving fork	14 <> 72 104 106 119 209 210
Serving pliers	147 212 275
Serving spoon	14 <> 72 104 106 119 209 210
Serving tongs	147 212 275
Set for Risotti	258
Shaker	301
Show plate	134 146 149 151 165 186 194 257 263 264 266 283 346
Small spoon	102 206
Snack server	219 287 342 343
Soapstone	242
Soap tray	299
Soup cup	274
Soup tureen	208 224 274
Spaghetti tongs	147 212 275
Square tray	134 150 158 164 165 185 195 202 229 257 262
Stackable tray	228 229 235
Stackable tray for glasses	235
Stock pot	322 324 326 331 334
Street cover	139 141
Sugar bowl	147 154 220 291 292 294 295 296 298 299
Sugar, milk and coffee set	224 293
Sugar set	224 225 267 287 293
Sugar tongs	212 275 293
Sugar and cocktails tongs	212 293
Sugar/Tea bags holder	193 220 234 289 298 299
Supreme cup	219 238

T U V W Y

Table grill	242 244
Table mat	134 138 140 185 194
Table number	185 223 237 278 281
Table number stand	185 223 237 278 281
Tacos holder	279
Tall container	125 126 128 146 153 186
Tea cup	343
Tea pot	220 291 292 294 295 296
Tea pot, insulated	296

T U V W Y

Thermal serving unit	249 251
Tiffin' box	252
Toast rack	278 288
Toast/Pastry tongs	212 275
Tongs	104 147 212 275 276 293 316
Toothpick holder	185 195 219 225 234 239 268 269 274 280
Tray	123 133 134 144 150 158 159 161 164 165 175 177 179 180 181 182 185 186 189 192 194 195 202 206 209 215 218 228 229 230 234 235 236 254 257 260 262 263 264 272 273 279 280 288 289 298
Tray for rack trolley	186 235 254
Tray gn	185 186 194 215 228
Tray, oval	150 159 164 189 218 230 263 273
Tray, rectangular	123 133 134 144 150 158 164 185 186 189 192 194 195 202 206 209 215 218 228 229 230 234 235 236 254 257 260 262 263 264 272 273 279 280 288 289 298
Tray, round	159 161 175 177 215 218 229 230 236 257 260 264
Tray, square	134 150 158 164 165 185 195 202 229 257 262
Tray with holes	177
Trolley	348 <> 363
Truffle slicer	283
Tumbler	178
Underliner	238
Vacuum jug	291 292
Vase	171 176 346
Vegetable dish	224 274
Vegetable dish escoffier	274
Vegetable/Meat tongs	147 212 275
Vegetable pliers	147 212 275
Vegetable steamer	337
Vichyssoise cup	219 238 274
Vinegar dispenser	219 239 242 268
Water pitcher	199 291 292 294
Water pitcher, insulated	291 292
Wine cooler	304 305 307
Wine cooler stand	126 128 135 153 222 232 233 302 303 304 305 306 307 309 315
Wine holder	211 277
Wok	333 337
Yogurt cooler	210 223

Index

A B

Accessoires	82 <> 107
Ardoise	242
Assiette de bienvenue	134 146 149 151 165 186 194 257
	263 264 266 283 346
Batteries de cuisine	334
Beurrir	144 225 239 277 288
Bol	125 126 128 129 130 135 146 149
	150 151 152 153 155 172 174 176
	177 182 186 193 195 202 218 234
	235 237 259 262 263 265 280 342
	346
Bol à caviar	219 238
Bol à champagne	223 227 301
Bol à punch	223 227 301
Bol à rafraîchir	210 223
Bol à salade de fruits	146 216 237 249 342 346
Bol à sauce	280
Bol à snacks	219 287 342 343
Bol avec socle	146 147 216 218 223 237 301
Bol en bois	277
Bol en polycarbonate	135 309 310 340 342 343
Bol en polypropylène	346
Bol en verre	218 249
Bol universel	102 178
Boston shaker	301
Bouilleur	209
Bouilloire à lait	337
Borne étouffoir	154
Bouteille thermique	368 <> 371
Brasero avec pierres naturelles	242 244
But de canapé	308

C

Cache eau mineral	279
Cafetière	220 291 292 294 295 296
Cafetière thermique	291 292 296
Carafe	199 291 292 294
Carafe à eau	199 291 292 294
Carafe à eau thermique	291 292
Cartouches eutectiques	358 359
Casse-noix	282
Cendrier	151 154 276
Cendrier à cigares	151 154 276
Centre de table/Comptoir	155 158 159 161 189 202
Chafing-dish	208 210
Chandelier	221 227
Chandelier/bougeoir	227
Chariot	348 <> 363
Chariot de service	229
Chopsticks	82
Cloche pour plat	221 223 224 236 251 273 276 281
Cloche pour plat ovale	272
Cloche pour plat rond	221 236 251 273 276
Cloche support à tartes	224 236 281
Coffee Urn	209
Conteneur à thé	220 291 292 294 295 296
Coquetier	147 276
Corbeille	125 126 128 129 130 135 146 149
	150 151 152 153 155 172 174 176
	177 182 186 193 195 202 218 234
	235 237 259 262 263 265 280 342
	346
Corbeille à pain	135 146 149 150 151 186 193 195
	218 234 235 237 259 262 265 280
	342
Corbeille pour aromatiques condiments	135 262 277 280
Corps de chauffe électrique	208
Coupe à beurre	144 225 239 264 267 277 288
Coupe à caviar	219 238
Coupe à creme/potage	274
Coupe à crevettes	219 238
Coupe à fruits	147 180 182 225 237 238 280 288
	341
Coupe à glace	147 180 182 225 237 238 280 288
	341
Coupe à intermezzo	100 278
Coupe à Martini	278 341
Coupe à punch	223 227 301
Coupe à suprême	219 238
Coupe à vichyssoise	219 238 274
Coupe multifonctions	218
Coupe sur pied	146 147 216 218 223 237 301
Coupe thermique à glaze	237 280 288
Coupelle	102 149 150 151 178 202 216 237
	276 277 342 343 346
Coupe-truffes	283
Couteau à huîtres	160
Couteau à servir poisson	14 <> 72 106 119
Couteaux	14 <> 72 86 88 104 118 160
	243
Couvercle	224 272 274
Couvercle légumier	224 274
Couverts	14 <> 72 86 88 96 98 102
	104 106 118 119 160 163 176 206
	209 210 243 274 282 299 301
Couvre-plat	270 273

C

Crémier	154 248 288 299
Cuiller à bar	14 <> 72 104 106 299 316
Cuillère à miel	98
Cuiller à risotto	104 106 119 209 210
Cuiller à servir	14 <> 72 104 106 119 209 210
Cuiller à soda	14 <> 72 104 106 299 316
Cuillèr cocktail	14 <> 72 102 206
Cuillère à glace	14 <> 72 104 106 299 316
Cuillère à parmesan	14 <> 72
Cuillère à sauce	14 <> 72 119 210 274
Cuillère à sel	102 206
Cuillère monoportion	102 172
Cuillère multifonctionnelle	96 163
Cuit pâtes	337
Curette à homard	94 104

DEF

Décapsuleur	282
Dessous de bouteille	185 186 195 257 264 267 283
Dessous de verre	257 264 267
Distributeur à jus	209
Distributeur à lait	209
Distributeur de serviettes	192 193 234 258 289 298
Doseur	301
Douser sel/poivre	154
Ecuelle	146 276
Élément pour cuit pâtes	337
Étagère	158 159 160 177 182 216 217 223
	227 231 266
Étiquettes	185 223 237 278 281
Faitout	322 324 326 331 334
Finger food	102 106 133 162 <> 167 172 176
	185 195 202 206 212
Fourchette amouse-bouche	102 172 176 206
Fourchette à escargots	104
Fourchette à fromage	104
Fourchette à huîtres	14 <> 72
Fourchette à servir	14 <> 72 104 106 119 209 210
Fourchette à servir poisson	14 <> 72 106 119
Fourchette cocktail	102 172 176 206
Fourchette monoportion	102 172 176 206
Fromagère	133 219 239 259 260 262 263 265
	269 276

GHIL

Glacette thermique	304
Glaçon lumineux	317
Golfrosse pour cocktail	104 316
Gril	333
Huiliér	219 239 242 268
Huillier/vinaigrier	133 225 239 259 260 262 263 265
	268 269
Légumier	224 274
Légumier escoffier	274 0
Louche	14 <> 72 106 210 301

MNO

Marmite traiteur	322 324 326 331 334
Ménagère	133 225 239 259 260 262 263 265
	268 269
Mesure à alcool, double	301
Micro fourchette	102 172 176
Mini corbeille	177
Mini faitoute	322 324 326
Mini marquer de table	281
Mini spoon	102 206
Mini plateau	164 181 182 183 202 220
Mini vaporisateur	166
Moulin à herbes	283
Moulin à piment	283
Moulin à poivre	283
Moulin à sel	283
Mug	343
Numéro de table	186 223 237 278 281
Ouvre-bouteilles	282

PQ

Panier à fruits	135 146 149 150 151 152 153 155
	234 237 262 265 308 309 342 346
Passoire	337
Passoire à cocktail	282
Pelle à gâteau / à tarte	14 <> 72 106 118 209 210
Petit sous-plat	149 171 176 238 267 301 343
Petite marmite	208
Petite plateau	164 181 182 183 202 220
Pied pour bol a champagne	311
Pied pour seau à champagne	126 128 135 153 222 232 233 302
	303 304 305 306 307 309 315
Pince	104 147 212 275 276 293 316
Pince à amuse-bouche	212 293
Pince à asperges	147 212 275
Pince à escargots	104 275 276
Pince à fruits	212 275
Pince à glace	212 275 316
Pince à glaçon et citron	212
Pince à homard	104

Index

P Q

	Pag
Pince à hors-d'oeuvres et pâtisserie	212 275 293
Pince à légumes	147 212 275
Pince à pain et pâtisserie	212
Pince à pâtisserie	212
Pince à rôti	147 212 275
Pince à servir	212
Pince à spaghetti	147 212 275
Pince à sucre	212 275 293
Pince à sucre et apéritifs	212 293
Pince à tarte	212 275
Pince à toast et tarte	212 275
Pince fonde pour servir	212
Pince plaine pour servir	212
Plaque à induction	208
Plat à escargots	276
Plat à huîtres	158 159 161
Plat à oeuf	144 277
Plat à pain	149 267
Plat à poisson	144 270
Plat à présentation	134 146 149 151 165 186 194 257 263 264 266 283 346
Plat oval	144 146 270 272
Plat rond	144 151 206 251 270 272 340
Plateau	123 133 134 144 150 158 159 161 164 165 175 177 179 180 181 182 185 186 189 192 194 195 202 206 209 215 218 228 229 230 234 235 236 254 257 260 262 263 264 272 273 279 280 288 289 298
Plateau à hors d'oeuvre	248 258
Plateau à monnaie	176 301
Plateau avec trousse	177
Plateau carré	134 150 158 164 165 185 195 202 229 257 262
Plateau concave	279
Plateau en fibre de carbone	122 123
Plateau gn	185 186 194 215 228
Plateau ovale	150 159 164 189 218 230 263 273
Plateau porte verres empilable	235
Plateau pour chariot porte-plateau	186 235 254
Plateau rond	159 161 175 177 215 218 229 230 236 257 260 264
Plateau, rectangulaire	123 133 134 144 150 158 164 185 186 189 192 194 195 202 206 209 215 218 228 229 230 234 235 236 254 257 260 262 263 264 272 273 279 280 288 289 298
Poêle	323 325 327 331 332 336
Poivrier	154
Porcelaine	249 258
Porte brosse à dents	301
Porte confitures	225 269 299
Porte craquelins	178
Porte cure-dents	185 195 219 225 234 239 268 269 274 280
Porte gobelets	259
Porte gressin	151 178 186 193 195 279
Porte macarons	219 267 288
Porte noyaux	133 236
Porte petits fours	216 217 227 266 288
Porte pommes frites	165 242 278
Porte savon	299
Porte serviette	299
Porte-appetizers	219 287 342 343
Porte-badge	281
Porte-bouteille	277 279
Porte-pate/beurre/caviar	144 225 239 288
Porte-surprises	170 176
Porte toast	278 288
Pot à cuillères	301
Pot à lait	220 291 292 294 295 296 337
Pot à sucre	147 154 220 291 292 294 295 296 298 299
Presentoire	163 221 227 287 288 289
Quarta Posata	90 <> 93 163 175

R S

Râpe	282
Rafraîchisseur à bouteille	304
Rafraîchissoir à yogourt	210 223
Ravier à parmesan	133 219 239 259 260 262 263 265 269 276
Rechaud à cafe	209
Rince doigts	146 276
Saladier	146 216 237 249 342 346
Salière	219 269
Saucière	144 274
Sauteuse	246
Seau à champagne	126 146 152 153 186 222 232 301 302 303 304 305 306 307 308 309 310 314 316 317 342 346
Seau à glace	146 152 153 222 232 301 302 303 304 305 306 308 314 316 317 346
Seau à glace, thermique	232 304 305 306
Seau à vin	126 146 152 153 186 222 232 301 302 303 304 305 306 307 308 309

R S

Seau à vin	310 314 316 317 342 346
Service à caviar	238
Set de table	134 138 140 185 194
Set pinzimonio	249
Set pour Amouse bouche	133
Set pour ceviche	281
Set salière, poivrier	154 219 225 239 268 269 274
Shaker	301
Soliflore	283
Soupière avec couvercle	208 224 274
Sous plat	134 146 149 151 165 186 194 257 263 264 266 283 346
Sous bouteille	185 186 195 257 264 267 283
Sous verre	257 264 267
Soutier de sacs	284
Soutier porte-couverts	84 102 173 177 195 209
Stands de buffet	196 197
Street Cover	138 140
Sucrier	147 154 220 291 292 294 295 296 298 299
Support	248 249
Support à tarte	173 177 216 230 266
Support avec numéro de table	185 223 237 278 281
Support pour seau à champagne / à vin	126 128 135 153 222 232 233 302 303 304 305 306 307 309 315
Support pour tacos	279
Support pour toast	278 288

T V W

Tasse	343
Théière	220 291 292 294 295 296
Théière thermique	296
Tiffin box	252
Tire-bouchon	282
Tumbler	178
Vase	171 176 346
Vase à fleurs	283
Verre	154 178 202 206 340 341 346
Verseur de parfum en gouttes	225
Vinaigre	219 239 242 268
Vitrine réfrigérée	358 359
Wok	333 337

Alphabetisches Register

A B C

	Pag
Aderhalter	133 236
Ascher	151 154 276
Ascherständer	154
Auflaufform auf Porzellan	249 258
Austernöffner	160
Badge-Halter	281
Bargestell	219 287 342 343
Beilagenschale	146 276
Beutelstand	284
Bierbecher	341
Blumenvase	283
Bonbonsschale	170 176 265
Boston Shaker	301
Bowlenlöffel	301
Bratenplatte	144 270
Bratentopf	322 324 326 331 334
Bratpfanne	323 325 327 331 332 336
Brot Platte	149 267
Brotkorb	135 146 149 150 151 186 193 195 218 234 235 237 259 262 265 280 342
Brottschale	135 146 149 150 151 186 193 195 218 234 235 237 259 262 265 280 342
Buffet Display	202
Buffetständer	196 197
Buffet-Tablett	122 123 134 150 158 159 161 182 185 186 189 192 194 195 202 206 209 215 218 220 223 228 229 230 235 236 254 262 263 264 270 279 280 340
Butterdose	144 225 239 277 288
Butterkühler	264 267
Café au Lait-Set	224 293
Cappuccinolöffel	104 299
Cevichese	281
Chafing dish	208 210
Chafing dish besteck	209 210
Champagner Bowl	152 223 233 310 314 315
Champagner Bowlständer	311
Champagnerflaschenhalter	211
Champagnerglas	206 341
Chilimühle	283
Chillcup	219 238
Cocktailsieb	282
Coffee Urn	209
Cracker Schale	178

DEF

Deckel	224 272 274
Dessertgestell	221 287
Dressingbehälter	144 274
Dressinglöffel	14 <> 72 119 210 274
Eierbecher-Set	144 277
Eierlöffel	14 <> 72
Eierpfanne	147 276
Einsatz Tablett	133 165
Eis- und Zitronenzange	212
Eisbecher	147 180 182 225 237 238 280 288 341
Eisfruchtbecher, Isoliert	237 280 288
Eisgefäß	146 152 153 222 232 301 302 303 304 305 306 308 314 316 317 346
Eisgefäß, Isoliert	232 304 305 306
Eislöffel	14 <> 72 104 106 299 316
Eisschale	238
Eisschaufel	14 <> 72
Eiswasserkrug	199 291 292 294
Eiswürfel LED	317
Eiszange	212 275 316
Essig-/Ölflasche	219 239 242 268
Essig-/Ölflaschenhalter	135 262 277 280
Essig-/Ölgestell	225 239 268 269
Essig-/Öl-Menage	133 225 239 259 260 262 263 265 268 269
Ess-Stäbchen Paar	82
Ess-Stäbchen Ablage	82
Etagère	158 159 160 177 216 217 223 227 231 266
Feuerschale	242 244
Fingerfoodzange	212
Fingerfood-/Vorspeisen-/Butter-Gefäß	102 133 151 164 165 178 202 206 218 219 236 238 242 264 267 277 278 342 343
Fingerschale	146 276
Fischplatte	144 270
Flachzange zum Servieren	212
Flasche, Isoliert	368 <> 371
Flaschenhalter	277 279
Flaschenteller	185 186 195 257 264 267 283
Fleischgabel	14 <> 72 104 106 119 209 210
Früchtekorb	135 146 149 150 151 152 153 155 234 237 262 265 308 309 342 346
Frühstück Tablett	133

G H K

	Pag
Gebäckplatte	144 273
Gebäck- und Servierzange	212 276
Gemüseseiher	337
Gemüsetopf	337
Getränkekühler	154 209 210 233 291 292 304 315
Gewürzmenage	269
Gewürzständer	258
Glas	154 178 202 206 340 341 346
Glassflasche	219 239 242 268
Glaskrug	199
Glasschale	218 249
Glasuntersatz	257 264 267
Golf Schleger	104 316
Gratinplatte	144 272 273
Griffschale	129 130 149
Grifftablett	130 149
Grill Pfanne	333
Grissini-Halter	151 178 186 193 195 279
Gueridon	308
Happy Spoon	106
Heizelement	208
Honiglöffel	98
Hummergabel	94 104
Hummerzange	104
Innenteil für Spaghettitopf	337
Kaffeekanne	220 291 292 294 295 296
Kaffeekanne, isoliert	291 292 296
Kaffeespender	209
Kaffeetablett	298
Kartenhalter	223 237
Kartoffenbehälter	165 242 278
Kartoffellöffel	14 <> 72
Kasserolle	322 324 326 331 334
Kaviarkühler	219 238
Kaviarlöffel	282
Kaviarschale	219 238
Korkenheber	282
Korkenzieher	282
Kuchen-/Tortenplatte	218 230
Käsedose	133 219 239 259 260 262 263 265 269 276
Käsemesser	14 <> 72
Kohlefaser-Tablett	122 123
Kühlschale	158 159 160 161 210 223
Kühlvitrine	358 359

LMN

Latte Macchiato-Set	299
Légumier	146 224 272 274
Leuchter	221 227
Löffelbecher	301
Macaronsträger	219 267 288
Marmeladegestell	225 269 299
Martini Glass	278 341
Milchdispenser	209
Milchkaffee-Set	224 293
Milchkanne	220 291 292 294 295 296
Milchkännchen	154 248 288 299
Milch-Kaffee-Zucker-Set	224 293
Milchkocher	337
Mikrogabel	102 172 176
Mini Bratentopf	322 324 326
Mini Butterdose	144 225 239 277 288
Mini Gabel	102 206
Mini Schale	177
Mini Spoon	102 206
Mini Tablett	164 181 182 183 202 220
Mini Verdampfer	166
Mokkaétagère	182 217 227 266
Mug	343
Multifunktionaler Löffel	96 163
Nussknacker	282

OPQ

Obstschale	146 150 151 155 158 159 161 189 202 216 218 220 230 237 262 263 265 280 340 343 346
Papierbecherständer	259
Patisserie Tablett	192 234 235 289 298
Petits Fours-Ständer	173 177 216 217 220 221 227 266 288
Petits Fours-Tablett	179 180 181 182 183
Pfeffermühle	283
Pfefferstreuer	154
Platten	144 149 149 193 218 230 235 238 248 258 267 270 272 273 276 299
Platzteller	134 146 149 151 165 186 194 257 263 264 266 283 346
Portionsschöpfer	14 <> 72 106 210 301
Porzellanschale	249 258
Presentoire	163 221 227 287 288 289
Punchbowl	223 227 301
Quarta Posata	90 <> 93 163 175

RS

Reibe	282
-------	-----

Alphabetisches Register

RS	Pag
Reislöffel	104 106 119 209 210
Relish-Pickles-Gestell	219 287 342 343
Rotweinwiege	277
Saftdispenser	209
Saftkrug	199 291 292 294
Sahne-/Zucker-Set	224 293
Sahnegießer	154 248 288 299
Sahnekännchen	147 293
Salat-/Vorlegebesteck	14 <> 72 106 119 209 210
Salatzange	147 212 275
Salz- und Pfeffergestell	154 225 239 268 269 274
Salzmühle	283
Sauce Set	280
Saucenlöffel	14 <> 72 119 210 274
Sauciere	144 178
Sauteuse	246
Schale	125 126 128 129 130 135 146 149 150 151 152 153 155 172 174 176 177 182 186 193 195 202 218 234 235 237 259 262 263 265 280 342 346
Schalenhalter	248 249
Schmuckablage	170 176
Schnapsbecher	341
Schneckengabel	104
Schneckenzange	104 275 276
Schneckenplatte	276
Serviergestell	221 287
Serviertablett	123 133 134 144 150 158 159 161 164 165 175 177 179 180 181 182 185 186 189 192 194 195 202 206 209 215 218 228 229 230 234 235 236 254 257 260 262 263 264 272 273 279 280 288 289 298
Servierwagen	348 <> 363
Serviettenhalter	192 193 234 258 289 298
Serviettenring	130 259
Set mit Porzellanschale	258
Shot Glass	154
Snackschale	277
Sorbetschale	100 278
Spaghettitopf	337
Speckstein	242
Speisekartenhalter	223 237
Stand für Plastik Platte	259
Stapelbare Gläserträger Tablett	235
Steakmessern	14 <> 72 86 88 243
Stielkasserolle	322 324 326 331 334
Suppenmarmite	208
Suppenschöpfer	14 <> 72 106 301
Suppenstation	208
Suppentasse	274
Suppenterrine	224 274
Street Cover	138 140
Strohalm Halter	316

T	
Tablett	123 133 134 144 150 158 159 161 164 165 175 177 179 180 181 182 185 186 189 192 194 195 202 206 209 215 218 228 229 230 234 235 236 254 257 260 262 263 264 272 273 279 280 288 289 298
Tablett Gastronorm	185 186 194 215 228
Tablett für Rack	186 235 254
Tablett für Stoffservietten	299
Tablett, konkave	279
Tablett, oval	150 159 164 189 218 230 263 273
Tablett, quadratisch	134 150 158 164 165 185 195 202 229 257 262
Tablett, rechteckig	123 133 134 144 150 158 164 185 186 189 192 194 195 202 206 209 215 218 228 229 230 234 235 236 254 257 260 262 263 264 272 273 279 280 288 289 298
Tablett, rund	159 161 175 177 215 218 229 230 236 257 260 264
Tacoshalter	279
Tafelaufsatz	155 158 159 161 189 202
Teeglas	202
Teekanne	220 291 292 294 295 296
Teekanne, Isoliert	296
Teller	146 251 272
Teller cloche	221 223 224 236 251 273 276 281
Thermische Ringröhre	249 251
Tiefzange zum Servieren	212
Tiffin box	252
Tischnummer	185 223 237 278 281
Tischnummernständer	185 223 237 278 281
Tischnummern-Aufsteller	223 237 281
Tischrestebehälter	151 176 301
Tischset	134 140 185 194
Toastständer	278 288
Tortenheber	14 <> 72 106 118 209 210
Tranchiergabel	14 <> 72 104 106 119 209 210
Tranchiermesser	14 <> 72 86 88 243

T	Pag
Tropf-Parfüm Aussteller	225
Trüffel Hobel	283
Tumbler	178
U V W	
Universalschale	146 216 237 342 343 346
Universalschale auf Holz	277
Universalträger	170 176
Vorspeisenplatte	248 258
Vorspeisen Set	133
Yogurtkühler	210 223
Warmhalteteller	251
Wasserascher	151
Weinbecher	206 340 341
Wein-/Sekt Kühler	126 146 152 153 186 222 232 301 302 303 304 305 306 307 308 309 310 314 316 317 342 346
Weinkühler	304 305
Weinkühlerständer	126 128 135 153 222 232 233 302 303 304 305 306 307 309 315
Whisky Becher	341
Wokpfanne	333 337
Z	
Zahlsteller	151
Zahnstocherbehälter	185 195 219 225 234 239 268 269 274 280
Zucker- und Cocktailszange	212 293
Zuckerdose	147 154 220 291 292 294 295 296 298 299
Zuckergestell	224 225 287 293
Zuckerständer	267
Zuckerstangengefäß	193 220 234 289 296 298 299
Zuckerzange	212 275 293

Indice

A B	Pág.
Abrebotellas	282
Accesorios	82 <> 107
Aceitera	219 239 242 268
Apoyo para bolsas	284
Apoyo para chopsticks	82
Apoyo para cubiertos	84 102 173 177 195 209
Azucarera	193 220 234 289 296 298 299
Azucarero	147 154 220 291 292 294 295 296 298 299
Bac rond	258
Bajo plato	134 146 149 151 165 186 194 257 263 264 266 283 346
Bandeja	123 133 134 144 150 158 159 161 164 165 175 177 179 180 181 182 185 186 189 192 194 195 202 206 209 215 218 228 229 230 234 235 236 236 254 257 260 262 263 264 272 273 279 280 288 289 298
Bandeja con agujeros	177
Bandeja concavo	279
Bandeja cuadrada	134 150 158 164 165 185 195 202 229 257 262
Bandeja cuentas y propinas	176 301
Bandeja de fibra de carbono	122 123
Bandeja gn	185 186 194 215 228
Bandeja para estantes	186 235 254
Bandeja portaservilletas	299
Bandeja portavasos impilable	235
Bandeja rectangular	123 133 134 144 150 158 164 185 186 189 192 194 195 202 206 209 215 218 228 229 230 234 235 236 254 257 260 262 263 264 272 273 279 280 288 289 298
Bandeja redonda	159 161 175 177 215 218 229 230 236 257 260 264
Bandeja tartas	218 230
Baterias de cocina & accesorios	330
Bistequera	333
Bobina térmica	249 251
Bol à salade de fruits	146 216 237 309 342 346
Bol para caviar	219 238
Bol para limpiar dedos	146 276
Botella	242
Botella térmica	368 <> 371
C	
Cacerola	322 324 326 331 334
Cafetera	220 291 292 294 295 296
Cafetera térmica	291 292 296
Calentador de café	209
Calientador à inducción	208
Calientador eléctrico	208
Candelabro	221 227
Carros	348 <> 362
Cascanueces	282
Cazo	14 <> 72 106 301
Cenicero	151 154 276
Cenicero a columna	154
Centro mesa	155 158 159 161 189 202
Cesta	125 126 128 129 130 135 146 149 150 151 152 153 155 172 174 176 177 182 186 193 195 202 218 234 235 237 259 262 263 265 280 342 346
Cesta pan	135 146 149 150 151 186 193 195 218 234 235 237 259 262 265 280 342
Cesta para fruta	135 146 149 150 151 152 153 155 234 237 262 265 308 309 342 346
Cesto por aromaticos y condimentos	135 262 277 280
Cevichera	281
Chafing-dish	208 210
Chop sticks	82
Coctelera	301
Coctelera con vaso	301
Colador para cóctel	282
Colador para olla pastas	337
Columna porta cesta champany	311
Columna porta cubo champany	126 128 135 153 222 232 233 302 303 304 305 306 307 309 315
Contenedor para café	199 209
Contenedor para zumo de fruta	199 209
Contenedor sobres té	193 220 234 289 296 298 299
Copa caviar	219 238
Copa cóctel camarones	219 238
Copa con base	146 147 216 218 223 237 301
Copa de vidrio	218
Copa gazpacho/potage	274
Copa helado y macedonia	147 180 182 225 237 238 280 288 341
Copa mantequilla	219 238
Copa para intermezzo	100 278
Copa salsa	144 178 274
Copa soufflé	144 178 274
Copa térmica	237 280 288
Copa universal	102 178 0

C	Pág.
Copa vichyssoise	219 238 274
Copita	102 178 180 182 225
Cortador de trufas	283
Cuberteria	14 <> 72 86 88 96 98 102 104 106 118 119 160 163 176 206 209 210 243 274 282 299 301
Cubitera de champaña	152 223 233 310 314 315
Cubitera hielo	146 152 153 222 232 301 302 303 304 305 306 308 314 316 317 346
Cubitera hielo térmica	232 304 305 306
Cubito hielo LED	317
Cubo de champagne gigante	310
Cubo vino	126 146 152 153 186 222 232 301 302 303 304 305 306 307 308 309 310 314 316 317 342 346
Cubreplatos ovales	272 273
Cubreplatos, redondo	251 270 273
Cuchara arroz	104 106 119 209 210
Cuchara cocktail	14 <> 72 102 206
Cuchara de miel	98
Cuchara ensalada	14 <> 72 106 119 209 210
Cuchara multifuncional	96 163
Cuchara parmesán	14 <> 72
Cuchara servir	14 <> 72 104 106 119 209 210
Cucharita cappuccino	104 299
Cucharita caviar	282
Cucharita mezcladora	14 <> 72 104 106 299 316
Cucharita para sal	102 206
Cuchillo ostras	160
Cuchillo servir pescado	14 <> 72 102 115
Cuchillos	14 <> 72 86 88 104 118 160 243
Cúpula cobre-platos	221 223 224 236 251 273 276 281
Cuenco	146 149 150 151 177 178 182 202 216 218 225 235 237 259 277 309 340 342 343 346
Cuenco con bandeja	178 2 182 225
Cuenco con pedestal	146 216 237
Cúpula refrigerada	358 359
D E F	
Dispensador	209
Dosador sal/pimienta	154
Ensaladera	146 216 237 249 342 346
Entremesera	248 258
Escurridera	337
Finger Food	102 106 133 162 <> 167 172 176 185 195 202 206 212
Florero	283
Frutero	155 158 159 161 189
Fuente de marisco	144 161 270
Fuente oval	144 146 270 272
Fuente para Lasagne	249 258
Fuente pescado	144 270
G H I J L	
Golf club cucharita coctél	104 316
Gueridon	308
Hoguera con piedras naturales	242 244
Huevera	144 277
Individual en acero	185 194
Individual en madera	134
Individual en goma	138 <> 141
Inserto por finger food	133 165
Jarra	147
Jarra agua	199
Jarra leche	220 291 292 294 295 296
Jarra térmica	291 292
Jarrita lechera	154 248 288 299
Joyerero	170 176
Juego azucar	225 267 287 293
Juego café au lait	293 299
Juego leche, café y azucar	293 299
Lavadodos	146 276
Legumbreira	224 274
Legumbreira escoffier	274
M N O	
Mantèl individual	134 138 <> 140 185 194
Mantequillera	277 299
Marmeladero	225 269 299
Medida bar, doble	301
Micro tenedor	102 172 176
Mini bandeja	164 181 182 183 202 220
Mini cacerola	322 324 326
Mini cuenco	177
Mini spoon	102 206
Mini tenedor	102 206
Mini vaporizador	166
Molinillo chile	283
Molinillo hierbas	283
Molinillo pimienta	283
Molinillo sal	283
Mug	343
Número de mesa	185 223 237 278 281
Olla para pastas	337

Indice

P Q	Pág.
Pala para tarta	14 <> 72 106 118 209 210
Pala pescado	14 <> 72 106 119
Palillero	185 195 219 225 234 239 268
	269 274 280
Panera	135 151 186 193 195 218 234 235
	259 265 280 342
Pedestal para tarta	173 177 216 217 220 221 227 266
	288
Petit marmite	208
Pimentero	154 225 239 268 269 274
Pinzas asados y verduras	147 212 275
Pinzas azucar	212 275 293
Pinzas azucar y aperitivos	212 293
Pinzas caracoles	104 275 276
Pinzas entremeses y pasteles	212 275
Pinzas espagueti	147 212 275
Pinzas espárragos	147 212 275
Pinzas frutas	212 275
Pinzas fundas para servir	212
Pinzas hielo	212 275 316
Pinzas hielo y limón	212
Pinzas llanas para servir	212
Pinzas pan y pasteles	212
Pinzas pasteles	212 275
Pinzas pasteles y tostadas	212 275
Pinzas por finger food	212
Pinzas servir	212
Pinzas verduras	147 212 275
Pinzimonio	249
Pizarra	242
Plancha refrigerada	358 359
Platillo para mantequilla	264 267
Platito bajo botellas	185 186 195 257 264 267 283
Platito bajo vasos	257 264 267
Plato caracoles	276
Plato concavo	193 235
Plato de presentación	134 146 149 151 165 186 194 257
	263 264 266 283 346
Plato huevos	147 276
Plato ostras	158 159 161
Plato para pan	149 267
Plato térmico	251
Ponchera	223 227 301
Porcelana	249 258
Porta bastoncillos de pan	151 178 186 193 195 279
Porta botellas	277 279
Porta cepillo de dientes	301
Porta cucharitas	301
Porta dulces	216 217 227 266 288
Porta galletas saladas	178
Porta granos	133 236
Porta jabón	299
Porta informaciones	223 237
Porta macaron	219 267 288
Porta numero de mesa	185 223 237 278 281
Porta palillas	185 195 219 225 234 239 268
	269 274 280
Porta patatas fritas	165 242 278
Porta pescado	158 159 160 223 231
Porta servilletas	192 193 234 258 289 298
Porta sorpresas	170 176
Porta Tacos	279
Porta tarjeta	281
Porta tostadas	278 288
Porta vasos	259
Portapan	151 178 185 186 193 195 279
Portaplatos de plastica	259
Posabotella	185 186 195 257 264 267 283
Posavaso	257 264 267
Posavaso por mug	343
Pote leche	337
Presentoire	163 221 227 287 288 289
Puerto paté/mantequilla/caviar	225 269 299
Quarta Posata	90 <> 93 163 175
Quesera	133 219 239 259 260 262 263 265
	269 276

R S

Rallador	282
Refrigerador para yogurt	210 223
Rompenueces	282
Salero y pimentero	154 225 239 268 269 274
Salsera	144 274
Saucière	144 178
Sauteuse	246
Servicio para aperitivos	133
Servicio para buffet	202 206
Servicio para café con leche	224 293
Servicio para caviar	238
Servicio para champagne	305
Servicio para ensaladas	249
Servicio para Lasagne	249 258
Servicio para salsa	280
Servicio por aromaticos y condimentos	135 262 277 280
Servicio por entremes	219
Servilletero	130 259

R S

R S	Pág.
Sopera	208 224 274
Soportes de buffet	196 197
Soporte platos	221 287
Soporte multi usos	248 249
Street cover	138 140

T V W

Tapa	224 272 274
Tapa legumbrera y sopera	224 274
Tarjetas	185 223 237 278 281
Tazas	343
Tenedor caracoles	104
Tenedor cocktail	102 172 176 206
Tenedor diápasón	104
Tenedor ensalada	14 <> 72 106 119 209 210
Tenedor langostas	94 104
Tenedor ostras	14 <> 72
Tenedor pescado	14 <> 72 106 119
Tenedor servir	14 <> 72 104 106 119 209 210
Tetera	220 291 292 294 295 296
Tetera térmica	296
Tiffin box	252
Tumbler	178
Vaso	154 178 202 206 340 341 346
Versador de perfume en gotas	225
Vinagrera	219 239 242 268
Vinagreras con saleros	133 225 239 259 260 262 263 265
	268 269
Wok	333 337

Index

	Pag	Pag	Pag	Pag	Pag	Pag					
025	282	260	176	418	185	548	301	666C	153	729	301
03180	349	260	242	418	194	549	164	666C	309	730	152
03280	349	262G	159	419	186	549	202	666CMG	128	730	314
03680	349	262	159	419	194	550	343	666E	232	737	182
03780	349	264	280	420	185	551	301	666E	306	737	183
041104	353	270	192	420	194	552	343	666F	222	738	178
042104	353	270	234	421	102	553	340	666F	302	739	177
046104	353	272A	251	422	185	554	340	666H	303	740	102
047	282	272B	251	422	195	555N	206	666HMG	128	740	178
047104	353	272C	251	423	102	555	340	666I	233	742	179
048	282	273A	251	423	185	557	150	666I	315	742	181
049	282	273B	251	423	195	557	189	666K	311	742	182
051104	352	280	281	424	102	558	150	666L	307	743	176
052104	352	281	281	424	234	558G	159	666M	307	744	172
056104	352	289	165	425	252	558V	159	666MG	126	744	176
057104	352	289	242	426	185	559	151	666W	308	744	193
09150	349	289	242	427	186	561	150	666Z	308	745	179
09250	349	289	278	427	195	561	189	668MG	126	745	180
094	280	292	267	428	186	562	150	668	232	745	181
098	280	293	266	428	194	562G	158	668	306	745	182
09841	280	301	238	429	186	562V	158	669	232	746	181
099	346	301A	238	430	186	567	151	669	306	746	182
105	267	301C	238	430	307	568	151	669MG	126	746	183
106	267	301B	238	438	152	569	151	670	298	747	180
133	283	304	269	438	317	570	154	671	283	747	182
140	229	306	259	439	152	570	248	672	305	748	170
140K	229	307	259	439	317	571	154	674	233	748	176
141GN	228	308	259	446	278	574	248	674	315	749	172
144GN	228	309	268	447N	283	575	248	675	279	749	176
144GN2	228	310	259	451	278	576	249	675P	279	750	102
146GN	228	312	268	451	288	579	249	676	304	750	172
151	209	313	257	462N	283	580	249	678	305	750	176
152	279	315	257	464N	283	581	248	679	305	751	276
154	235	316	257	466N	283	582	248	680	305	752	276
155	133	317	259	473N	282	582	249	681	305	753	173
155	236	319	257	485	160	583	249	682	199	753	177
156	278	320	257	496AC	279	588P	206	683	316	754	175
163	133	321	259	497	268	588	340	684	316	754	177
168	260	323	257	498	239	590	343	685	233	755	284
169	260	324	268	499	299	591P	206	685	315	756	284
170	146	325	268	500	177	591	340	686	233	757	284
171	146	331	263	501	177	592	343	686	315	758	284
175	146	332	263	502	265	593	343	688	152	760	212
176	146	333	263	503	277	594	248	688	317	771	275
178	144	335	263	504	277	594	299	689	152	772	275
179	147	336	263	505	235	595	299	689	317	774	275
180	147	337	263	505	262	596	152	691	199	775	275
184	144	350	268	506	239	596	309	693	370	777	275
186	144	355	277	507	239	597	153	700	165	778	275
187	144	356	277	508	268	597	308	700	242	779	104
188	147	356	280	509	268	598	153	700	298	779	275
204	267	364A	296	510	268	598	308	702	239	779	276
205	192	364B	296	510	268	598	310	702	288	787	133
205	235	364T	296	510ST	268	599	135	703AC	171	789	134
205	289	370	303	511	274	599	152	703AC	176	789	134
206	192	371	303	511	274	599	309	703	299	791	134
206	235	380	316	512	269	599	309	704	193	791	134
206	289	381	316	512	269	599	342	704	234	791	165
206	298	382	196	513	239	601	269	704	289	791	165
208	267	382	275	513	239	602	269	704	298	791AC	133
209	264	382	316	514P	154	603	269	706	299	791AC	165
210	264	383	196	514S	154	604	269	707	277	791E	164
212A	189	384	197	516	193	605	342	708	301	793	133
212	189	385	197	516	234	606	343	709	281	794	133
220	227	386	197	516	289	607	153	711	277	795	134
222A	189	387	196	516	298	608	152	712	238	796	134
222	189	388	197	518	234	609	149	713	238	799N	277
225	358	389	197	520	164	611	269	714	238	799P	277
225	359	390	196	522	265	612	149	715	267	799W	277
229	280	391	196	523	177	616AC	149	716	264	804	135
230	280	403	185	525	239	617	149	717	178	844	265
232	279	403	194	526	288	620	242	718	178	870	151
235G	161	404	185	527	341	639	293	719	154	870	151
235	161	404	195	528	276	649	293	720	299	870	193
236	210	404	195	531	341	657	223	721	237	871	155
242	155	406	262	533	341	658	317	721	288	871	193
242G	160	407	262	534	341	660	305	722	238	872	178
24222G	160	408	262	535	341	661	301	723	238	874	146
252	158	409	262	536	341	662	304	725	238	878	147
252G	158	410	262	543N	206	663	304	727	100	879	147
254	237	411	262	543	341	664	304	727B	100	880	146
258	227	415	236	544	277	665	301	727N	100	881	147
258	288	416	185	545	301	666	304	727O	100	882	146
260	165	416	195	546	301	666A	305	727OI	100	883	337
260	171	417	186	547	301	666B	135	727	278	884	146

Index

	Pag	Pag	Pag	Pag	Pag	Pag					
886	346	982	218	7071	227	17440	144	24730	273	28450	236
888	346	982	220	7072	227	17726	144	24731	221	28460	236
891	346	983	223	7073	227	17731	144	24731	273	28730	230
892	346	984	221	7086	210	18130	144	24732	221	28740	230
899	153	984	287	7087	210	18140	144	24732	273	28750	230
899	314	985	221	7090	210	18235	144	24733	221	28760	230
901	278	985	287	7092	221	18240	144	24733	273	28830	230
902	165	986	223	7093	221	18514	146	25035	229	28840	230
902	242	987	223	7094	221	18520	146	25040	229	28850	230
902	298	988	225	7199	208	18524	146	25127	270	28860	230
903	278	989	221	7199A	208	19931	264	25130	270	29419	266
904	276	989	287	7199B	208	20130	264	25135	270	29424	266
905	279	990	180	7199C	208	20140	264	25140	270	29535	230
905P	279	990	182	7201	208	20150	264	25327	273	29645	230
906	82	990	225	7201A	208	20240	264	25335	223	29745	230
906	84	994A	237	7201B	208	20250	264	25335	273	29840	230
907	237	994B	237	7201C	208	20325	264	25340	273	30280	360
909	153	994C	281	7206	209	20331	264	25506	163	30538	257
909	314	995A	223	7208	209	20560	192	25506	288	30545	257
910	153	995B	223	10192	354	20560	235	25508	163	30980	360
910	314	996	278	10292	354	20560	289	25508	288	31440	279
911	276	998	277	10333	266	20660	192	25514	227	31455	279
912	153	999C	154	10335	266	20660	235	25514	289	31802	268
912	314	1001	130	10432	283	20660	289	25520	227	32250	362
913	281	1003	130	10692	354	20660	298	25520	289	32950	362
914	182	1004	130	10792	354	20724	234	25524	227	33298	361
914	183	1005	130	12150	350	20730	234	25524	289	33998	361
914	220	1006	130	12250	350	20734	234	25627	229	36101	296
915	84	1009	129	12650	350	21126	273	25635	229	36104	296
916	178	1010	129	12750	350	21131	273	25640	229	36106	296
918	178	1011	128	13132	266	22512	236	25714	227	36108	296
919	174	1012	128	13626	298	22512	281	25714	288	36110	296
919	177	1013	128	13760	229	22522	236	25720	227	36116	296
920	102	1014	128	13860	229	22522	281	25720	288	36202	296
920	173	1016	125	13960	229	22528	236	25728	227	36204	296
920	177	1017	125	14130	228	22528	281	25728	288	36206	296
922	225	1581	337	14135	228	23125	270	25920	237	36208	296
935	219	1591	337	14140	228	23130	270	25928	237	36301	296
935	288	2180	333	14145	228	23135	270	26202	155	36304	296
937	218	3100J	141	14150	228	23140	270	26202G	160	36306	296
938	218	3100S7	141	14160	228	23145	270	26203	155	36308	296
939	224	3101H7	141	14180	228	23150	270	26203G	160	36316	296
939	293	3101Q7	141	14190	359	23160	270	26204	155	36606	296
940	224	3102F7	141	14270	123	23330	270	26204G	160	36608	296
940	293	3102N7	141	14290	359	23335	270	26303	272	36704	296
940E	224	3200J	141	14440	228	23340	270	26403	272	36706	296
940E	293	3200S7	141	14445	228	23345	270	26524	192	42945	254
941	301	3201H7	141	14450	228	23350	270	26524	234	42963	254
941	316	3201Q7	141	14460	228	23535	272	26524	289	51610	234
942	225	3202F7	141	14480	228	23540	272	26530	192	51610	289
943	225	3202N7	141	14630	228	23635	272	26530	234	51710	346
943	225	3300J	141	14635	228	23640	272	26530	289	51722	346
947	225	3300S7	141	14640	228	23825	273	26534	192	51728	346
948	307	3301H7	141	14645	228	23830	273	26534	234	51755	346
949	223	3301Q7	141	14650	228	23835	273	26534	289	52405	288
956	276	3302F7	141	14660	228	23840	273	26602	272	52603	164
957	220	3302N7	141	14680	228	23845	273	26702	272	52604	164
958	218	3403F7	139	15014	193	24155	270	26820	273	52922	164
959	218	3403N7	139	15014	235	24170	270	26824	273	53012	166
960	218	3404J	139	15018	193	24202	155	26826	273	53022	166
963GN	215	3404S7	139	15018	235	24202G	160	26827	273	53706	160
968	219	3405H7	139	15020	193	24355	270	26828	273	53706	202
969	219	3405Q7	139	15020	235	24370	270	26830	273	53712	164
970	219	3503F7	139	15022	193	24530	273	26831	273	53712	202
971	219	3503N7	139	15022	235	24535	273	26833	273	55737	150
972	222	3504J	139	15024	193	24540	273	26928	270	55737	189
972P	222	3504S7	139	15024	235	24545	273	27228	251	55837	150
972	302	3505H7	139	15026	193	24550	273	27230	251	56012	151
972P	302	3505Q7	139	15026	235	24710	221	27233	251	56012	202
973	222	3600J	141	15028	193	24710	273	27328	251	56015	151
973P	222	3600S7	141	15028	235	24713	221	27330	251	56015	202
973	302	3601H7	141	15338	235	24713	273	27333	251	56022	151
973P	302	3601Q7	141	15338	254	24714	221	28215	242	56022G	159
974	221	3602F7	141	16190	358	24714	273	28215	244	56022V	159
975	219	3602N7	141	16290	358	24720	221	28222	242	56022	202
976	219	7001B	231	16440	260	24720	273	28222	244	56032	151
976C	219	7002B	231	16450	260	24722	221	28232	242	56032	202
976S	219	7003A	266	16535	260	24722	273	28232	244	56123	150
976C	287	7003B	266	17230	144	24724	221	28327	236	56123	189
976S	287	7004A	231	17240	144	24724	273	28335	236	56315	150
978	217	7004B	231	17250	144	24726	221	28340	236	56315	202
980B	217	7011	202	17355	144	24726	273	28430	236	56322	150
980A	217	7011E	202	17370	144	24728	221	28435	236	56322	202
981A	216	7012	206	17427	144	24728	273	28440	236	56415	150
981B	216	7070	227	17435	144	24730	221	28445	236	56422	150

Index

Pag		Pag		Pag		Pag		Pag		Pag	
56422G	158	64302	292	78850	134	96635	215	280122	324	10001175	84
56422V	158	64304	292	79230	134	96640	215	280124	324	10001175B	84
57220	242	64306	292	79250	134	96727	215	281109	324	10001175N	84
57234	242	64308	292	79715	135	96735	215	281114	324	10001175O	84
57262	242	64310	292	79720	135	96740	215	281116	324	10001175OI	84
58912	342	64312	292	83422	237	97413	287	282112	324	10001175	209
58922	342	64316	292	83434	237	97419	287	282120	324	10061101	118
58928	135	64402	292	84331	265	97713	216	282122	324	10061102	118
58928	309	64402P	292	86320	237	97719	216	282124	324	10061103	118
58928	342	64404	292	86420	237	97803	217	282128	324	10061104	118
58970	310	64404P	292	87504	147	98402	221	283124	324	10061105	118
59870	310	64406	292	87508	147	98402	287	283128	324	10061106	118
61322	149	64406P	292	92727	218	100222	130	284122	325	10061107	118
61340	149	64408	292	92735	218	100240	130	284126	325	10061110	119
61422	149	64408P	292	92740	218	120120	331	284130	325	10061111	119
61440	149	64504	292	92830	218	120124	331	290576	249	10061115	118
61739	149	64506	292	92835	218	121116	331	430350	239	10061116	118
62101	291	64512	292	92840	218	122120	331	430491	269	10061120	119
62102	291	64604	291	92845	218	122124	331	430491SS	269	10061121	119
62104	291	64606	291	92850	218	123128	331	430510SS	239	10061122	119
62106	291	64612	291	92860	218	124126	331	430510SS	239	10061123	119
62108	291	65102	295	93612	224	150008	334	430510ST	268	10061140	119
62110	291	65104	295	93622	224	150014	334	430511SS	274	10061142	119
62112	291	65106	295	93628	224	150120	334	430602	269	10101136	88
62116	291	65108	295	94003	225	150122	334	647150	292	10101136	243
62202	291	65110	295	94003	287	150124	334	648150	291	10131140	274
62204	291	65112	295	94003	293	151116	334	720411	209	10141136	88
62206	291	65116	295	94004	225	152120	334	720419	209	10141136	243
62208	291	65202	295	94004	287	152122	334	799906	211	10201110	210
62210	291	65204	295	94004	293	152124	334	799909	211	10201111	210
62301	291	65206	295	94005	224	153126	334	10001108	282	10201116	210
62302	291	65208	295	94005	293	153130	334	10001109	106	10201122	210
62304	291	65301	295	94414	224	157122	337	10001110	106	10201123	210
62306	291	65302	295	94418	224	157222	337	10001110	209	10201136	88
62308	291	65304	295	94420	224	157830	337	10001111	106	10201136	243
62310	291	65306	295	94422	224	157922	336	10001111	209	10201140	210
62312	291	65308	295	94424	224	157926	336	10001115	106	10201141	210
62316	291	65310	295	94426	224	157930	336	10001116	106	10201142	210
62402	291	65312	295	94428	224	180120	322	10001116	209	10201143	104
62402P	291	65316	295	94514	224	180120O	326	10001120	106	10201143	210
62404	291	65402	295	94518	224	180122	322	10001121	106	10201144	104
62404P	291	65404	295	94520	224	180122O	326	10001122	106	10201144	299
62406	291	65406	295	94522	224	180124	322	10001122	209	10231136	88
62406P	291	65408	295	94524	224	180124O	326	10001123	106	10231136	243
62408	291	67301	232	94526	224	181109	322	10001123	209	10341136	88
62408P	291	67301	306	94528	224	181109O	326	10001124	106	10341136	243
63102	294	67304	232	94614	224	181114	322	10001125	104	10341146	96
63104	294	67304	306	94618	224	181114O	326	10001126	104	10341146B	96
63106	294	67701	304	94620	224	181116	322	10001127	106	10341146N	96
63108	294	67704	304	94622	224	181116O	326	10001128	82	10341146O	96
63110	294	68702	199	94624	224	182112	322	10001128B	82	10341146OI	96
63112	294	69202	199	94626	224	182112O	326	10001128N	82	10341146	163
63116	294	70110	274	94628	224	182118	322	10001128O	82	10521108	102
63202	294	70115	274	95014	216	182118O	326	10001128OI	82	10521108	206
63204	294	70130	274	95020	216	182120	322	10001129	92	10521131	102
63206	294	72611	278	95024	216	182120O	326	10001129	163	10521131	206
63208	294	72620	278	95028	216	182122	322	10001129	175	10701136	88
63301	294	73112	274	95104	220	182122O	326	10001133	98	10711136	88
63302	294	73214	274	95106	220	182124	322	10001133B	98	TU0687G	199
63304	294	73218	274	95202	220	182124O	326	10001133N	98	TU0692V	199
63306	294	73220	274	95206	220	183124	322	10001133O	98		
63308	294	73222	274	95302	220	183124O	326	10001133OI	98		
63310	294	73224	274	95304	220	183128	322	10001136	88		
63312	294	73226	274	95406	220	183128O	326	10001136	243		
63316	294	73228	274	95613	276	184122	323	10001138	104		
63404	294	73614	274	96330	215	184122O	327	10001139	94		
63406	294	73618	274	96335	215	184126	323	10001139B	94		
63408	294	73620	274	96340	215	184126O	327	10001139N	94		
63510	294	73622	274	96345	215	184130	323	10001139O	94		
63516	294	73624	274	96350	215	184130O	327	10001139OI	94		
64101	292	73626	274	96360	215	213132	333	10001139	104		
64102	292	73628	274	96440	215	217828	333	10001140	104		
64104	292	74116	276	96445	215	217920	332	10001141	106		
64106	292	78125	246	96450	215	217924	332	10001142	106		
64108	292	78130	246	96460	215	217928	332	10001142	209		
64110	292	78135	246	96530	215	217932	332	10001144	86		
64112	292	78140	246	96535	215	247075	221	10001144B	86		
64116	292	78214	274	96540	215	247075	273	10001144N	86		
64202	292	78218	274	96545	215	247100	221	10001144O	86		
64204	292	78220	274	96550	215	247100	273	10001144OI	86		
64206	292	78222	274	96560	215	247132	221	10001144	243		
64208	292	78224	274	96613	215	247132	273	10001147	104		
64210	292	78226	274	96619	215	247145	221	10001150	104		
64300	292	78228	274	96624	215	247145	273	10001150	316		
64301	292	78830	134	96627	215	280120	324	10001151	301		



Ci mettiamo il cuore



HOTEL Catalog



www.mepra.it



HOTEL Catalog USA



25065 LUMEZZANE - BRESCIA - ITALIA - VIA MONTINI 176
TEL. 0308921441 - FAX 0308925075 - MEPRA@MEPRA.IT
WWW.MEPRA.COM